

MİMARİ KATALOG
ARCHITECTURAL CATALOGUE

Alüminyum Konvansiyonel Sistemleri
Aluminium Conventional Systems

DENİZLİK

DENİZLİK PROFİLLERİ

WINDOWSILL PROFILES

KOD / CODE	AĞIRLIK (kg/m) / WEIGHT	L m	KOD / CODE	AĞIRLIK (kg/m) / WEIGHT	L m
A003952	0,361	6	A003948	0,651	6
A003951	0,421	6	A003873	0,773	6
A003950	0,481	6	A003872	0,826	6
A003949	0,586	6	A003871	0,879	6

A003952

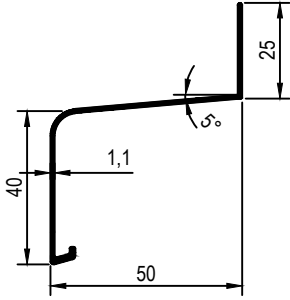

A003951

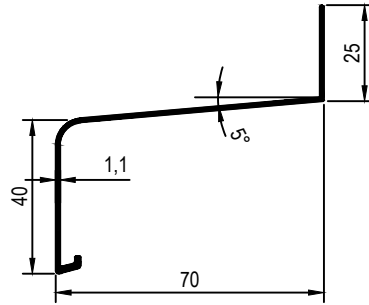

A003950

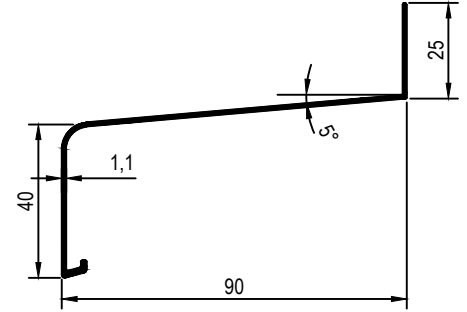

A003949

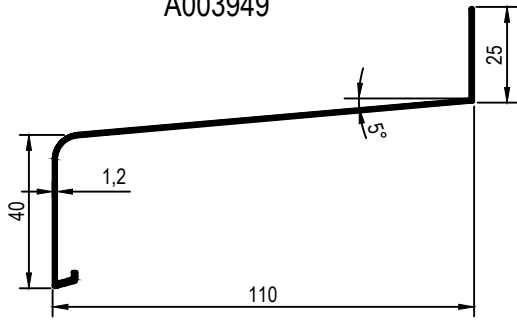

A003948

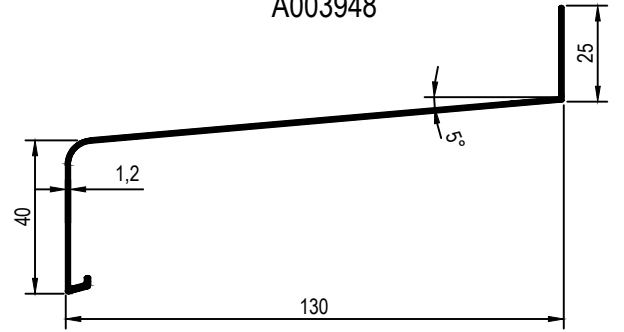

A003873

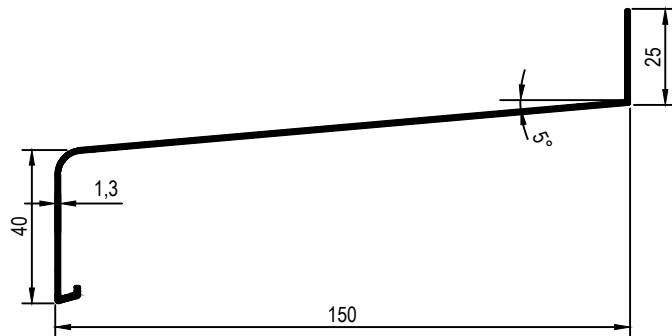

A003872

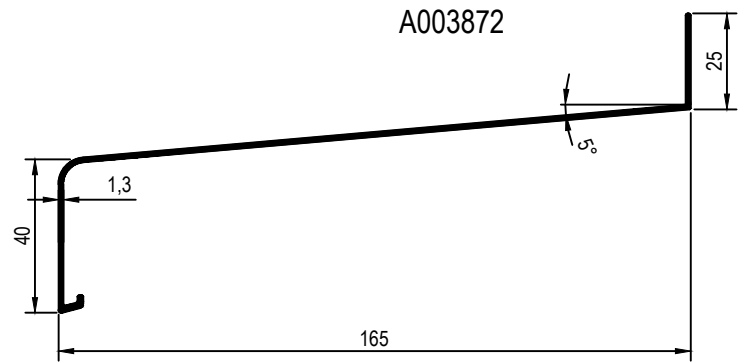

A003871

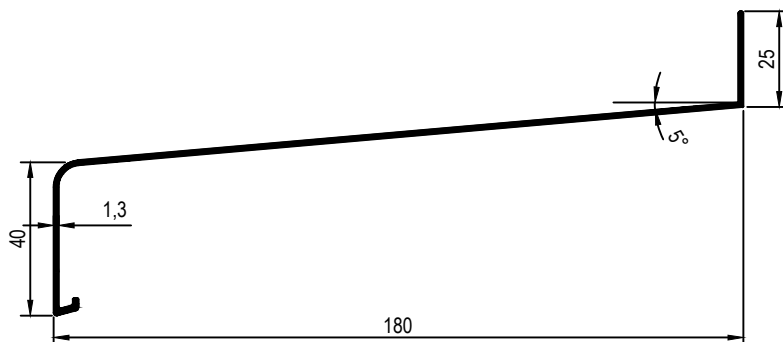

Ölçek: 1/2

DENİZLİK PROFİLLERİ

WINDOWSILL PROFILES

KOD / CODE	AĞIRLIK (kg/m) / WEIGHT	L m	KOD / CODE	AĞIRLIK (kg/m) / WEIGHT	L m
A003870	1,000	6	A003865	1,847	6
A003869	1,057	6			
A003868	1,191	6			
A003867	1,412	6			

A003870

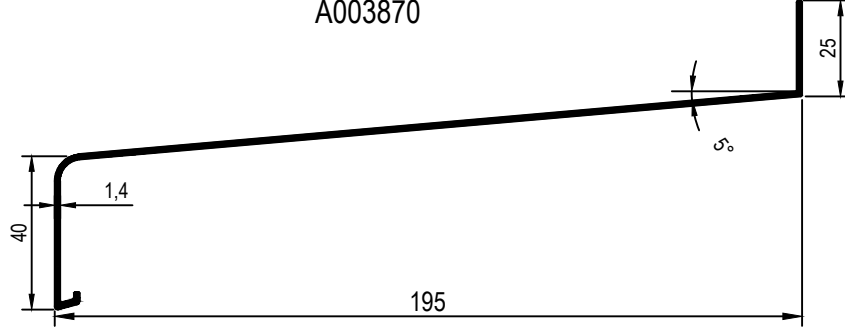

A003869

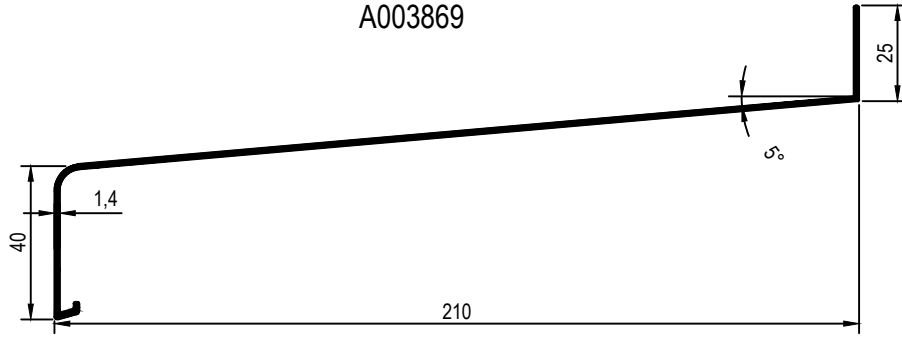

A003868

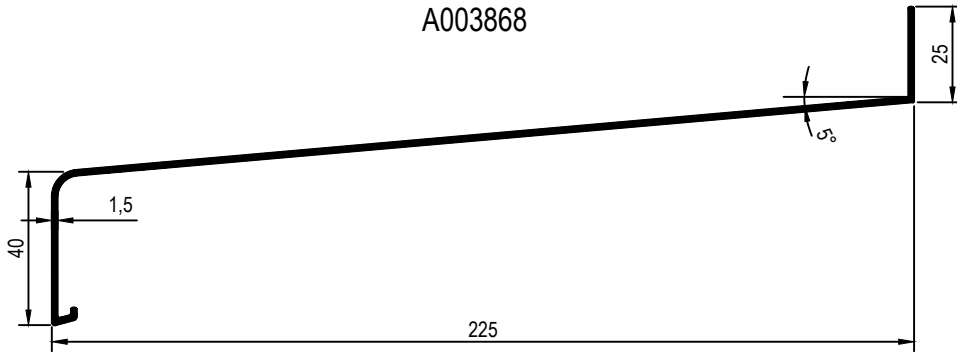

A003867

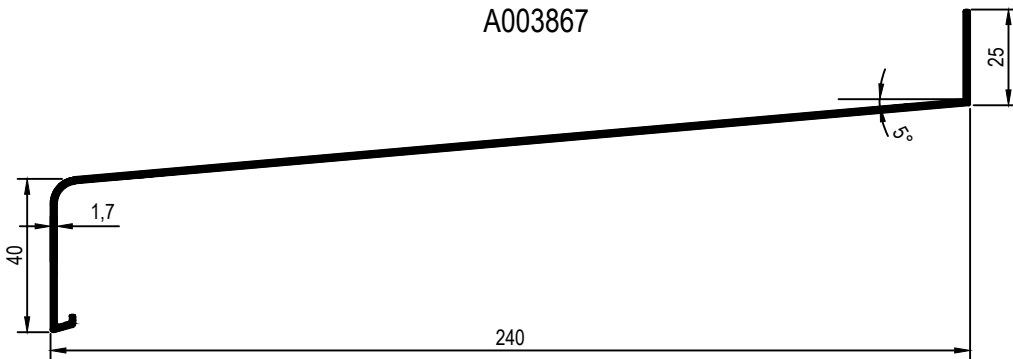

A003865

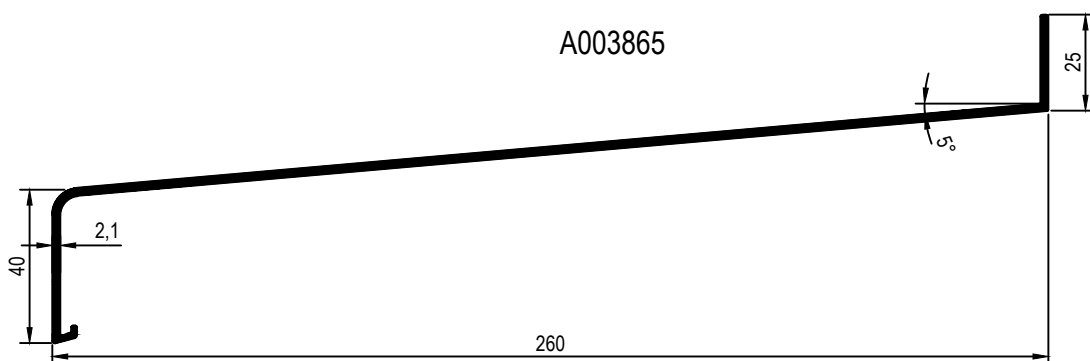

Ölçek: 1/2

DENİZLİK PROFİLLERİ

WINDOWSILL PROFILES

KOD / CODE	AĞIRLIK (kg/m) / WEIGHT	L m	KOD / CODE	AĞIRLIK (kg/m) / WEIGHT	L m
A003786	2,171	6			
A003787	2,291	6			
A003788	2,411	6			
A003789	2,642	6			

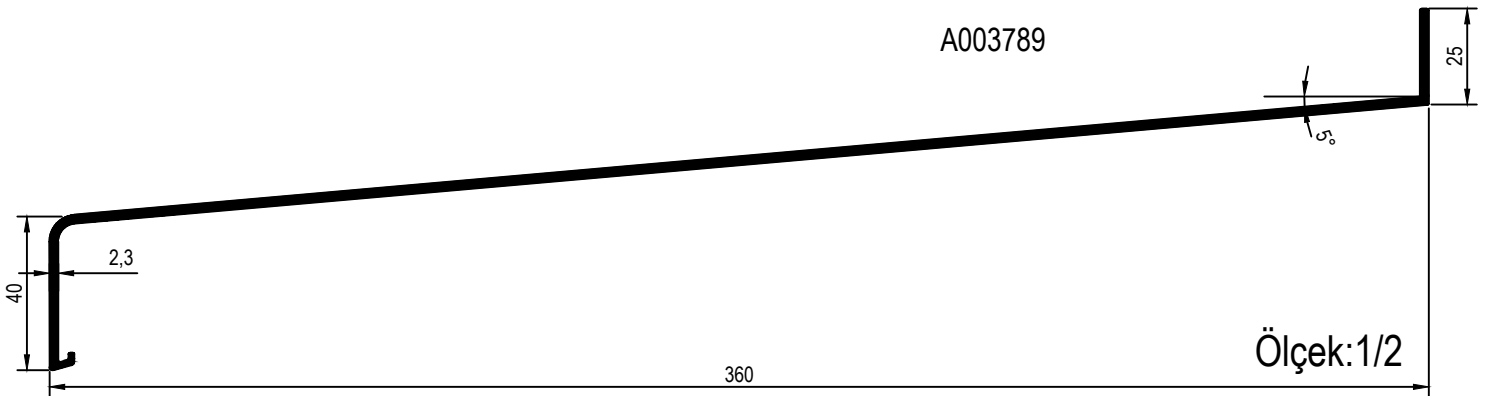
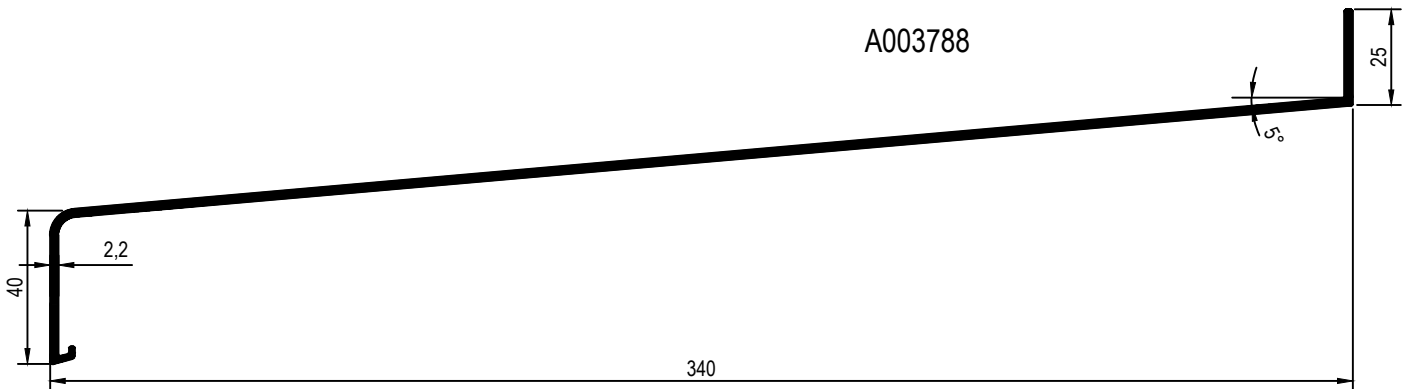
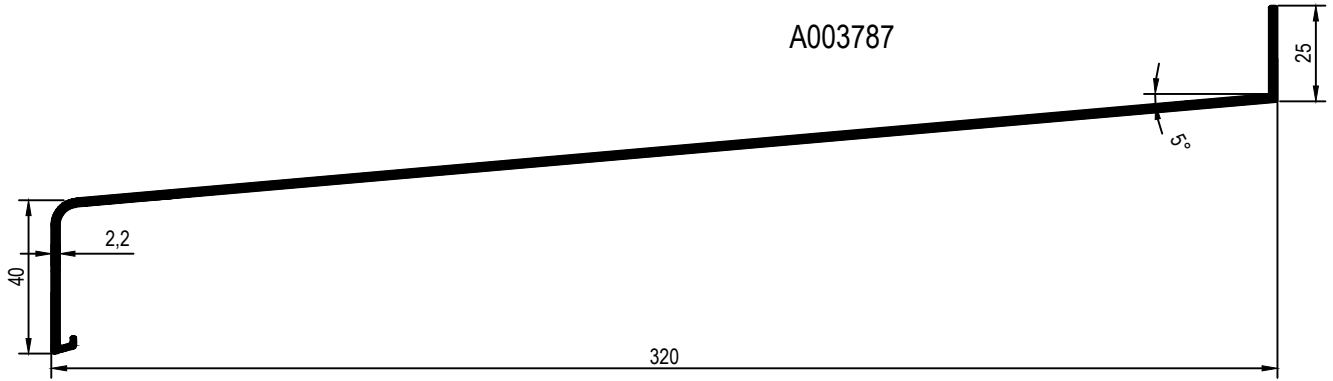
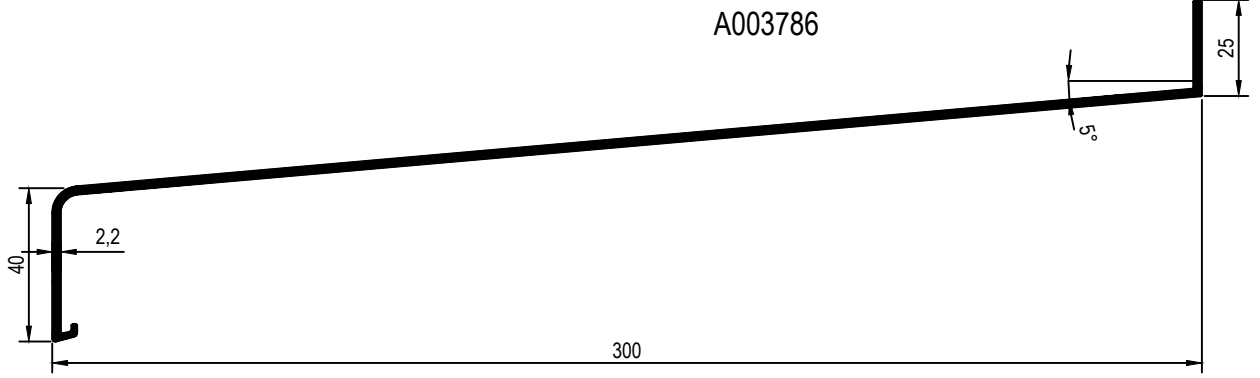

DENİZLİK PROFİLLERİ

WINDOWSILL PROFILES

KOD / CODE	AĞIRLIK (kg/m) / WEIGHT	L m	KOD / CODE	AĞIRLIK (kg/m) / WEIGHT	L m
A003866	1,870	6			
A006032	3,002	6			
A006033	3,384	6			

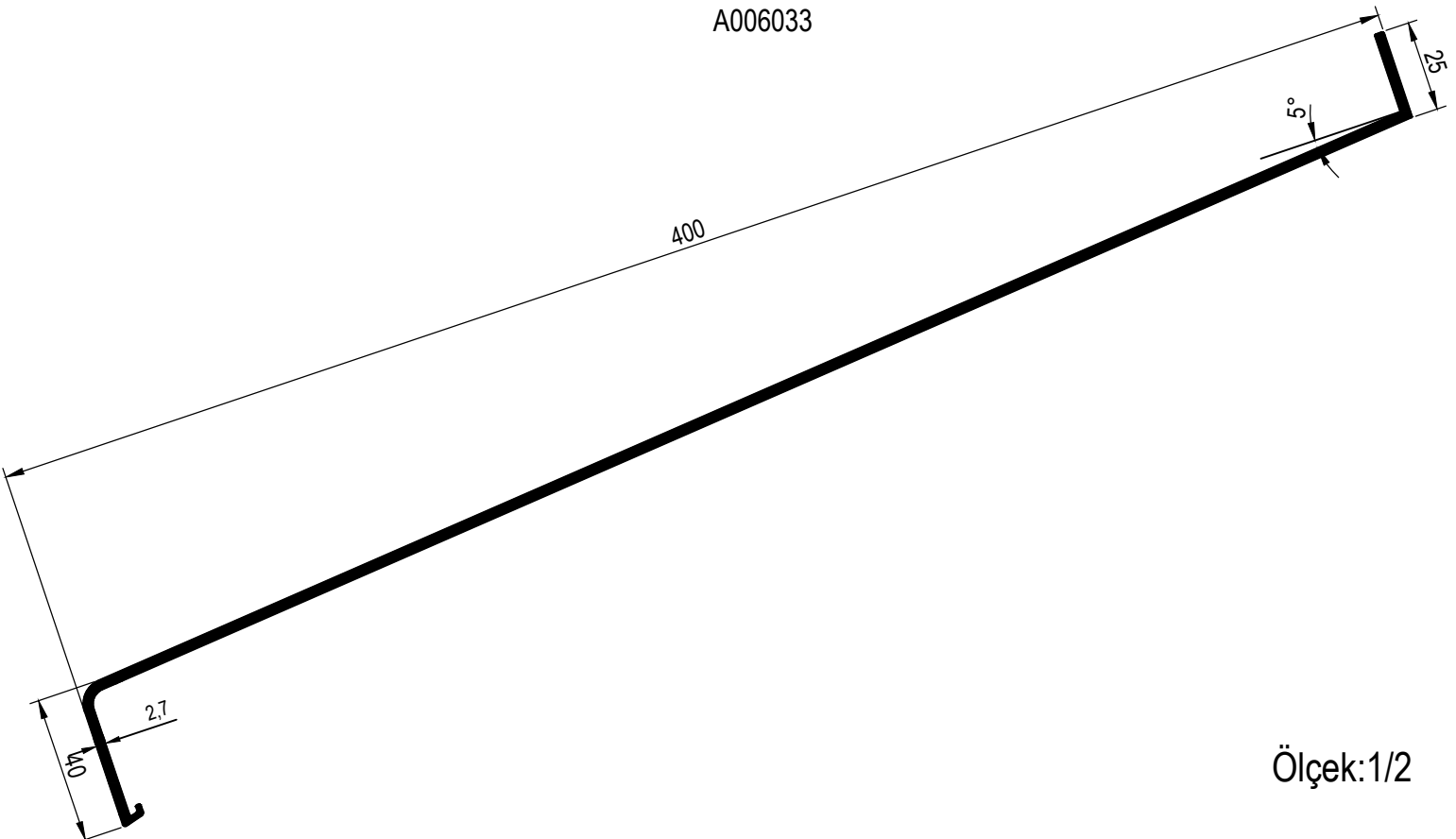
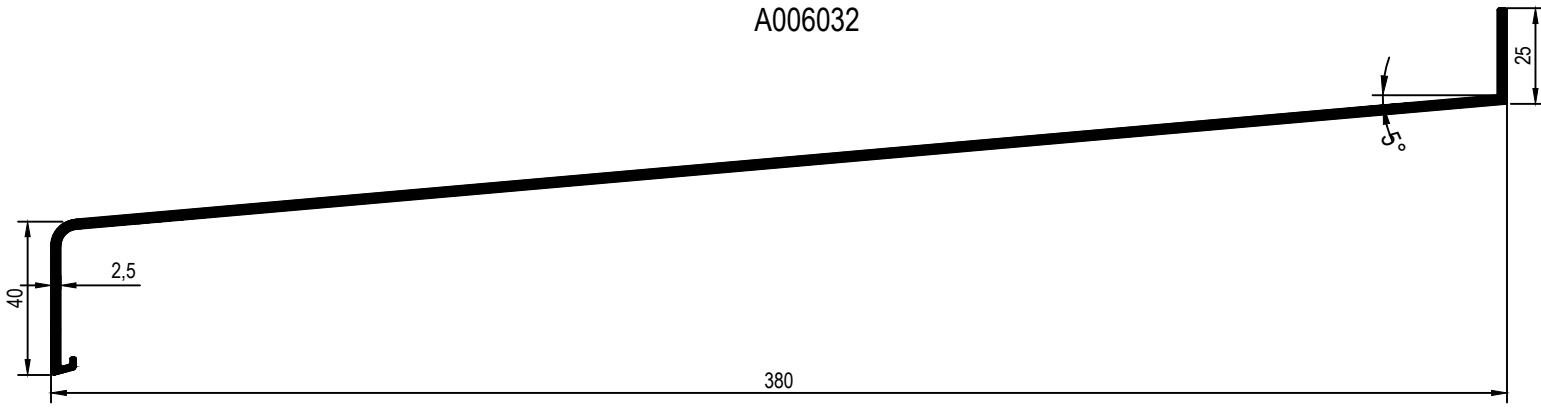
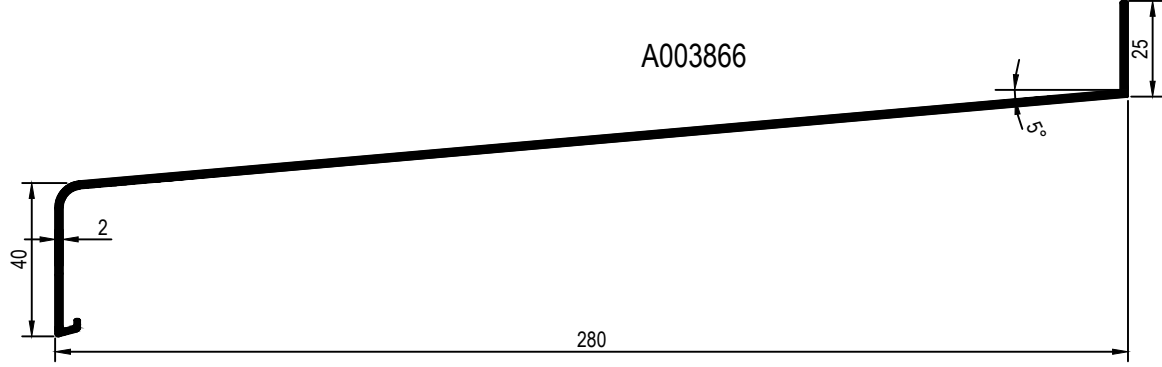

Ölçek: 1/2

DENİZLİK PROFİLLERİ

WINDOWSILL PROFILES

KOD / CODE	AĞIRLIK (kg/m) / WEIGHT	L m	KOD / CODE	AĞIRLIK (kg/m) / WEIGHT	L m
A004457	0,666		A004453	1,020	
A004456	0,737				
A004455	0,807				
A004454	0,879				

A004457

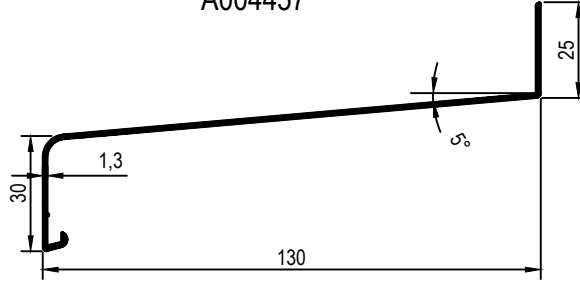

A004456

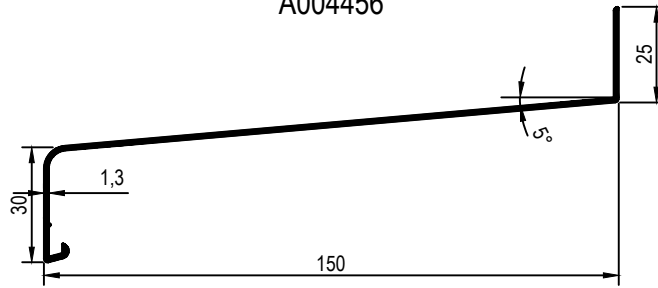

A004455

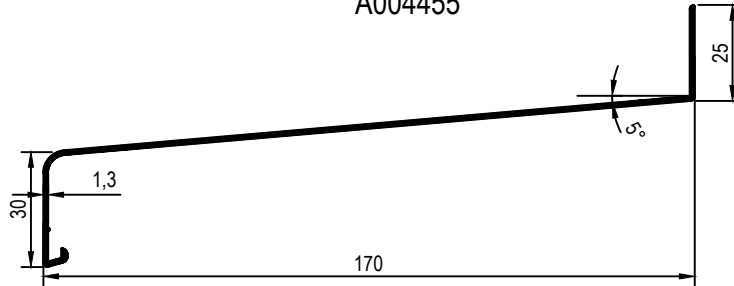

A004454

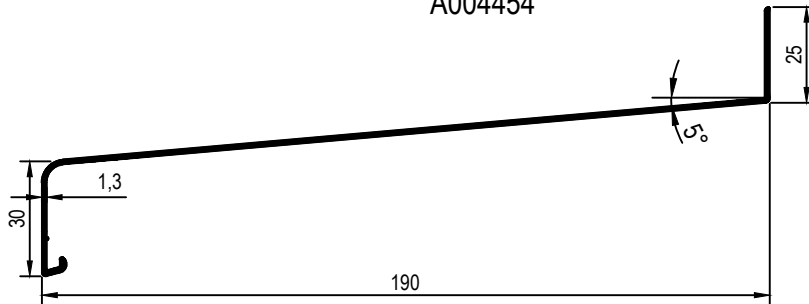

A004453

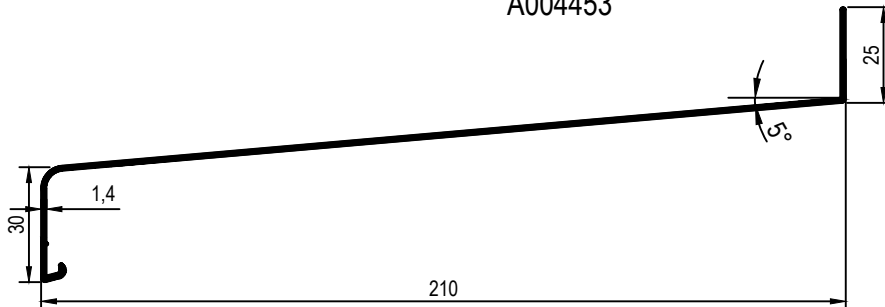

Ölçek:1/2

DENİZLİK PROFİLLERİ

WINDOWSILL PROFILES

KOD / CODE	AĞIRLIK (kg/m) / WEIGHT	L m	KOD / CODE	AĞIRLIK (kg/m) / WEIGHT	L m
A004143	0,317	6	A004138	0,720	6
A004142	0,376	6	A004137	0,773	6
A004141	0,436	6	A004136	0,826	6
A004140	0,537	6	A004135	0,943	6
A004139	0,603	6			

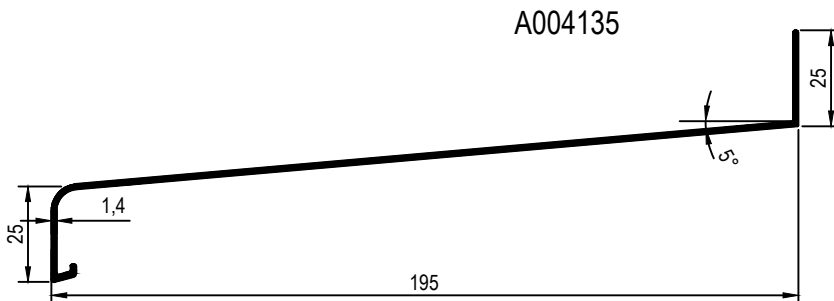
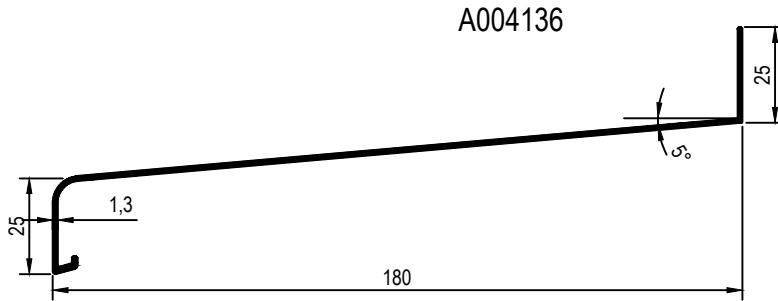
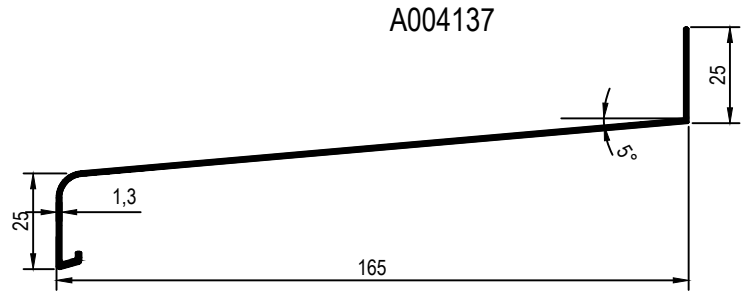
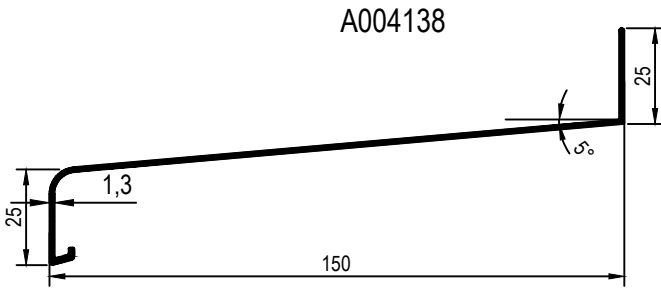
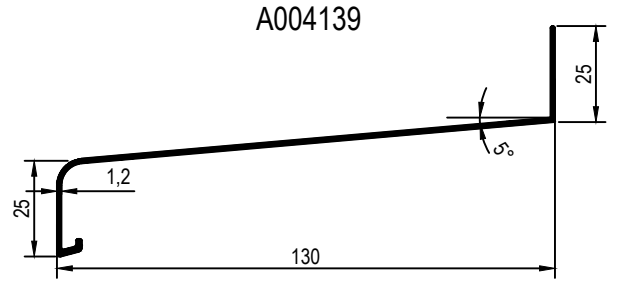
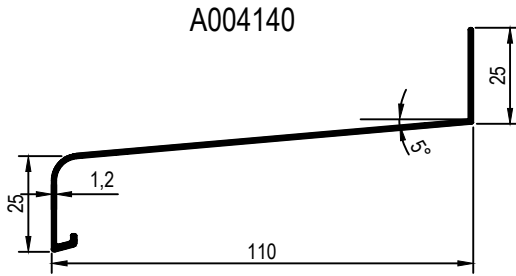
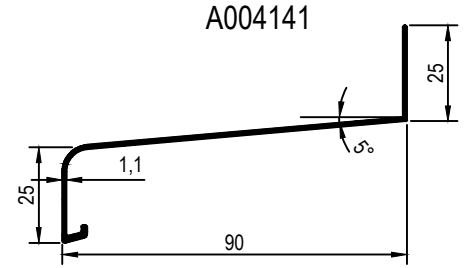
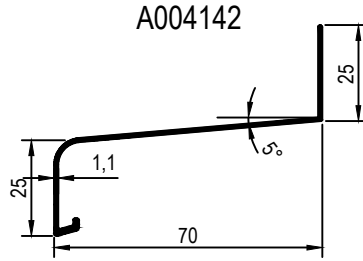
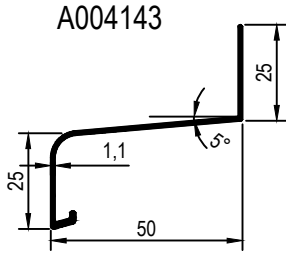

Ölçek: 1/2

DENİZLİK PROFİLLERİ

WINDOWSILL PROFILES

KOD / CODE	AĞIRLIK (kg/m) / WEIGHT	L m	KOD / CODE	AĞIRLIK (kg/m) / WEIGHT	L m
A004134	1,000	6	A004130	1,876	6
A004133	1,130	6			
A004132	1,343	6			
A004131	1,680	6			

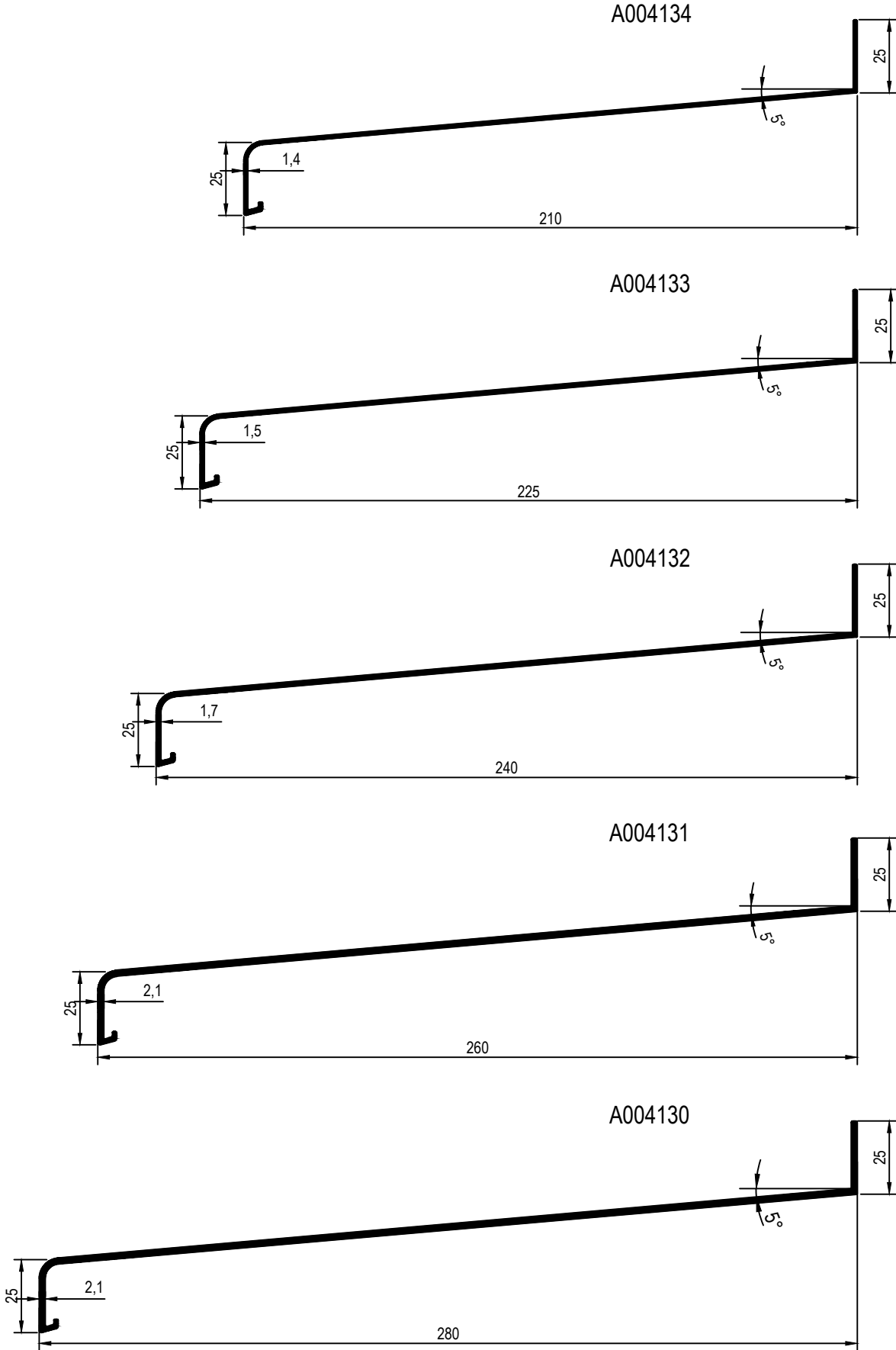

Ölçek: 1/2

DENİZLİK PROFİLLERİ

WINDOWSILL PROFILES

KOD / CODE	AĞIRLIK (kg/m) / WEIGHT	L m	KOD / CODE	AĞIRLIK (kg/m) / WEIGHT	L m
A004213	2,082	6			
A003261	2,108	6			
A004212	2,322	6			
A006085	2,549	6			

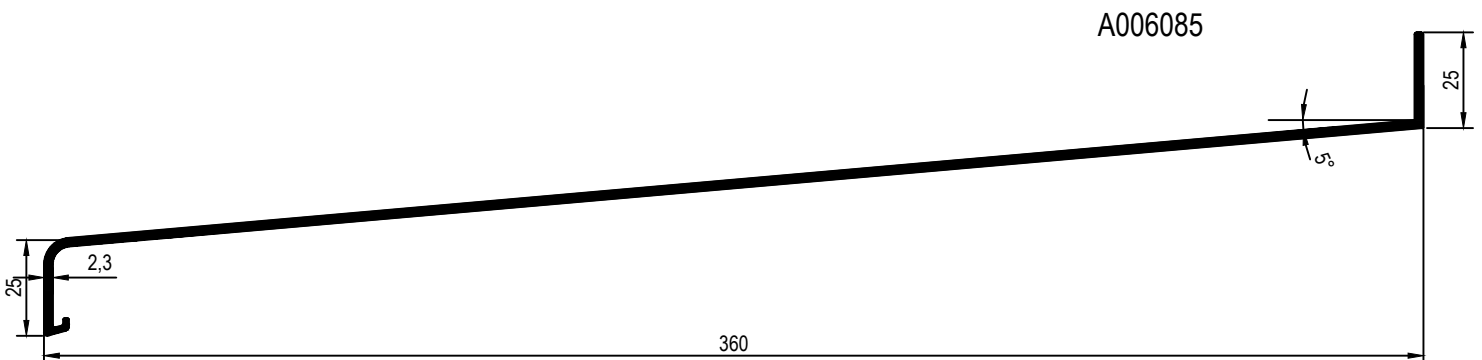
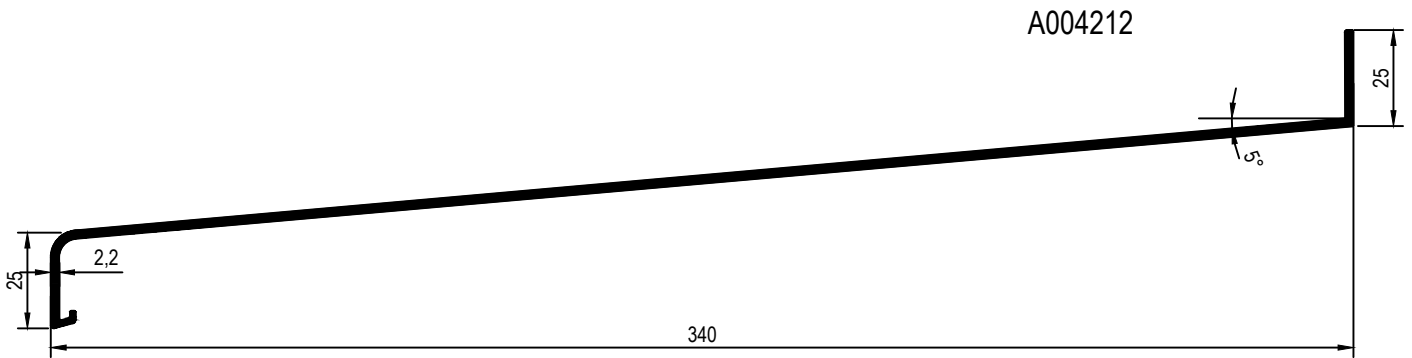
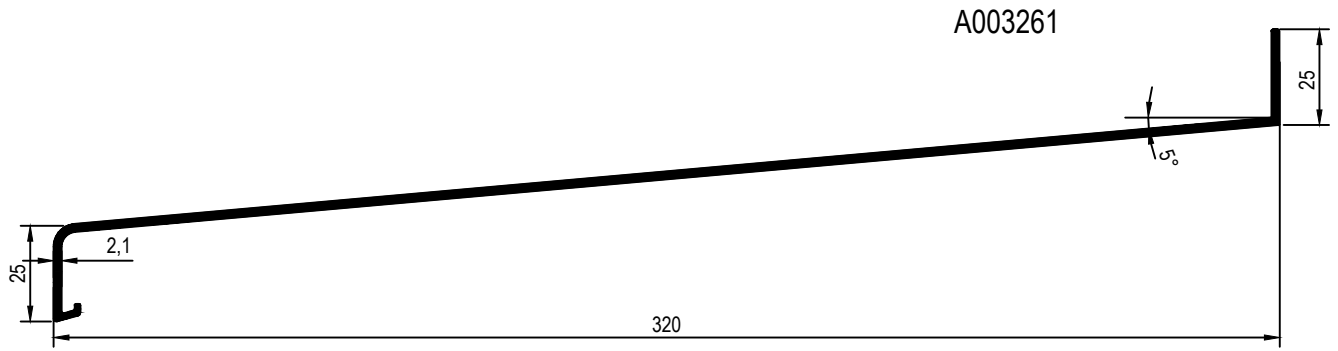
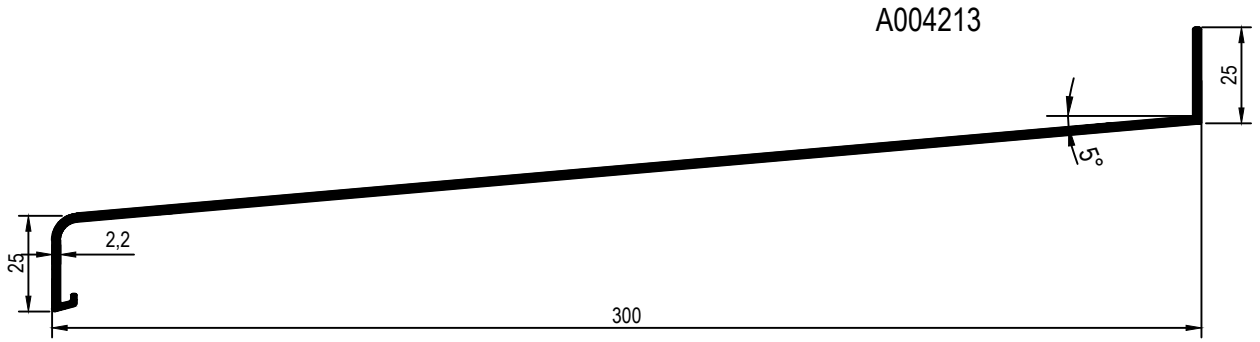

DENİZLİK PROFİLLERİ

WINDOWSILL PROFILES

KOD / CODE	AĞIRLIK (kg/m) / WEIGHT	L m	KOD / CODE	AĞIRLIK (kg/m) / WEIGHT	L m
A004527	0,709	6	A004285	1,011	6
A004513	0,780	6	A004440	1,069	6
A004514	0,834	6			
A004515	0,888	6			

A004527

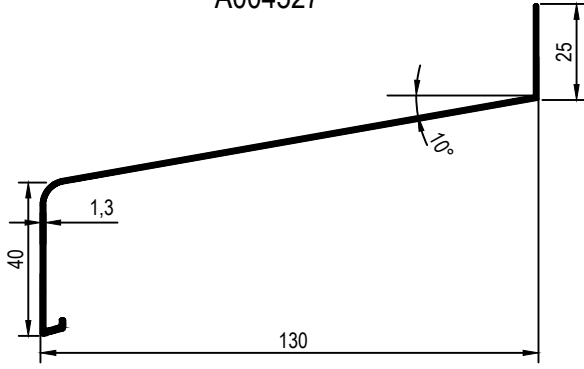

A004513

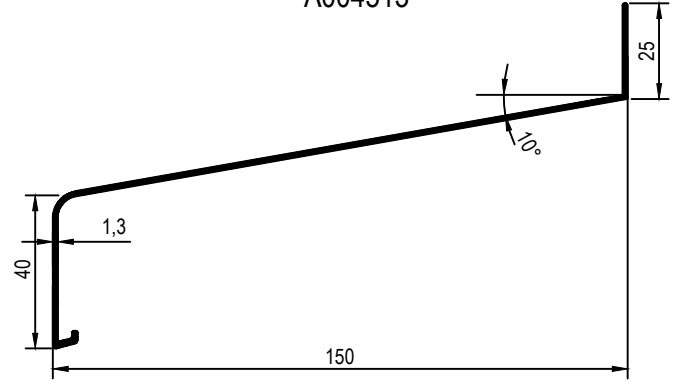

A004514

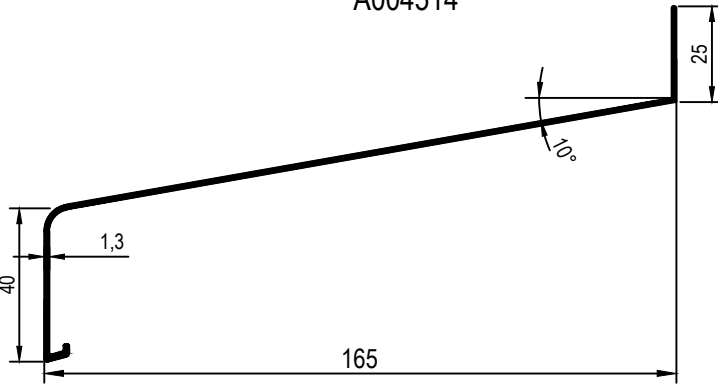

A004515

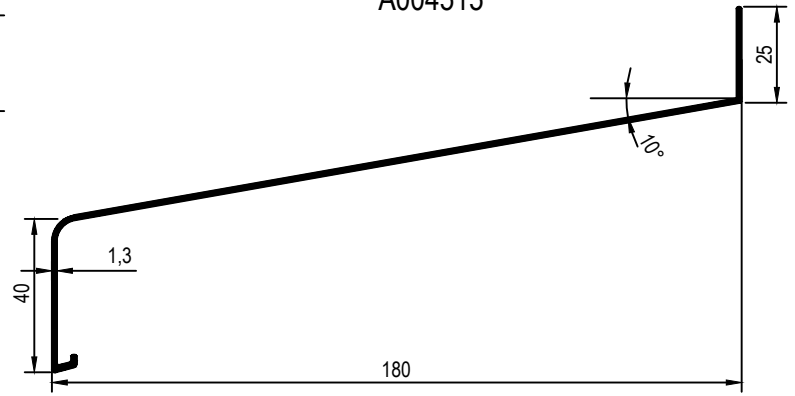

A004285

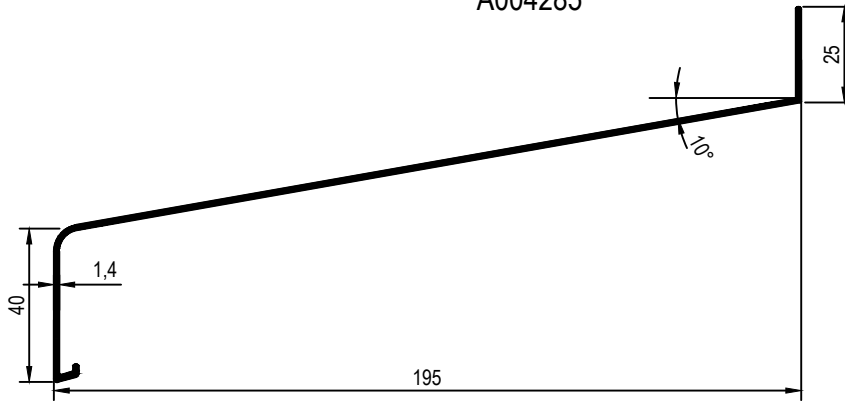

4440

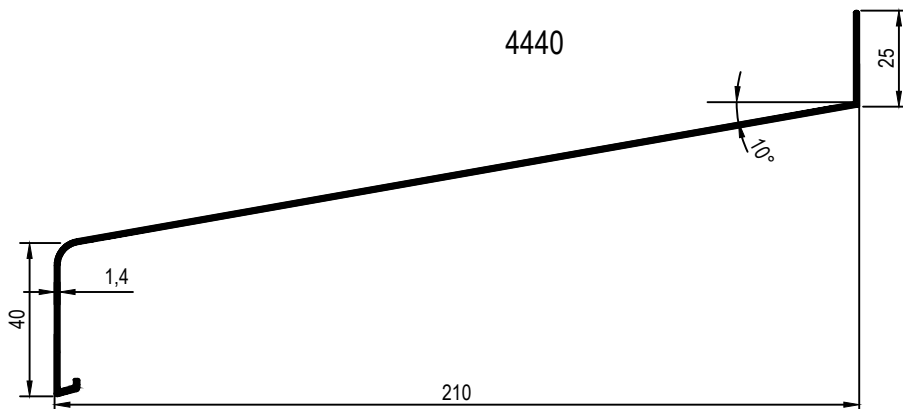

Ölçek: 1/2

DENİZLİK PROFİLLERİ

WINDOWSILL PROFILES

KOD / CODE	AĞIRLIK (kg/m) / WEIGHT	L m	KOD / CODE	AĞIRLIK (kg/m) / WEIGHT	L m
A006056	1,427	6			
A000882	0,750	6			
A000898	1,111	6			

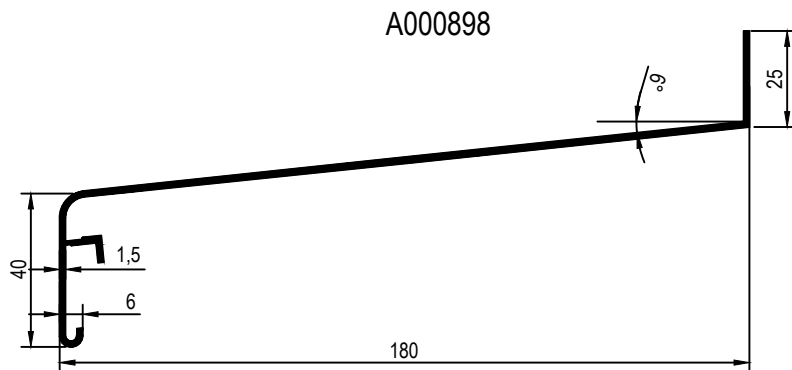
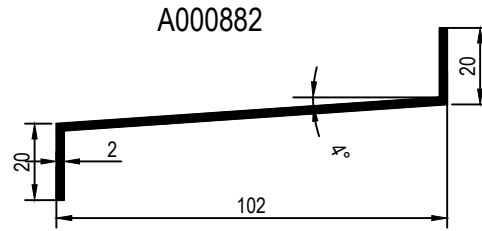
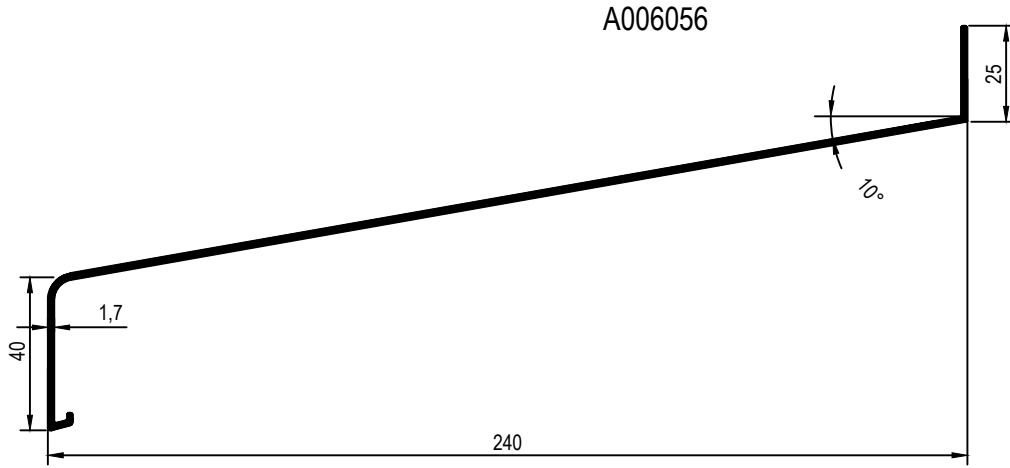

Ölçek: 1/2