

MİMARİ KATALOG
ARCHITECTURAL CATALOGUE

Alüminyum Konvansiyonel Sistemleri
Aluminium Conventional Systems

MENFEN

MENFEZ PROFİLLERİ

LOUVER PROFILES

KOD / CODE	AĞIRLIK (kg/m) / WEIGHT	L m	KOD / CODE	AĞIRLIK (kg/m) / WEIGHT	L m
A011867	0,803	6			
A011868	0,917	6			
A011888	0,460	6			
A011889	0,450	6			

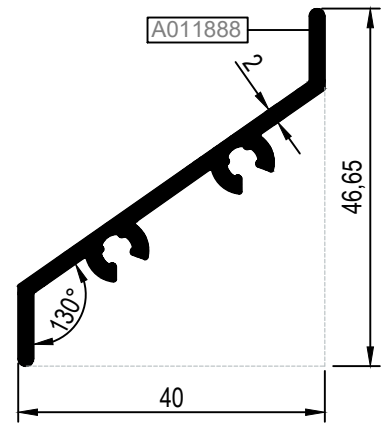
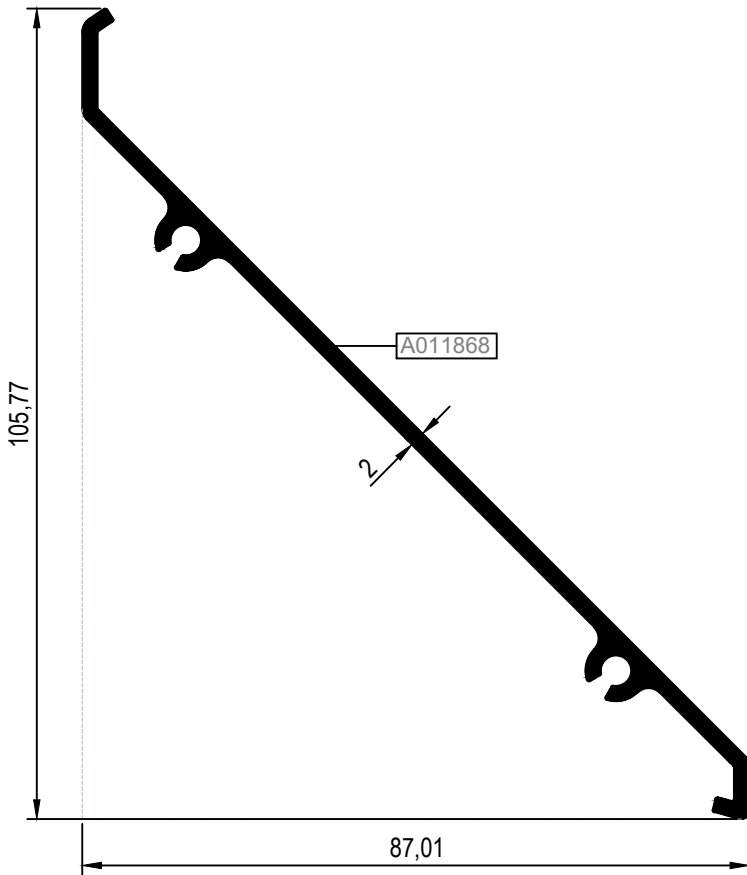
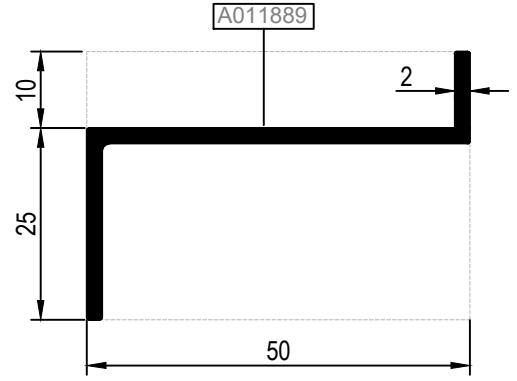
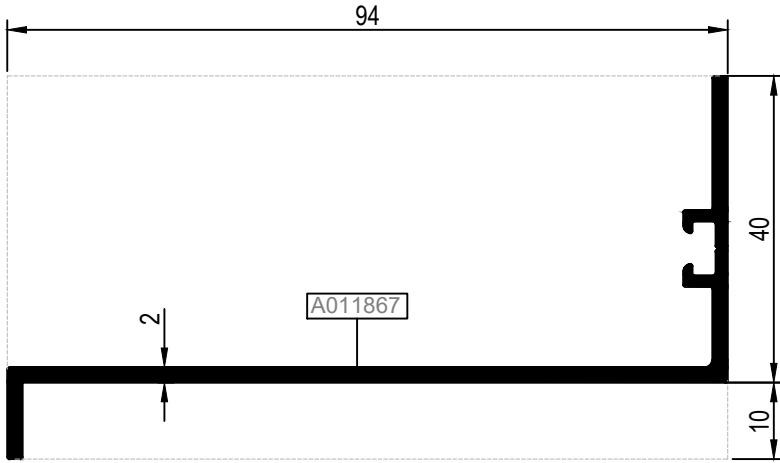

MENFEZ PROFİLLERİ

LOUVER PROFILES

KOD / CODE	AĞIRLIK (kg/m) / WEIGHT	L m	KOD / CODE	AĞIRLIK (kg/m) / WEIGHT	L m
A010980	0,268	6	A006908	0,533	6
A000158	0,201	6	A011793	0,485	6
A011794	0,297	6			

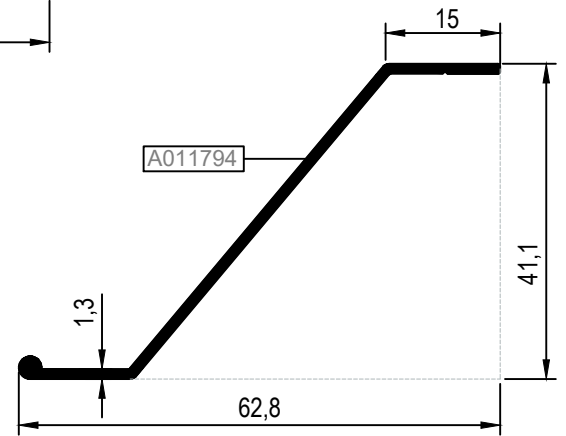
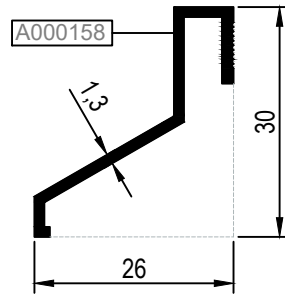
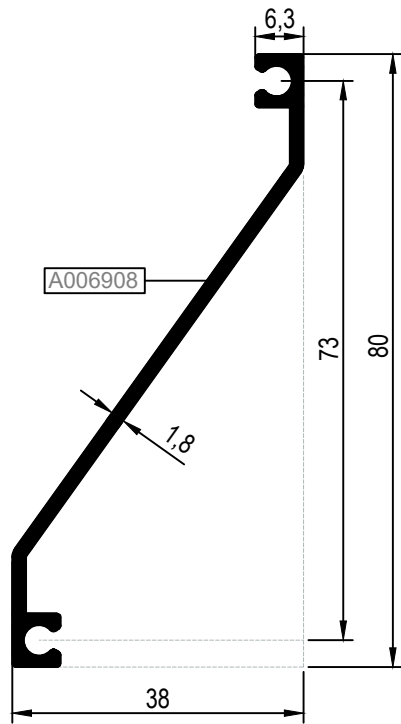
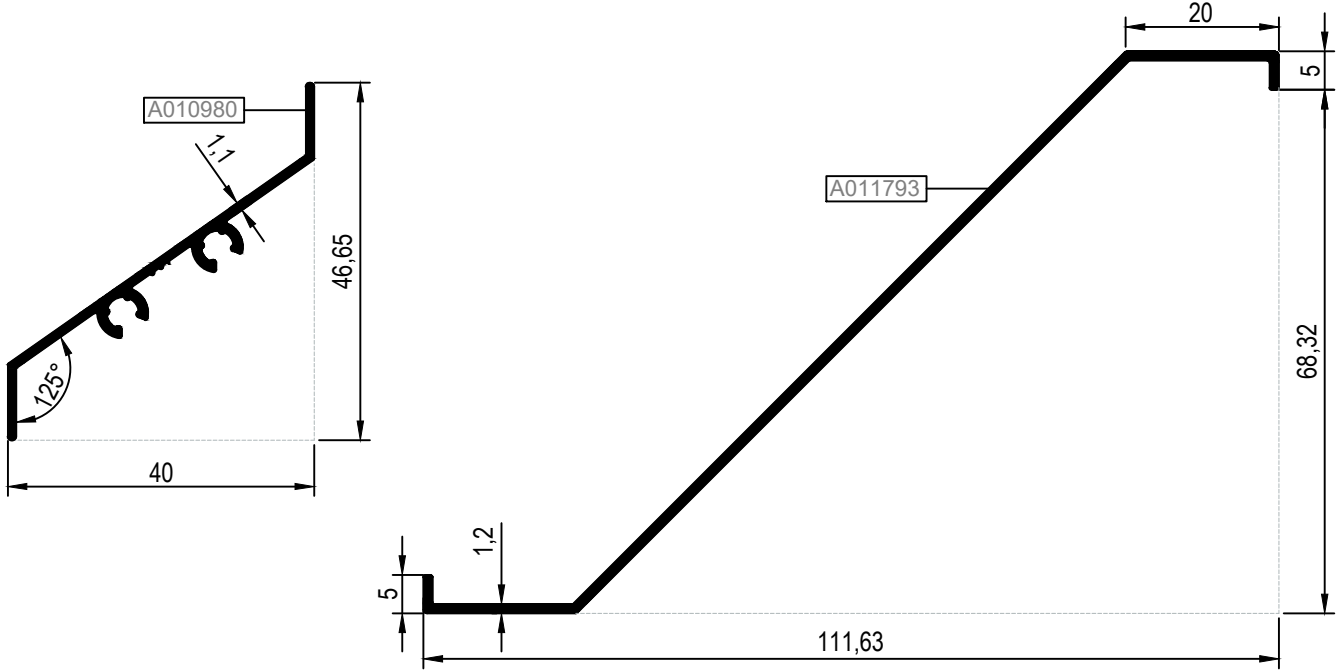

MENFEZ PROFİLLERİ

LOUVER PROFILES

KOD / CODE	AĞIRLIK (kg/m) / WEIGHT	L m	KOD / CODE	AĞIRLIK (kg/m) / WEIGHT	L m
A015259	0,399	6			
A015260	1,197	6			

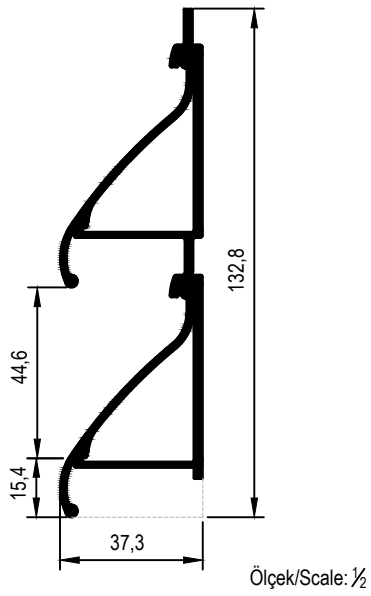
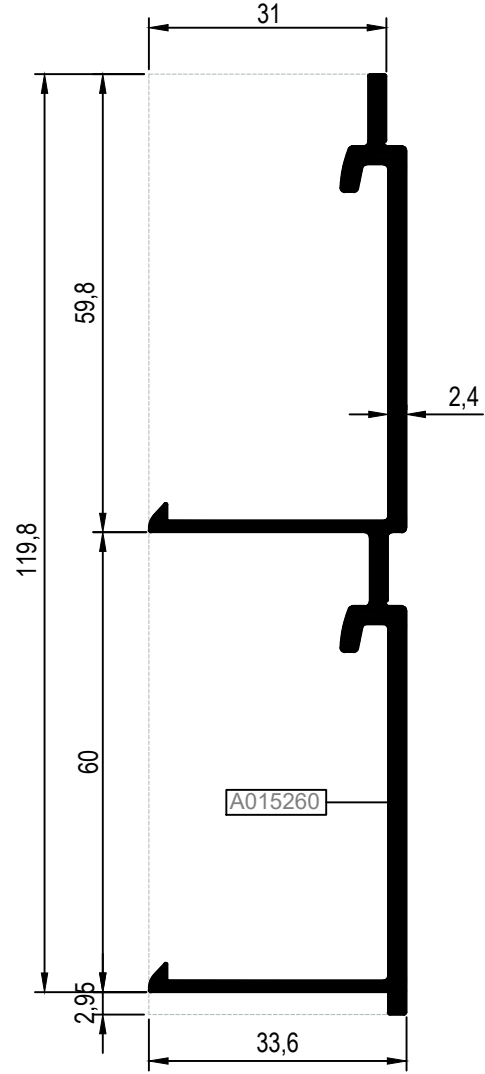
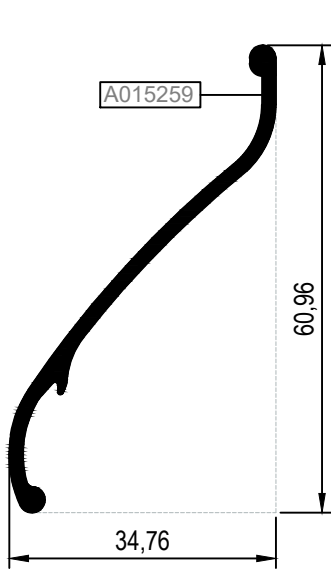

Ölçek/Scale: 1/2

MENFEZ PROFİLLERİ

LOUVER PROFILES

KOD / CODE	AĞIRLIK (kg/m) / WEIGHT	L m	KOD / CODE	AĞIRLIK (kg/m) / WEIGHT	L m
A016295	0,568	6			
A016296	0,638	6			

