

**MİMARİ KATALOG**  
ARCHITECTURAL CATALOGUE

**Alüminyum Konvansiyonel Sistemleri**  
Aluminium Conventional Systems



**DÜZ ALDOKS**

**MİMARİ KATALOG**  
ARCHITECTURAL CATALOGUE

Alüminyum Konvansiyonel Sistemleri  
Aluminium Conventional Systems

# DÜZ ALDOKS

**PROFİLLER**

PROFILES

KOD / CODE	AĞIRLIK (kg/m) / WEIGHT	L m	KOD / CODE	AĞIRLIK (kg/m) / WEIGHT	L m
A000536	0,601	6	A000182	0,703	6
A000537	0,600	6	A000183	0,608	6
A000538	0,502	6	A000181	0,704	6

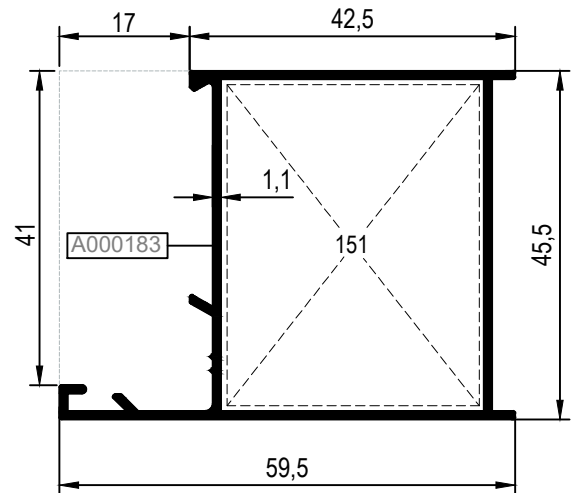
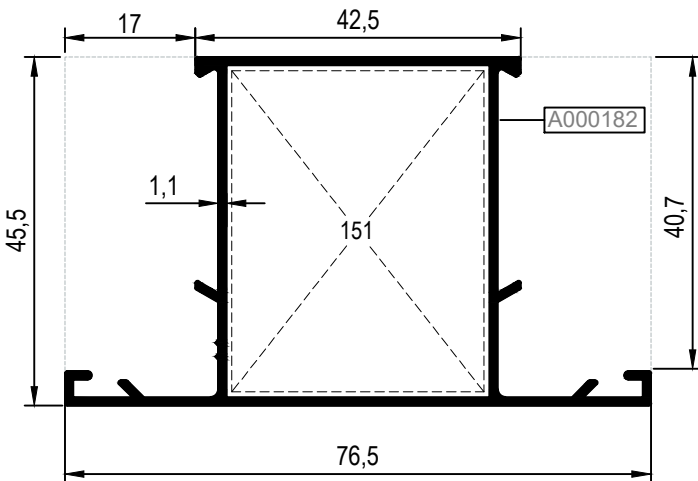
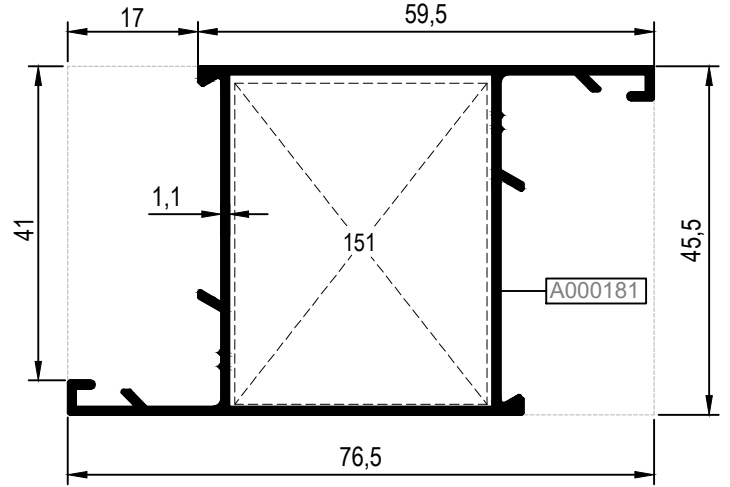
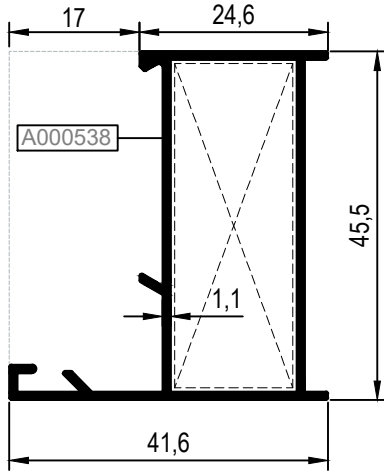
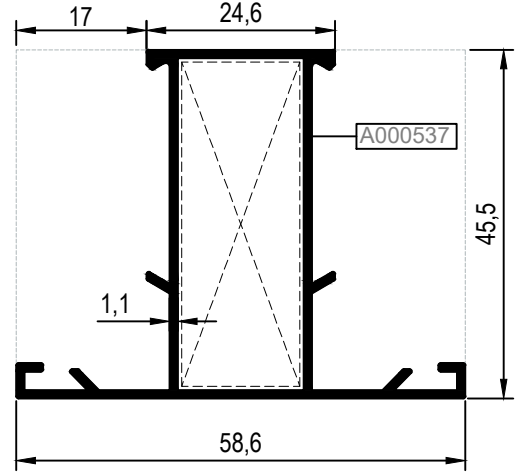
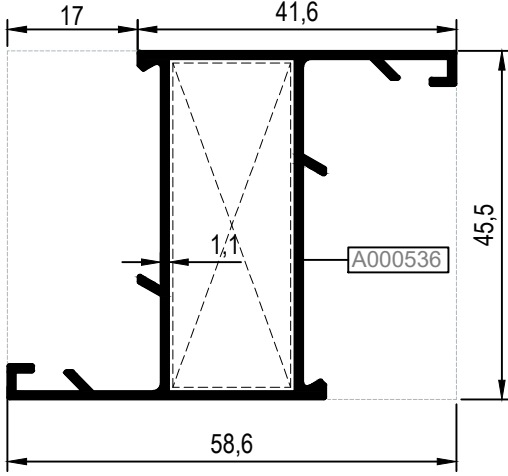
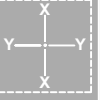

KOD / CODE	AĞIRLIK (kg/m) / WEIGHT	L m	KOD / CODE	AĞIRLIK (kg/m) / WEIGHT	L m
A003292	1,242	6			
A003293	1,135	6			
A003294	1,137	6			

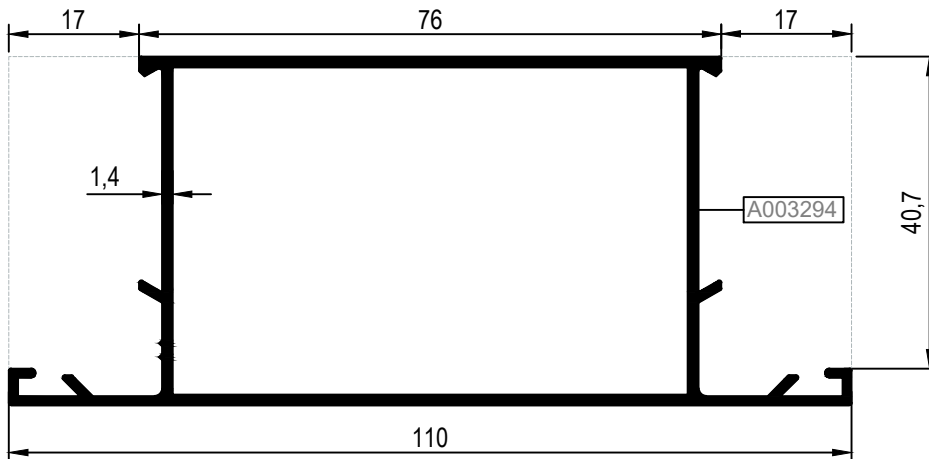
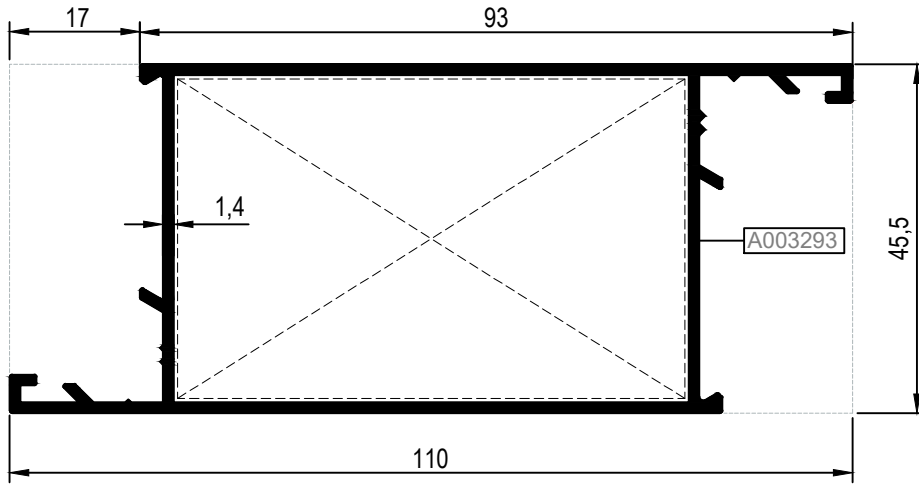
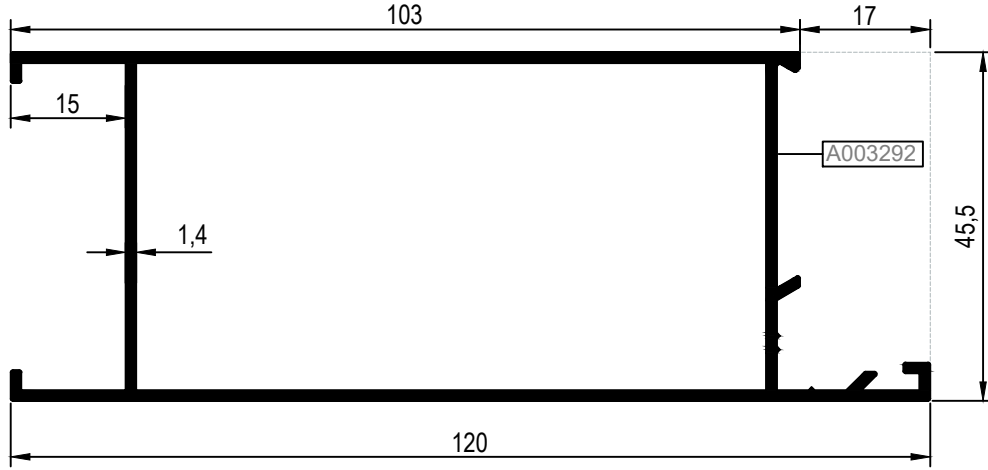
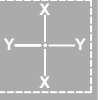

KOD / CODE	AĞIRLIK (kg/m) / WEIGHT	L m	KOD / CODE	AĞIRLIK (kg/m) / WEIGHT	L m
A000184	1,733	6			
A000185	1,876	6			

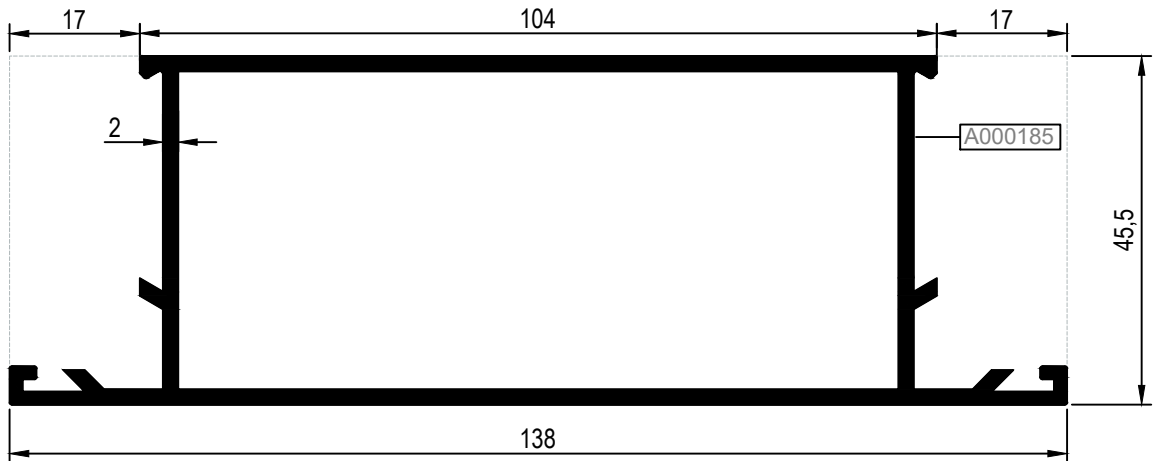
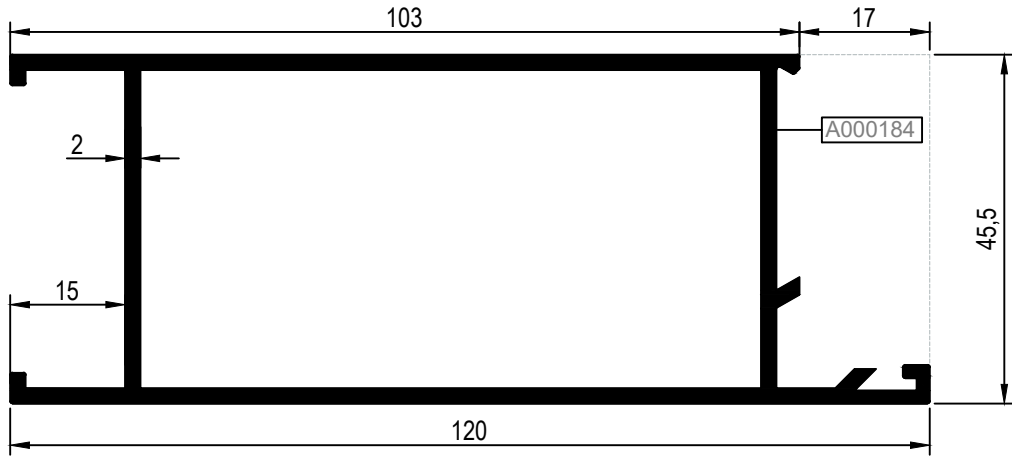
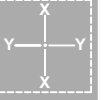

KOD / CODE	AĞIRLIK (kg/m) / WEIGHT	L m	KOD / CODE	AĞIRLIK (kg/m) / WEIGHT	L m
A000110	1,835	6			
A004306	0,786	6			
A011190	0,848	6			

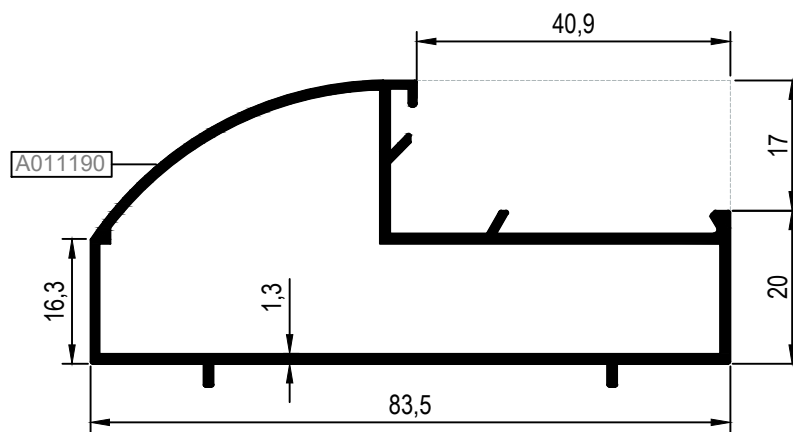
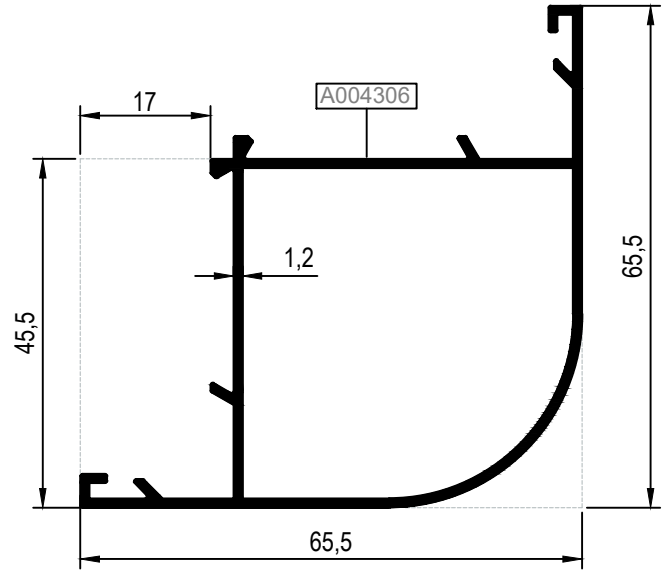
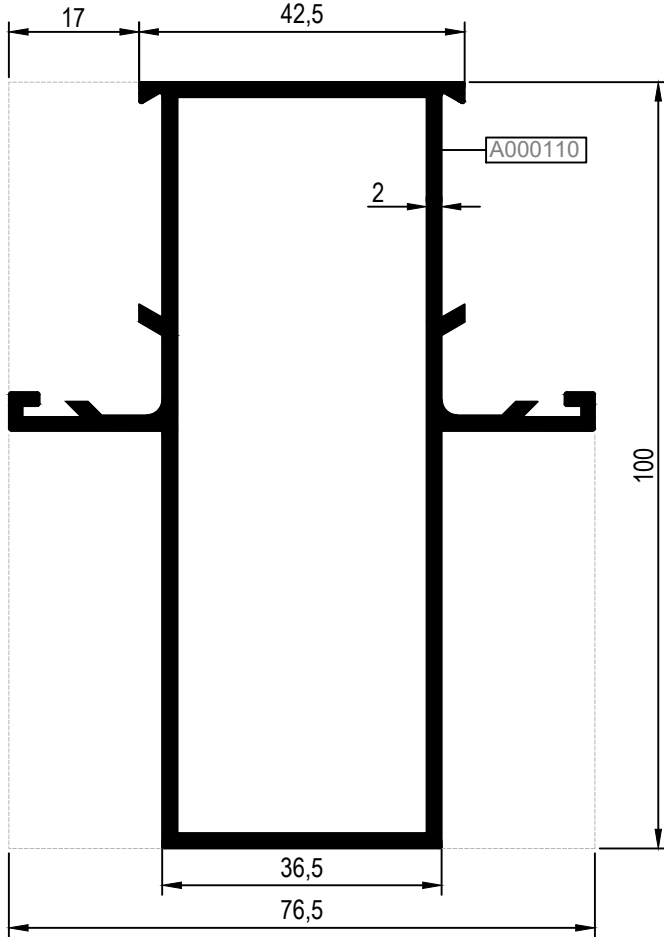
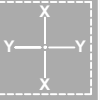

KOD / CODE	AĞIRLIK (kg/m) / WEIGHT	L m	KOD / CODE	AĞIRLIK (kg/m) / WEIGHT	L m
A000151	1,157	6			
A000152	0,890	6			
A000154	0,593	6			

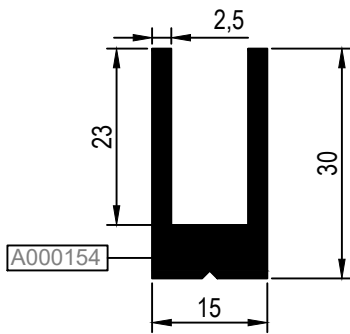
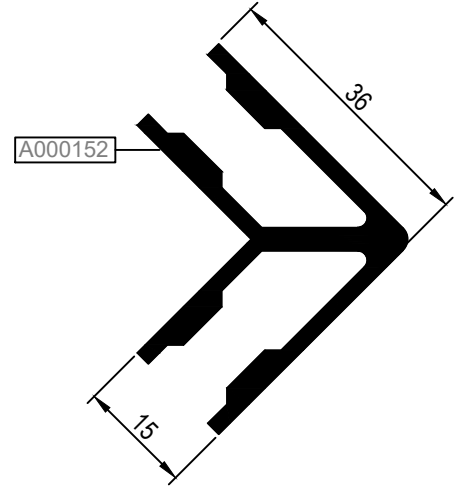
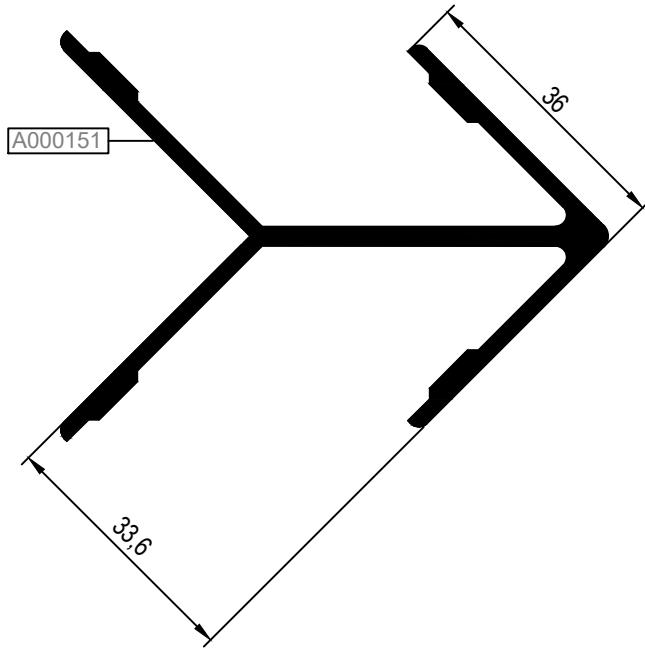
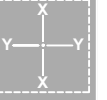

KOD / CODE	AĞIRLIK (kg/m) / WEIGHT	L m	KOD / CODE	AĞIRLIK (kg/m) / WEIGHT	L m
A000114	0,354	6	A000104	0,228	6
A000115	0,580	6	A000640	0,125	6
A000105	0,230	6	A000639	0,136	6

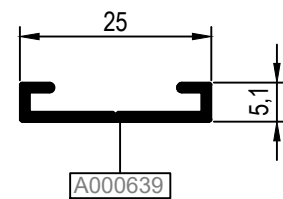
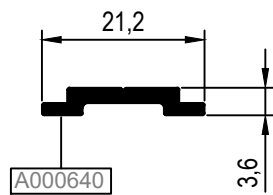
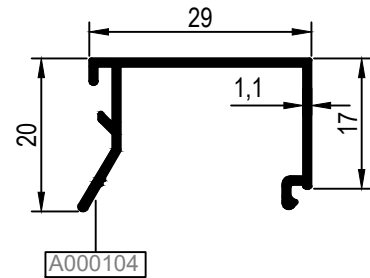
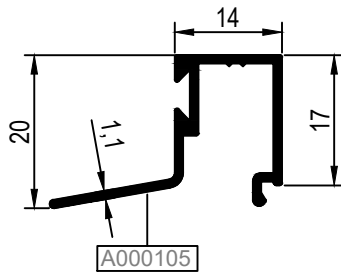
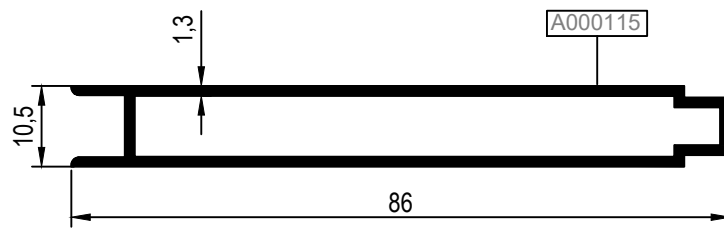
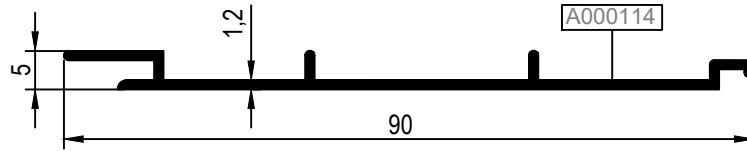
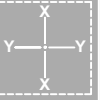

KOD / CODE	AĞIRLIK (kg/m) / WEIGHT	L m	KOD / CODE	AĞIRLIK (kg/m) / WEIGHT	L m
A000752	0,280	6	A002447	0,157	6
A002729	0,363	6	A002438	0,140	6
A002018	0,271	6	A000153	0,242	6
A002420	0,355	6	A000572	0,186	6
A002444	0,179	6	A000468	0,269	6
A000458	0,496	6			

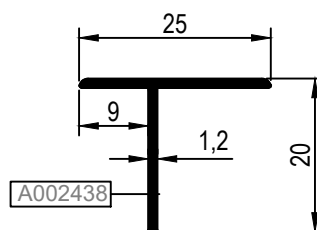
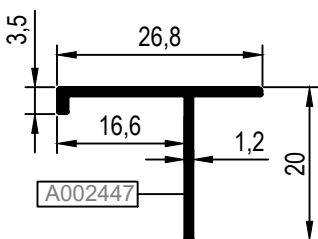
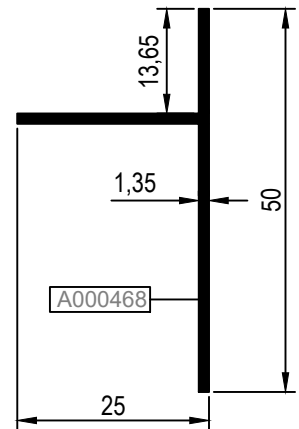
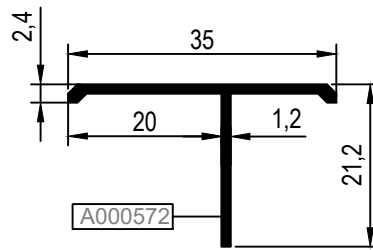
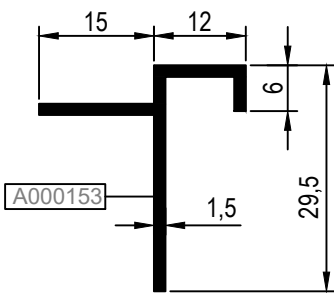
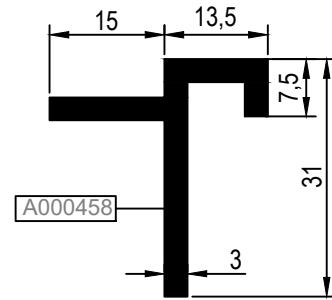
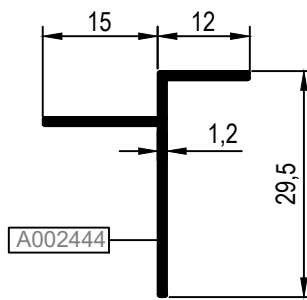
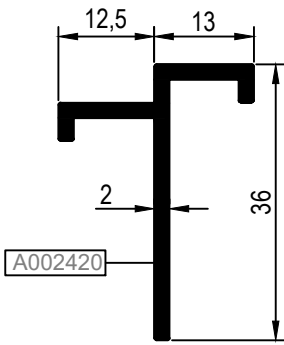
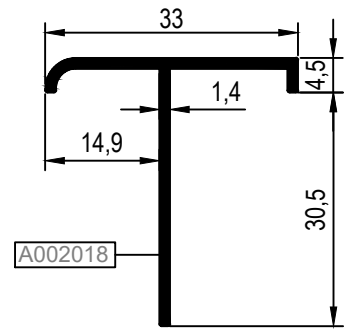
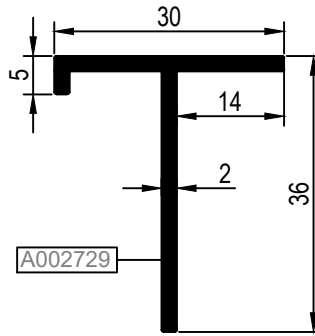
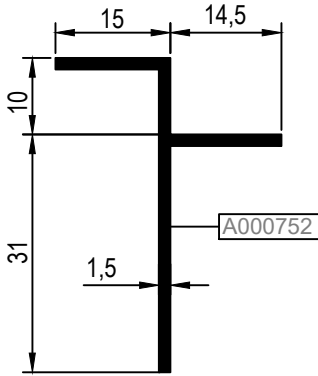
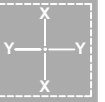











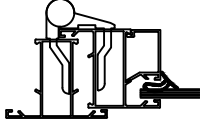

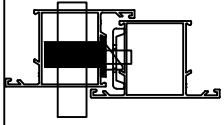

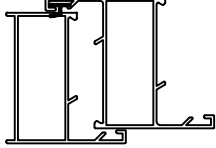
**MİMARİ KATALOG**  
**ARCHITECTURAL CATALOGUE**

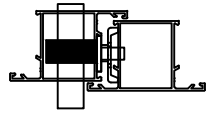
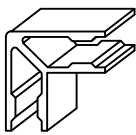
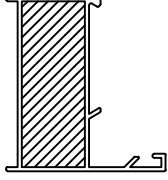
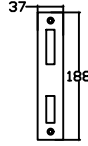
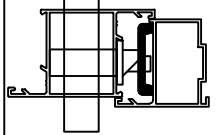
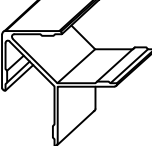
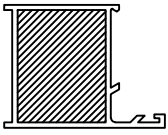

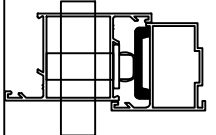
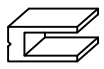
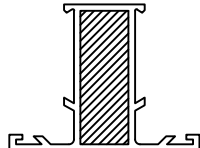
**Alüminyum Konvansiyonel Sistemleri**  
Aluminium Conventional Systems

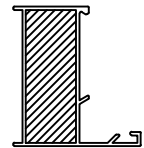
# DÜZ ALDOKS

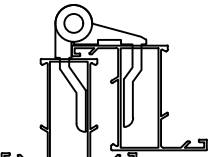
**AKSESUARLAR**

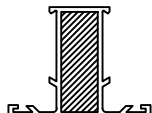
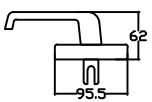
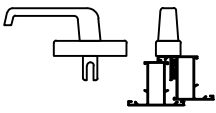
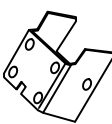
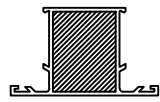
**ACCESSORIES**

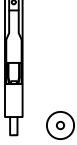
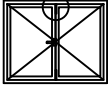
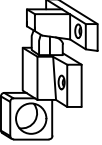
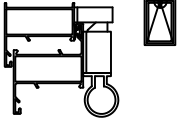
	<p><b>01.17.13</b></p> <p>CAM FİTİLİ GLAZING GASKET</p> <p>Malzeme / Material: EPDM Ağırlık / Weight: 17 gr/m Paket / Package: 202 m / 15 kg</p>			<p><b>18.01.04</b></p> <p>DİLLİ KİLİT</p>	
	<p><b>01.18.26</b></p> <p>KANAT FİTİLİ WING GASKET</p> <p>Malzeme / Material: EPDM Ağırlık / Weight: 0.025 kg/m Paket / Package: -</p>			<p><b>18.01.05</b></p> <p>MAKARALI KİLİT</p>	
	<p><b>114 L 65</b></p> <p>ALDOKS DAR KASA KANAT ORT.KAYIT KÖŞE TAKOZU</p> <p>Malzeme / Material: Alüminyum</p>			<p><b>18.02.15</b></p> <p>DİLLİ KİLİT KARŞILIĞI</p>	
	<p><b>114 L 66</b></p> <p>ALDOKS GENİŞ KASA KANAT ORT.KAYIT KÖŞE TAKOZU</p> <p>Malzeme / Material: Alüminyum</p>			<p><b>18.02.16</b></p> <p>MAKARALI KİLİT KARŞILIĞI</p>	
	<p><b>114 J 14</b></p> <p>ALDOKS DAR ORT.KAYIT BAĞLANTISI</p> <p>Malzeme / Material: Alüminyum</p>			<p><b>10.08.01</b></p> <p>KÖŞE TAKOZU</p>	
	<p><b>15.01.10</b></p> <p>DÜZ ALDOKS MENTEŞE</p> <p>Malzeme / Material: Alüminyum</p>			<p><b>10.08.02</b></p> <p>ALDOKS DAR ORTA KAYIT BAĞLANTISI</p>	
	<p><b>07.05.21N</b></p> <p>EKSENEL KOL</p>			<p><b>10.08.03</b></p> <p>ALDOKS GENİŞ ORTA KAYIT BAĞLANTISI</p>	

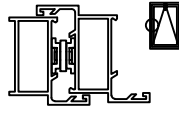
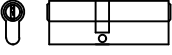
	<p>18.03.01</p> <p>ALDOKS SÜRGÜ</p>				
	<p>07.08.03</p> <p>VASISTAS MANDAL</p>				
	<p>07.07.06</p> <p>VASISTAS MAKAS</p>				
	<p>18.04.03</p> <p>BAREL</p>	