

MİMARİ KATALOG
ARCHITECTURAL CATALOGUE

Alüminyum Konvansiyonel Sistemler
Aluminium Conventional Systems

RSP22

MİMARİ KATALOG
ARCHITECTURAL CATALOGUE

Alüminyum Konvansiyonel Sistemler
Aluminium Conventional Systems

RSP22

PROFİLLER

PROFILES

KOD / CODE	AĞIRLIK (kg/m) / WEIGHT	L m	KOD / CODE	AĞIRLIK (kg/m) / WEIGHT	L m
SP22T01	1,255	6			
SP22T02	1,211	6			
SP22T03	1,129	6			



SP22T01

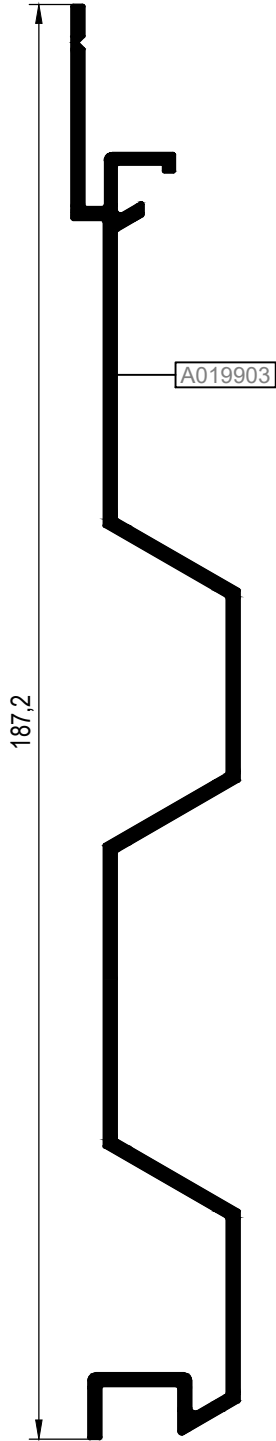

SP22T02

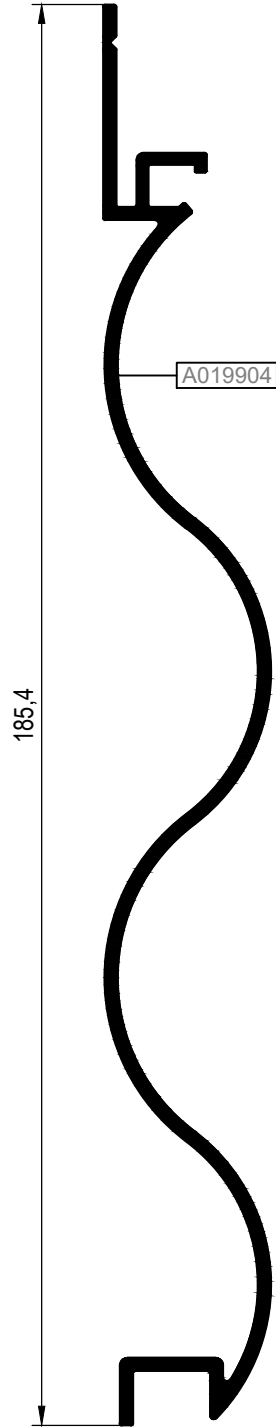

SP22T03

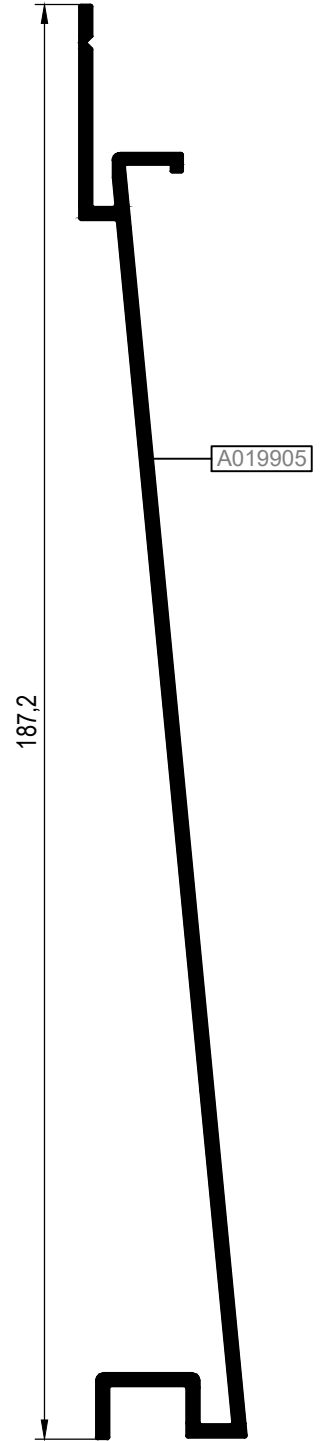

KOD / CODE	AĞIRLIK (kg/m) / WEIGHT	L m	KOD / CODE	AĞIRLIK (kg/m) / WEIGHT	L m
SP22T04	1,691	6			
SP22T05	1,840	6			



SP22T04

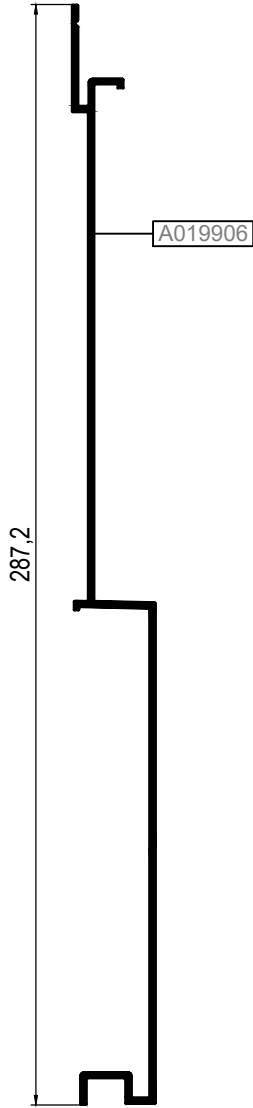

ÖLÇEK/SCALE: 1/2

SP22T05

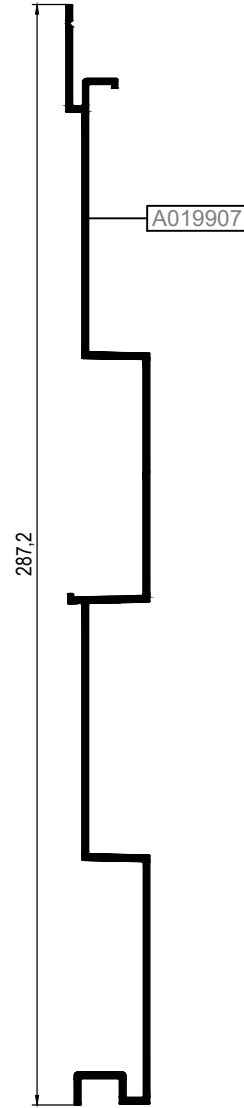

ÖLÇEK/SCALE: 1/2

KOD / CODE	AĞIRLIK (kg/m) / WEIGHT	L m	KOD / CODE	AĞIRLIK (kg/m) / WEIGHT	L m
SP22A01	0,387	6	TC22M11	0,477	
SP22A02	1,146	6	TC22M12	0,385	
SP22A03	0,386	6	TC22M13	0,382	
SP22A04	0,343	6			

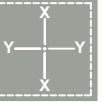

SP22A01

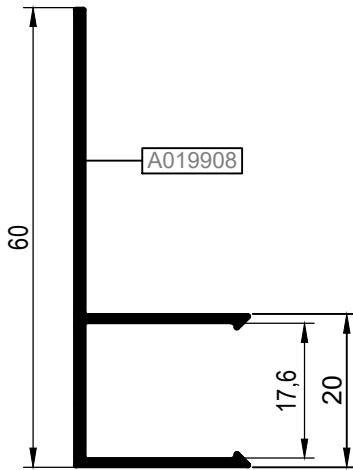

SP22A02

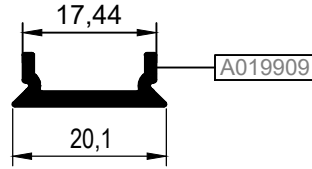

SP22A03

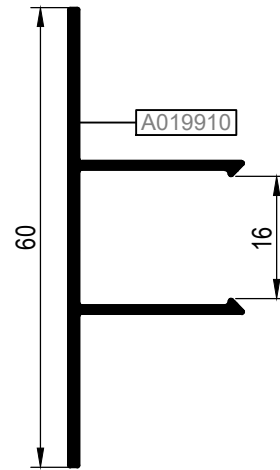

TC22M11

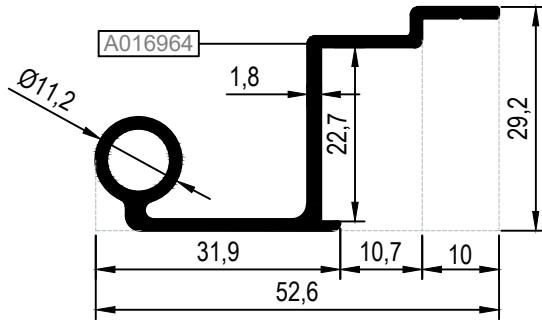

TC22M12

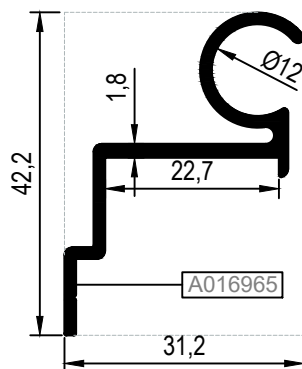

TC22M13

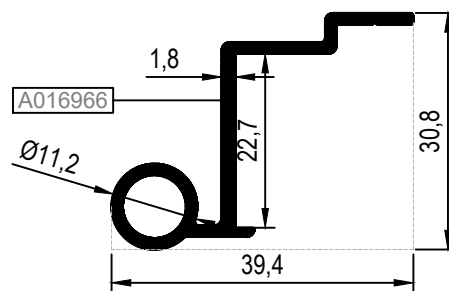

KOD / CODE	AĞIRLIK (kg/m) / WEIGHT	L m	KOD / CODE	AĞIRLIK (kg/m) / WEIGHT	L m
SP22A05	0,221	6	SP22A09	0,277	6
SP22A06	0,108	6	SP22A10	0,397	6
SP22A07	1,021	6	SP22A11	0,730	6
SP22A08	0,343	6	SP22A04	0,343	6

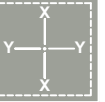

SP22A05

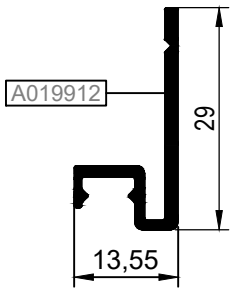

SP22A06

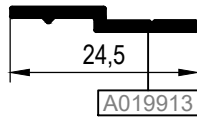

SP22A07

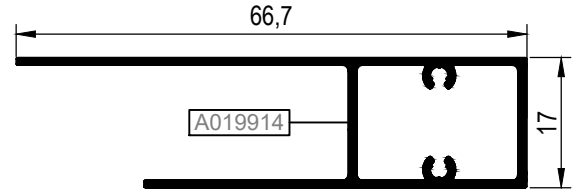

SP22A08

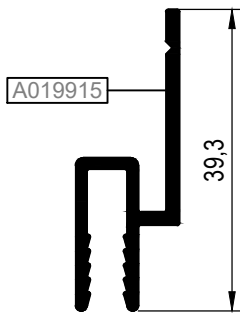

SP22A09

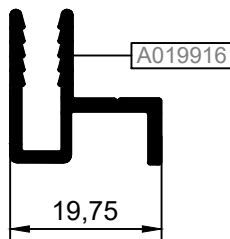

SP22A10

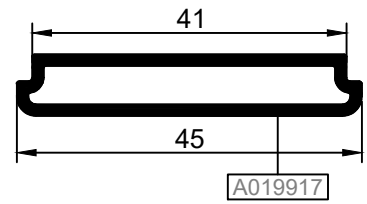

SP22A04

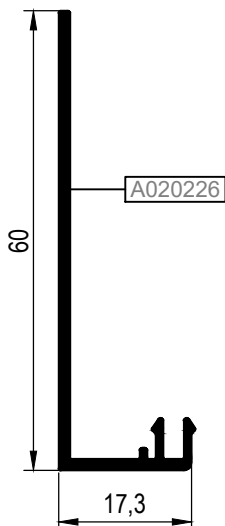

SP22A11

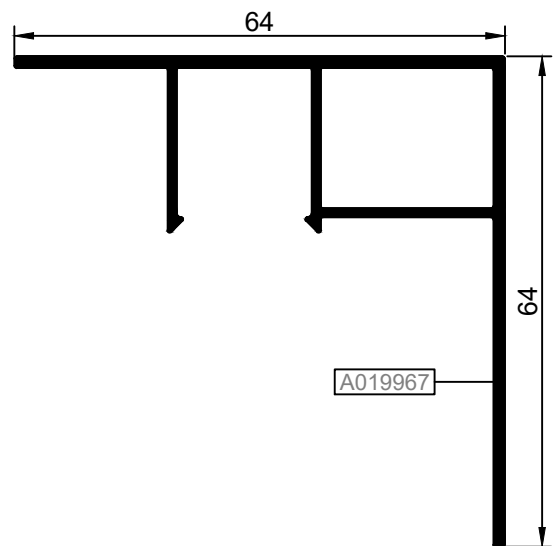

KOD / CODE	AĞIRLIK (kg/m) / WEIGHT	L m	KOD / CODE	AĞIRLIK (kg/m) / WEIGHT	L m
TC22C02	0,919	6			
A011039	1,447	6			
TC22M05	0,663	6			

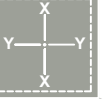

A011039

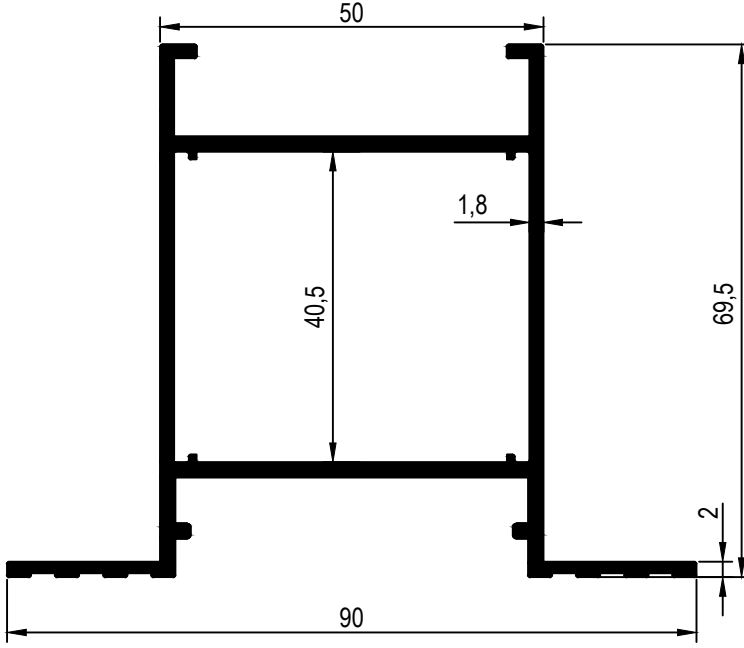

TC22M05

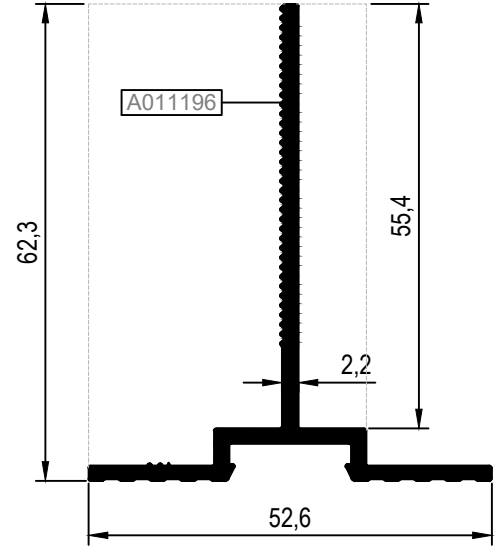

TC22C02

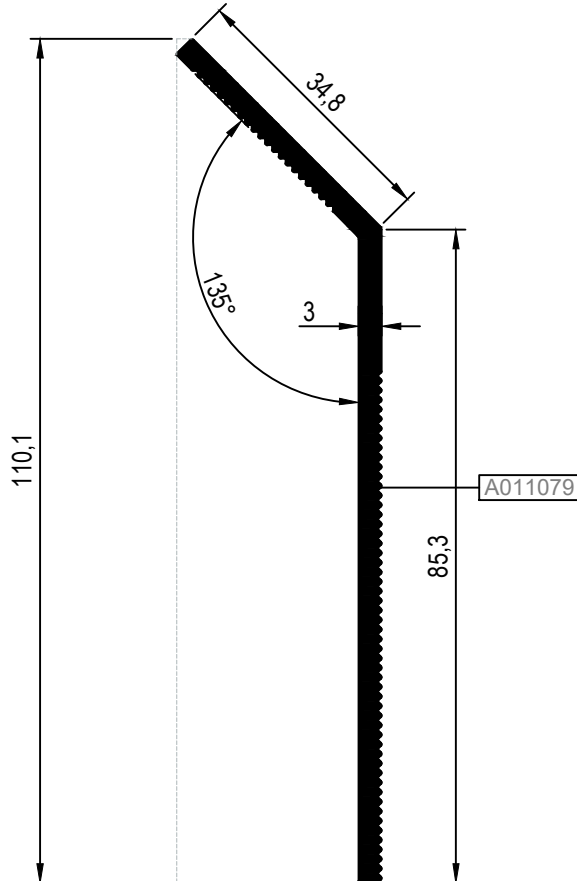

MİMARİ KATALOG
ARCHITECTURAL CATALOGUE

Alüminyum Konvansiyonel Sistemler
Aluminium Conventional Systems

RSP22

DETAYLAR

DETAILS

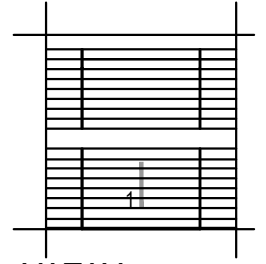
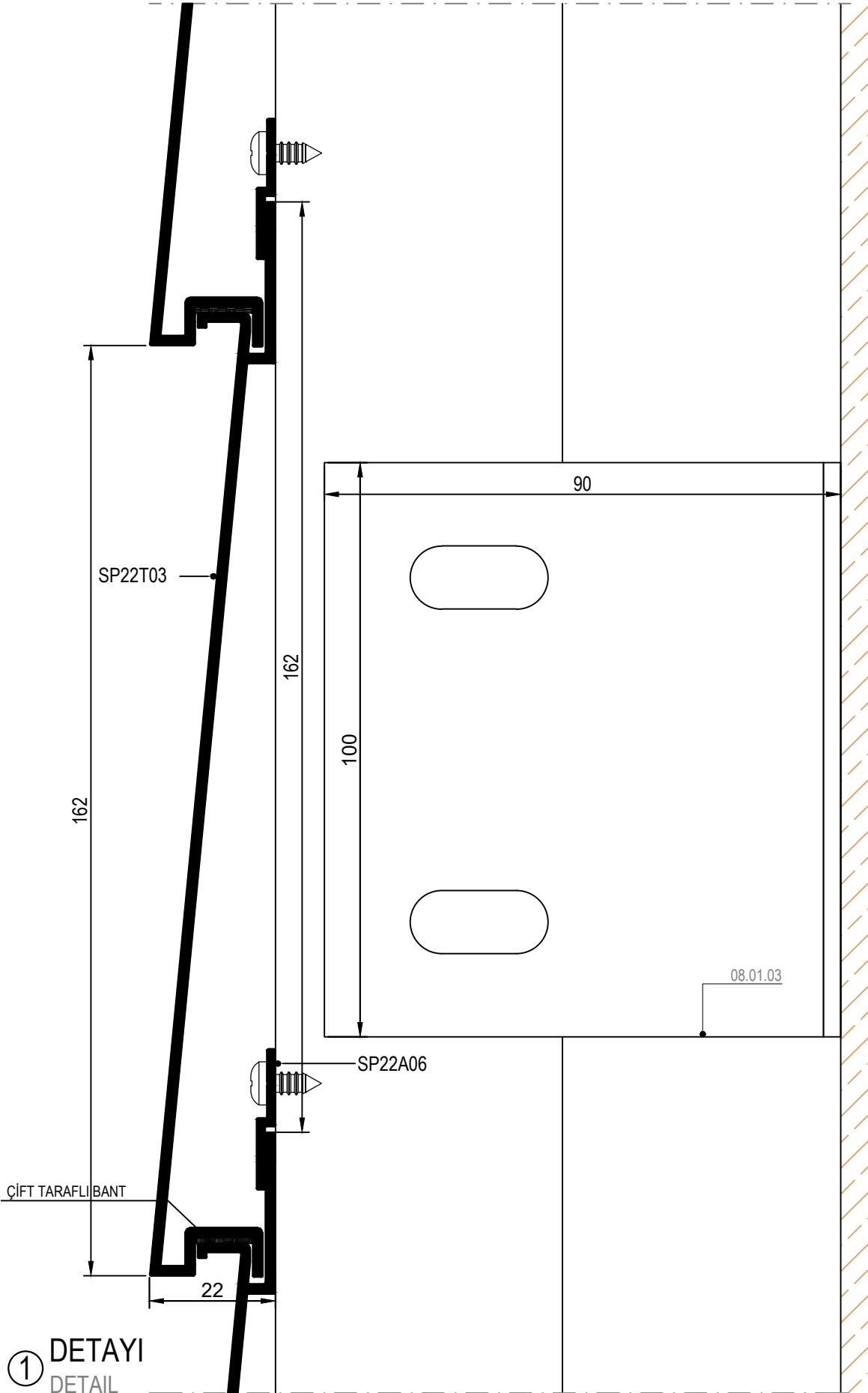

YATAY
HORIZONTAL

① DETAYI
DETAIL

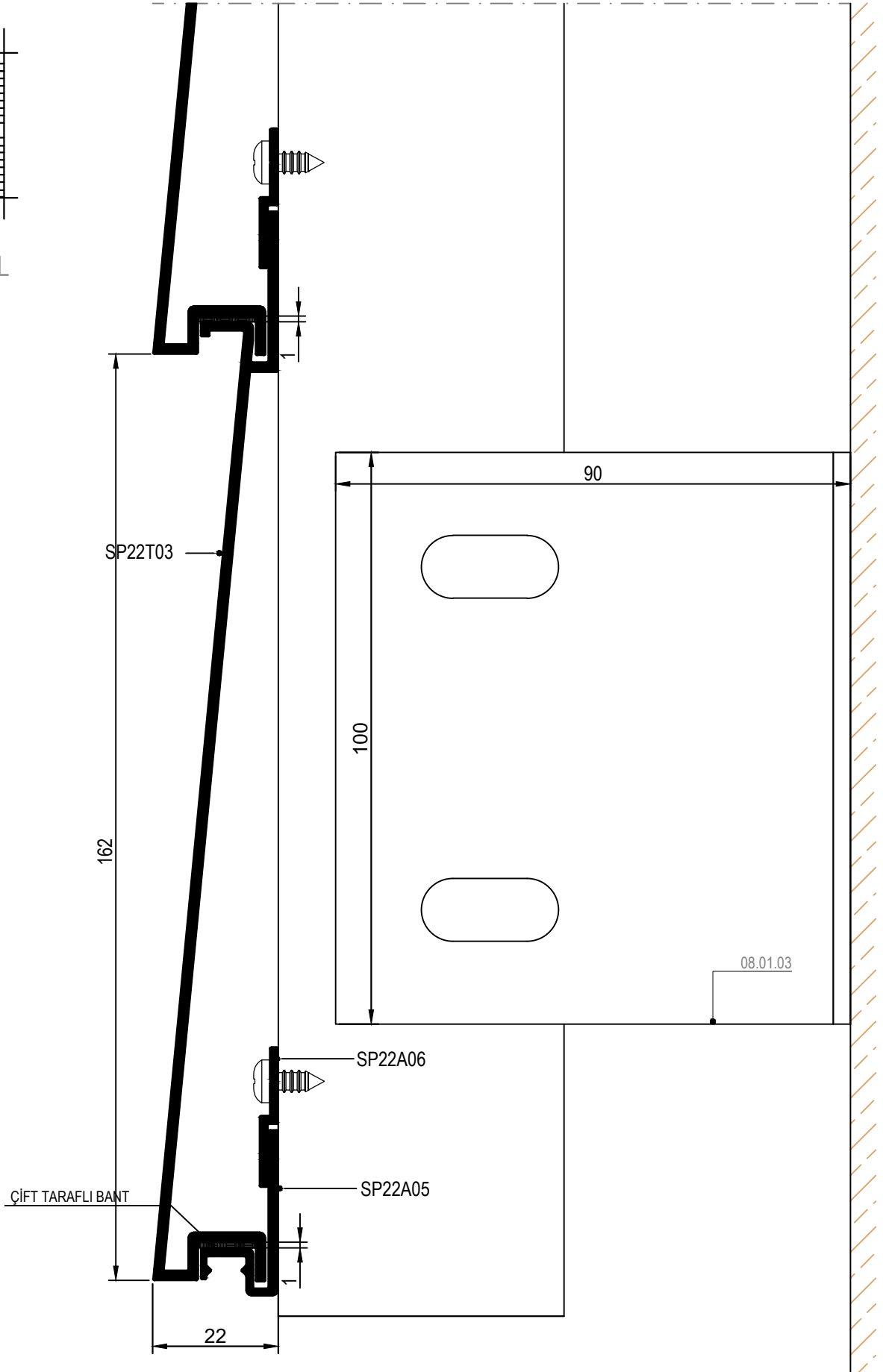
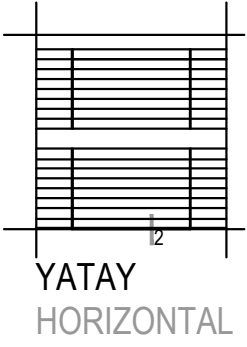

② DETAYI
DETAIL

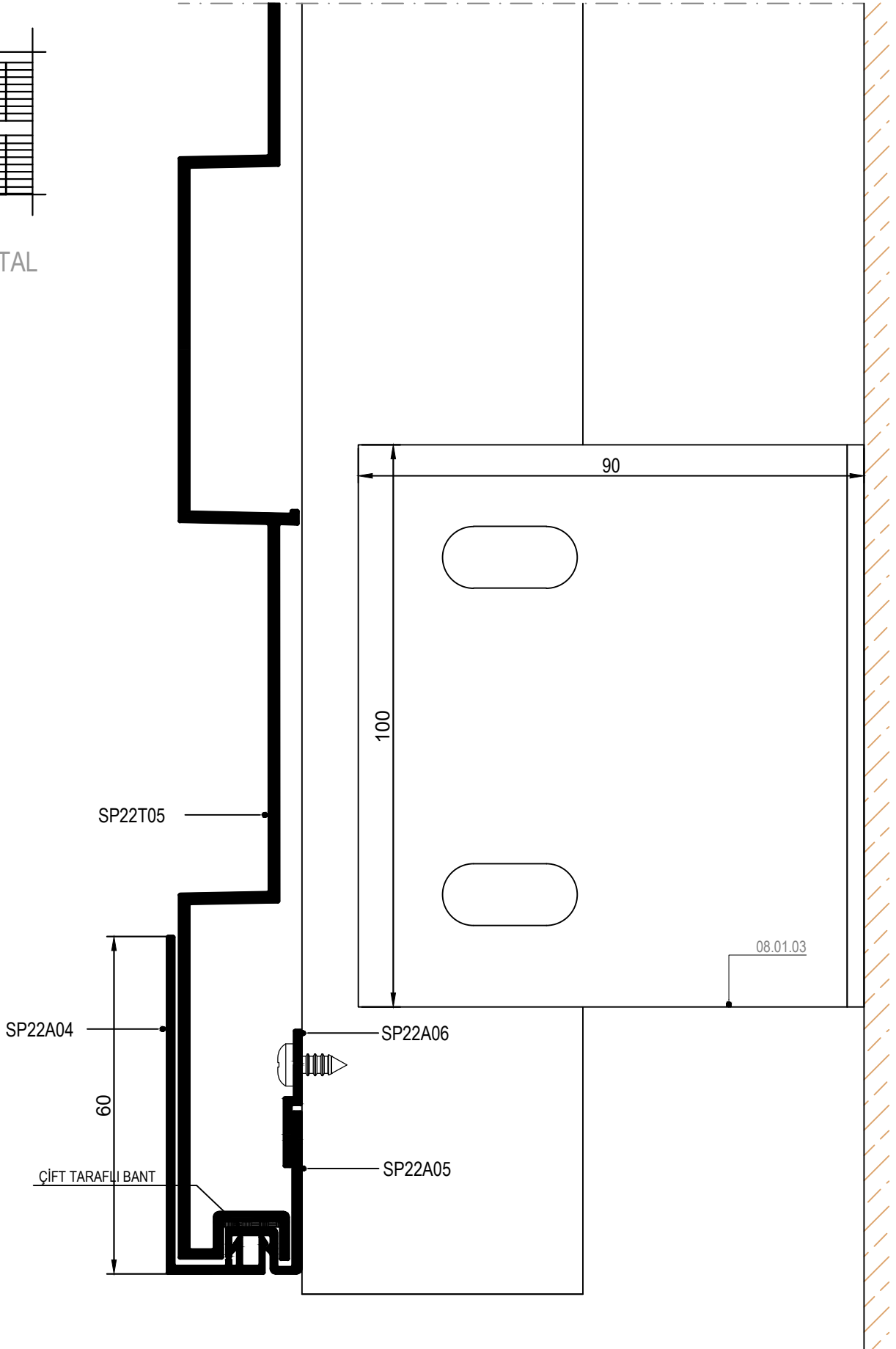
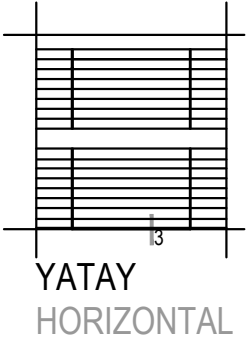

③ DETAYI
DETAIL

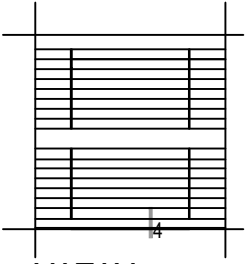

YATAY
HORIZONTAL

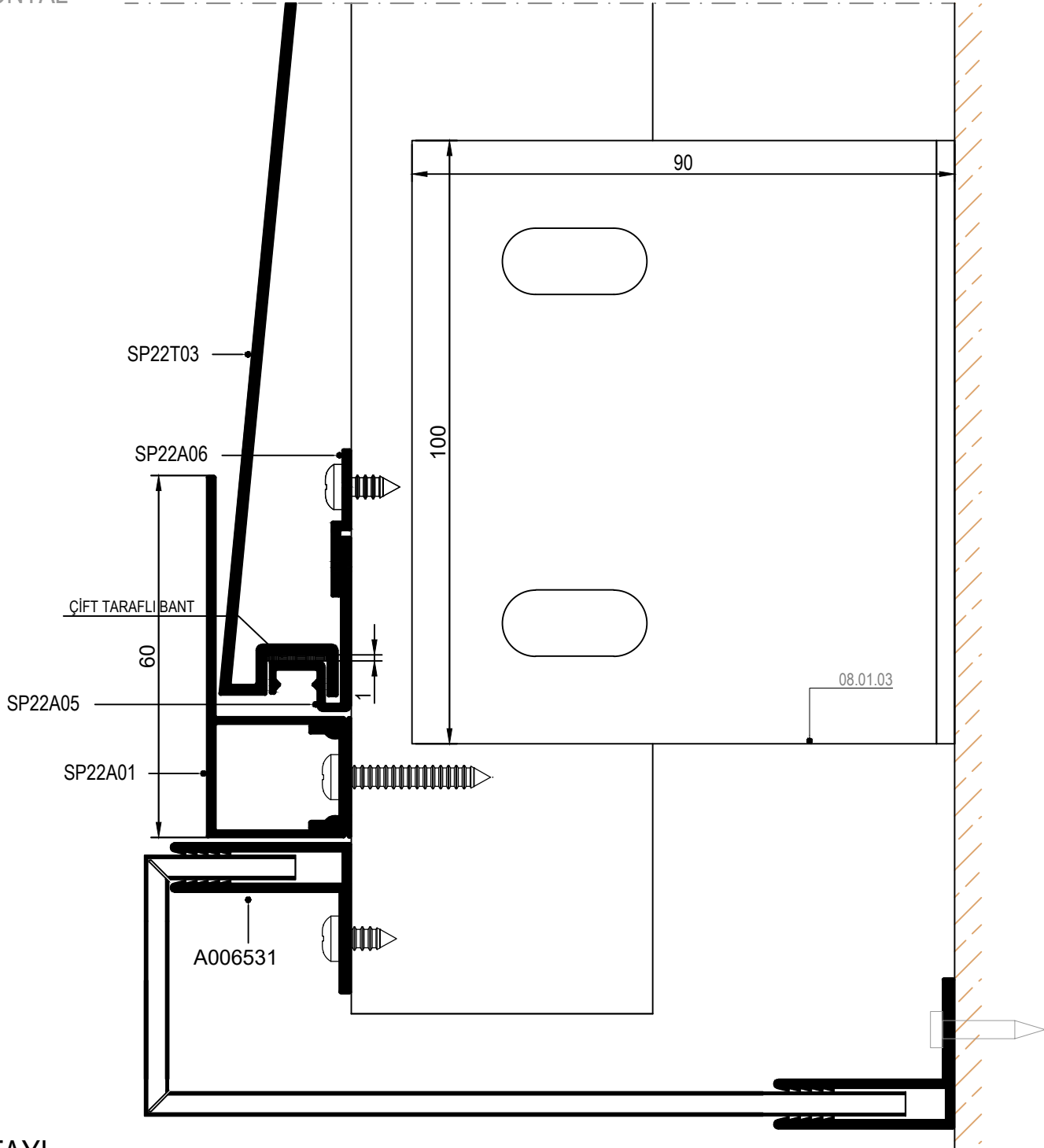

④ DETAYI
DETAIL

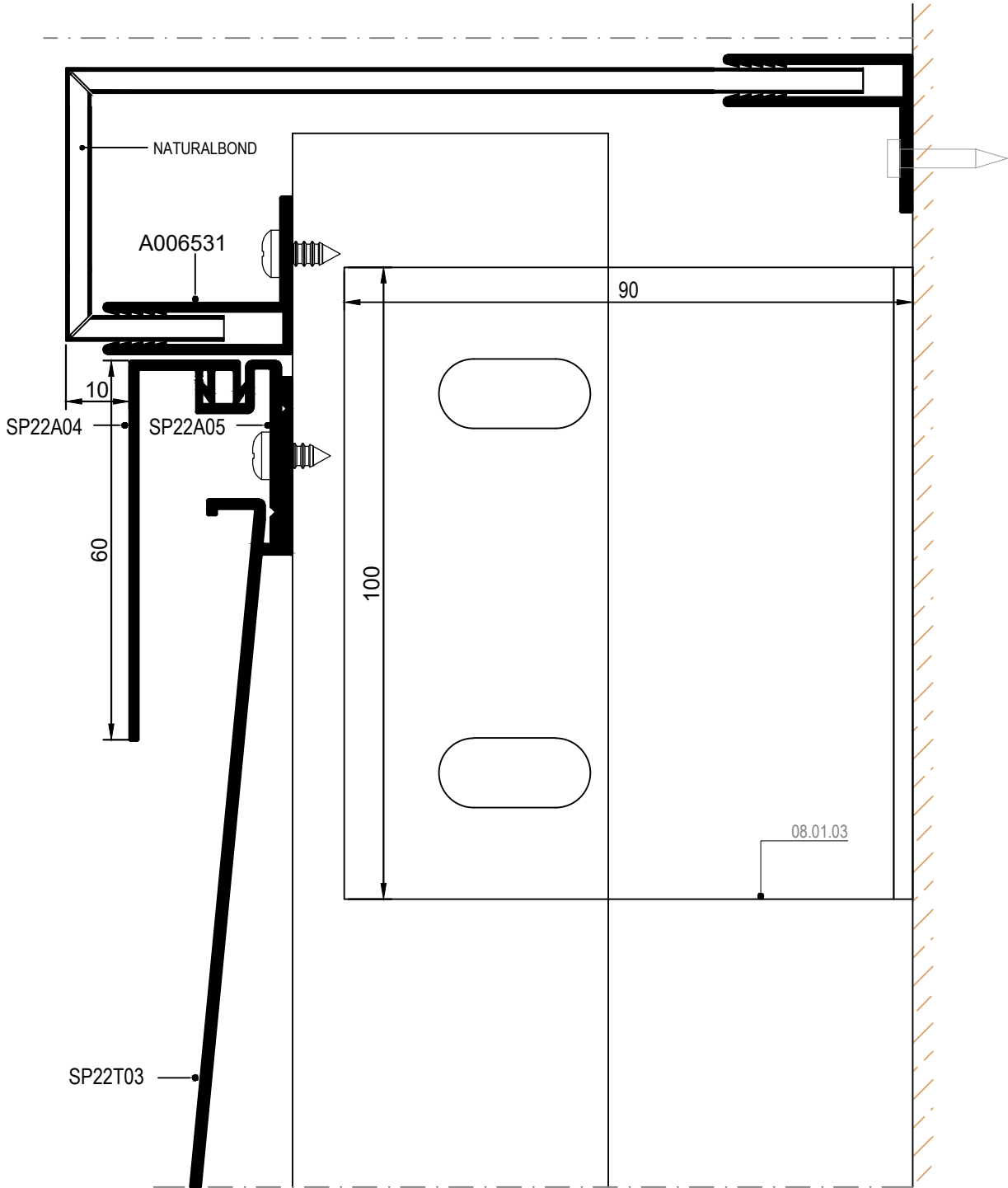
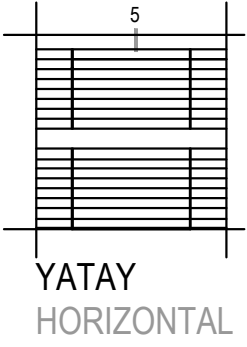

⑤ DETAYI
DETAIL

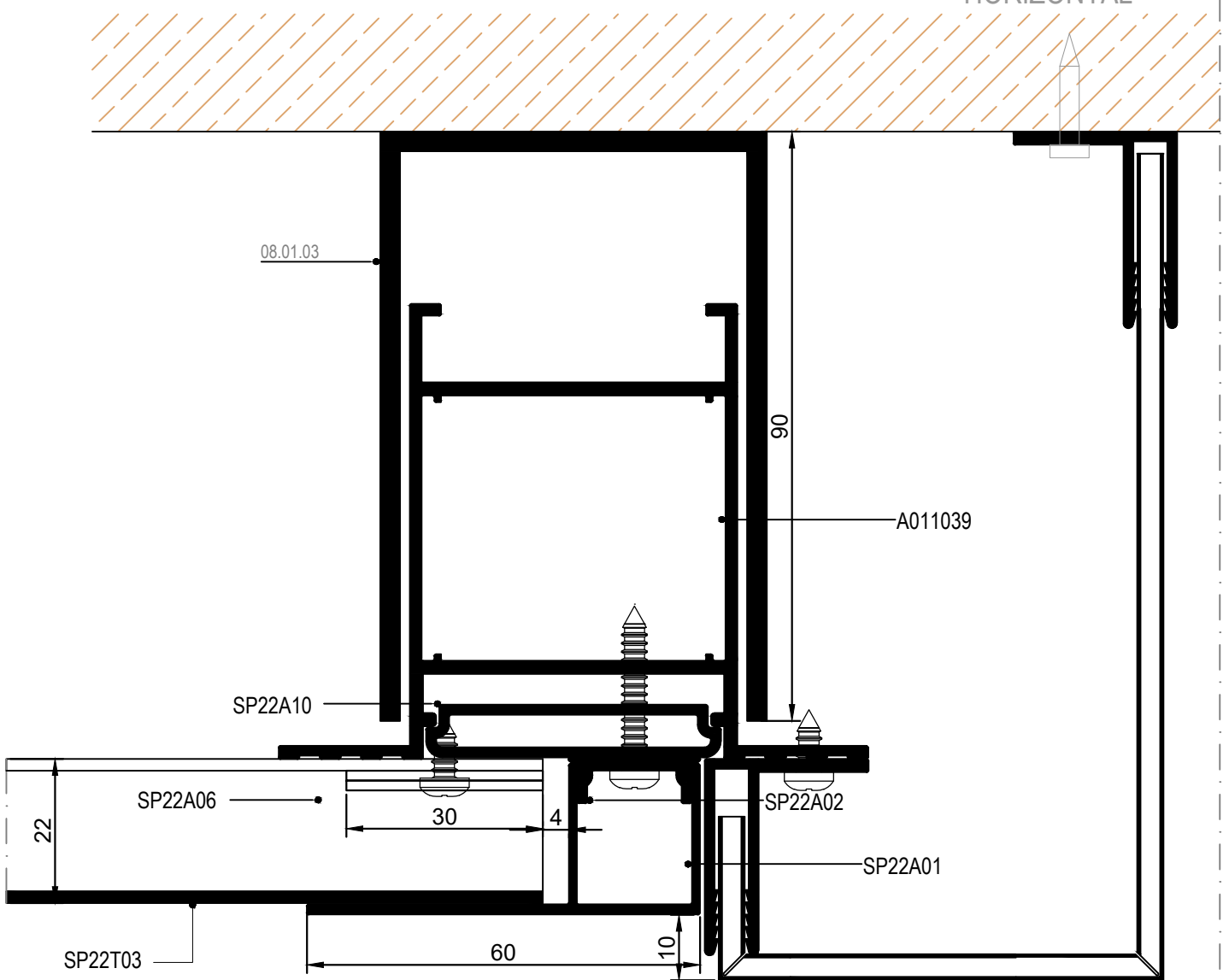
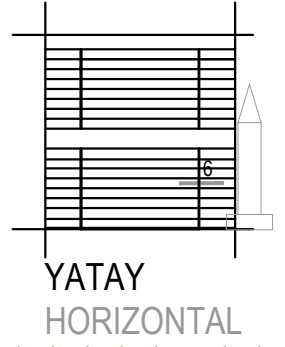

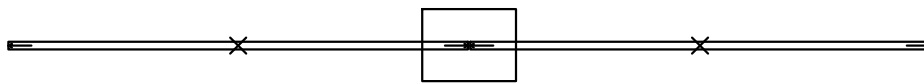
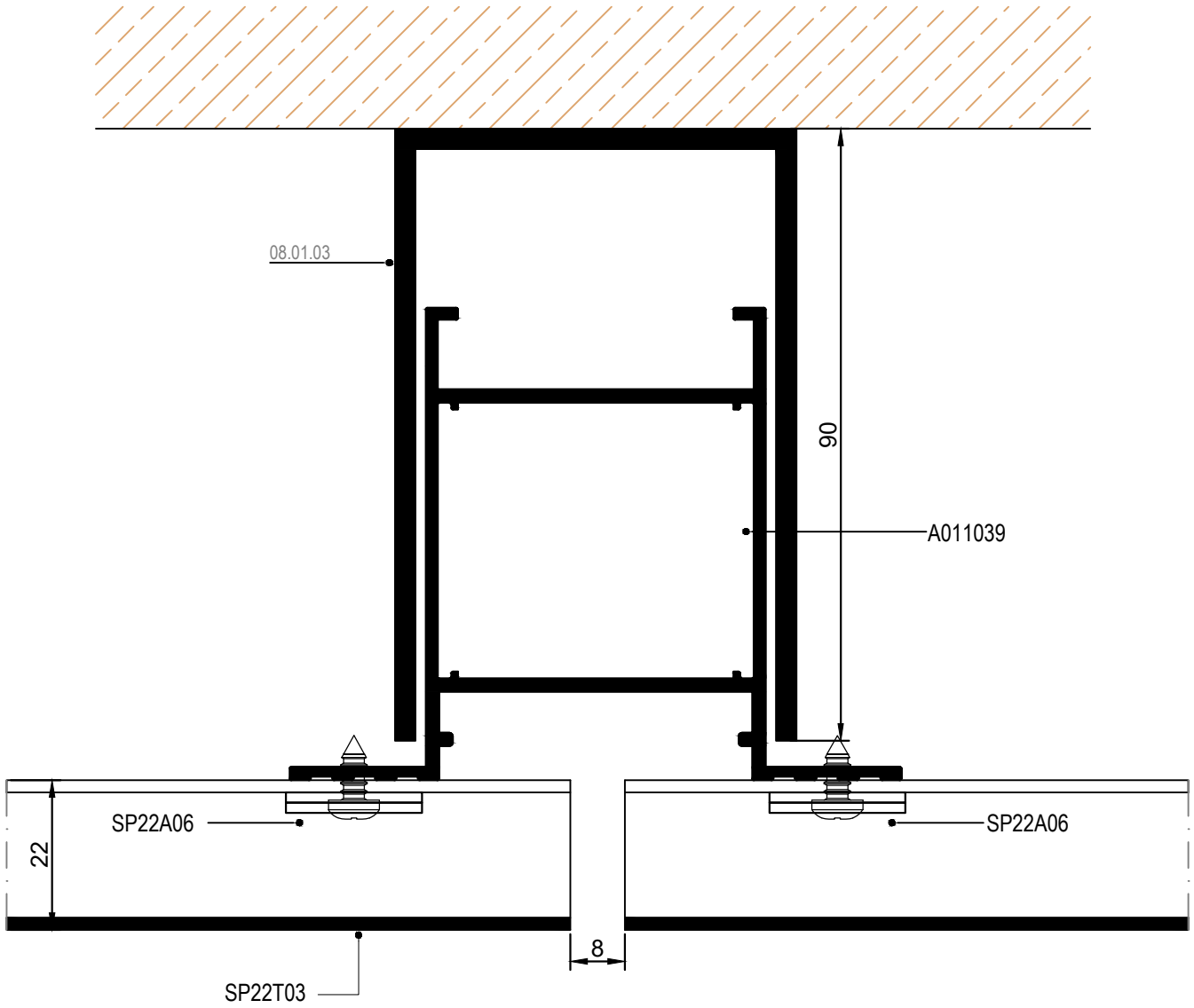
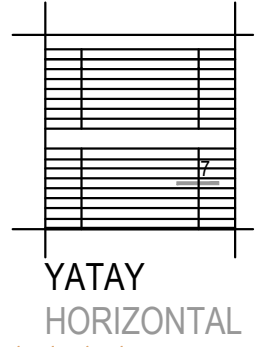

ISIL GENLEŞME SERBESTLİKLERİ
THERMAL EXPANSION RELEASES

⑦ DETAYI
DETAIL

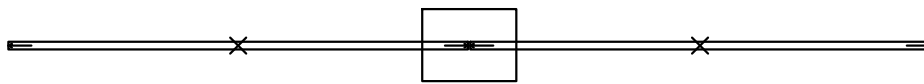
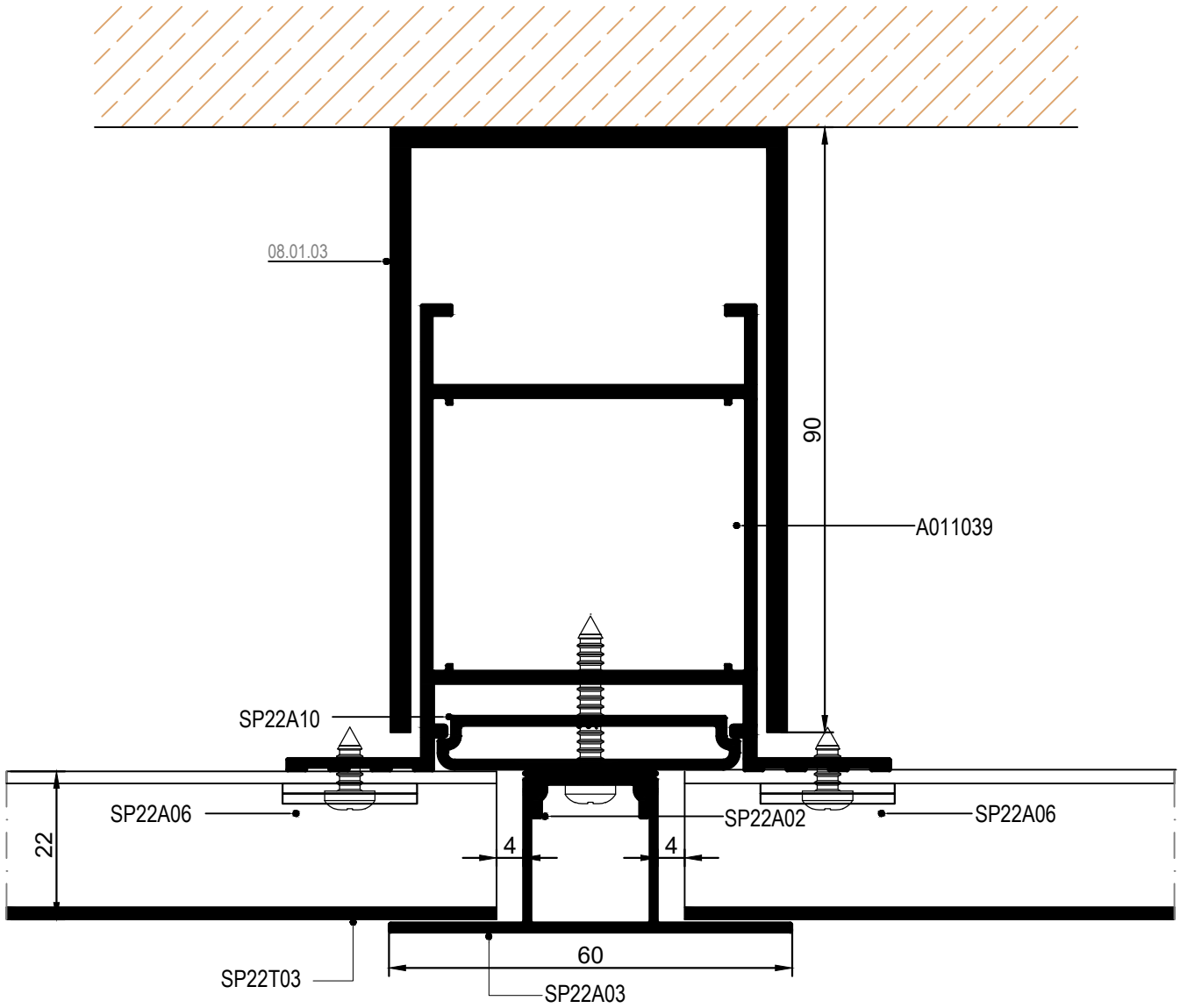
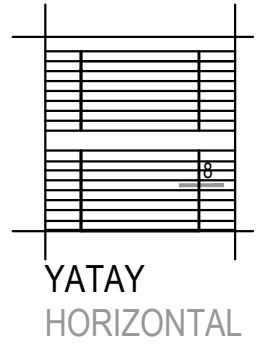

ISIL GENLEŞME SERBESTLİKLERİ
THERMAL EXPANSION RELEASES

⑧ DETAYI
DETAIL

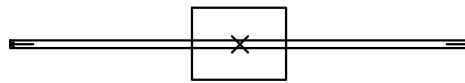
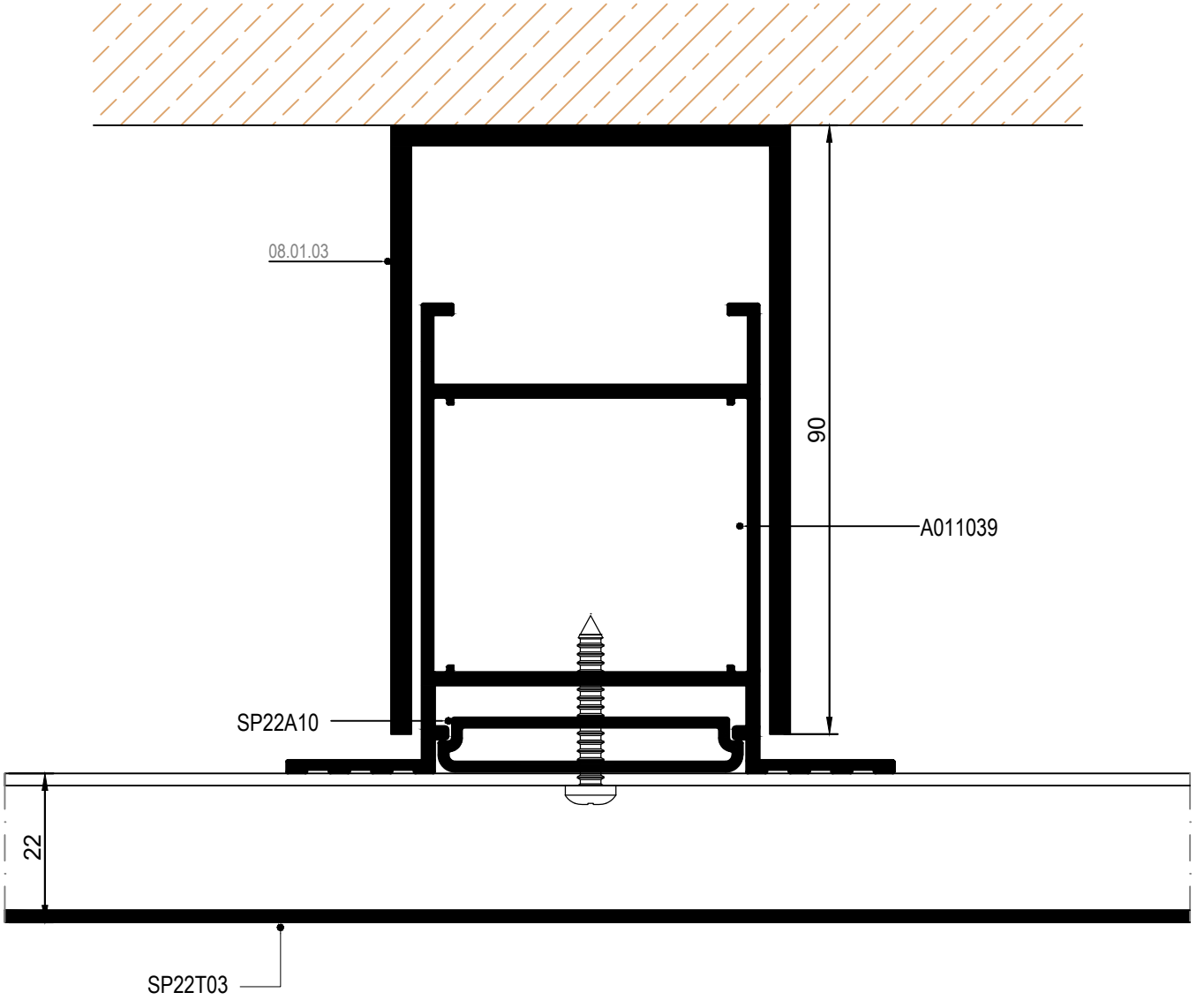
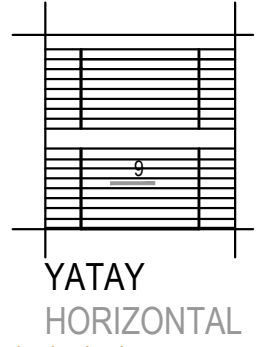

ISIL GENLEŞME SERBESTLİKLERİ
THERMAL EXPANSION RELEASES

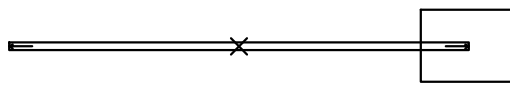
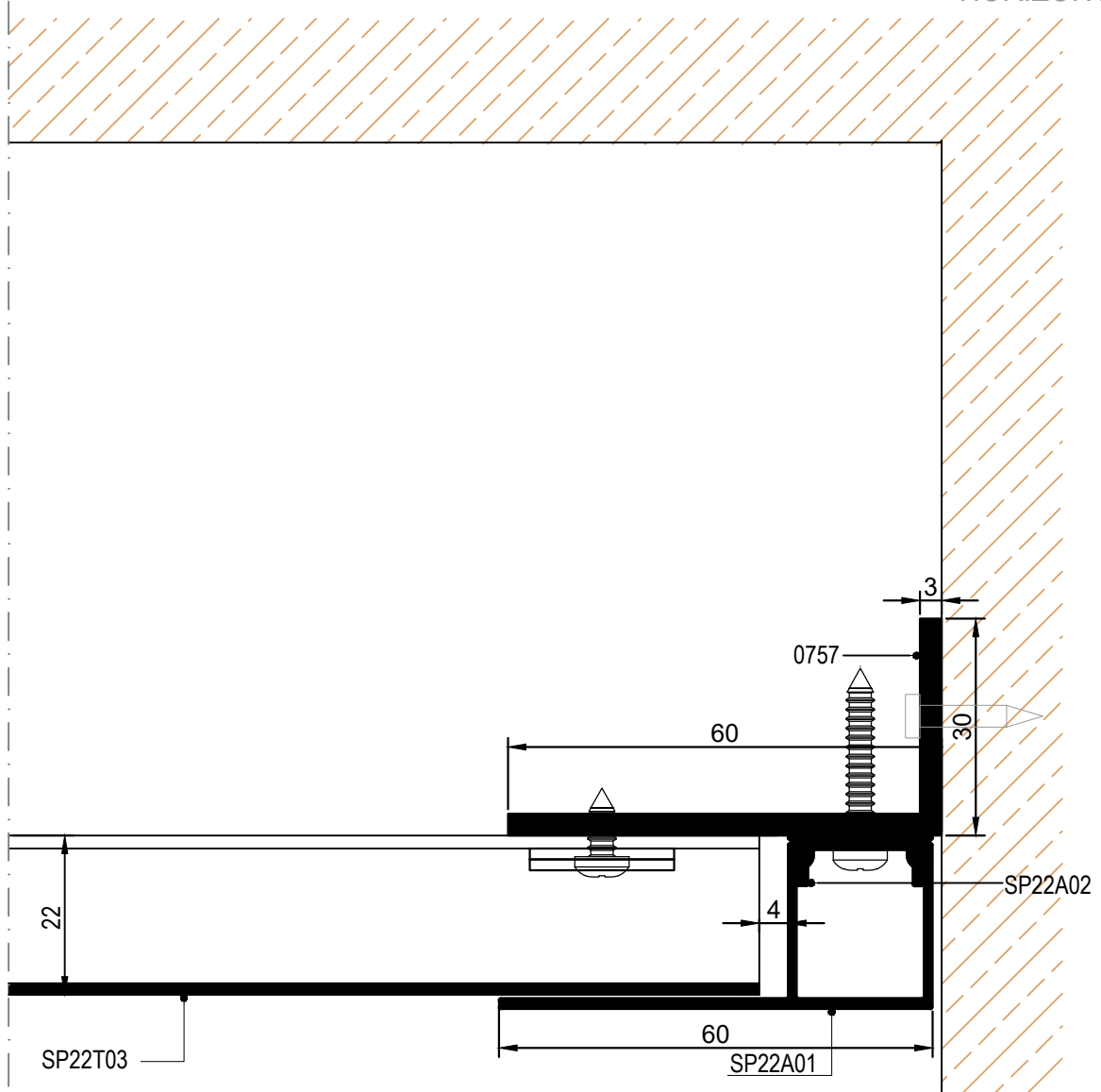
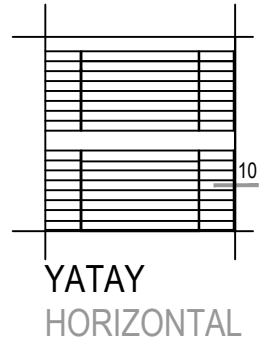

ISIL GENLEŞME SERBESTLİKLERİ
THERMAL EXPANSION RELEASES

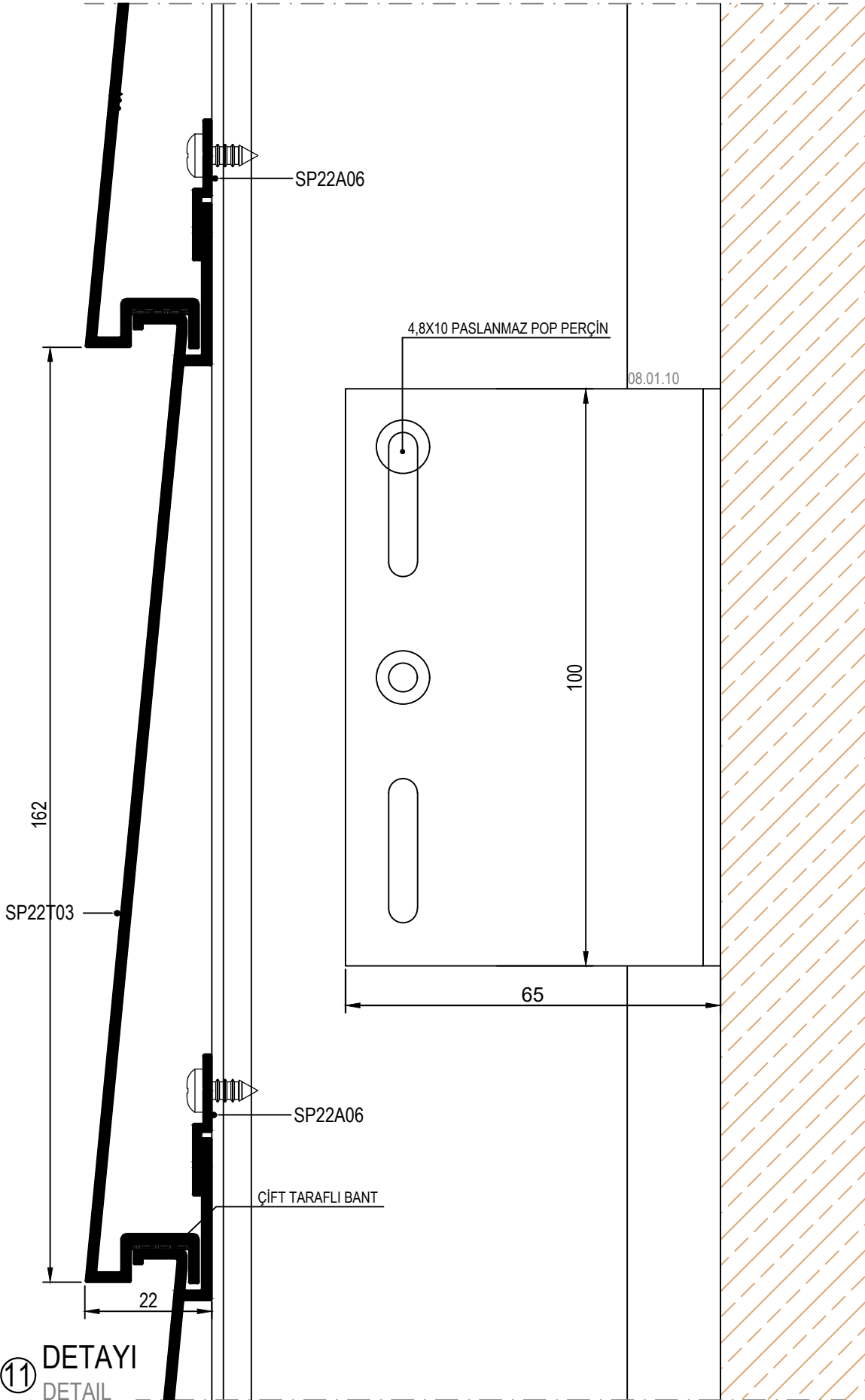

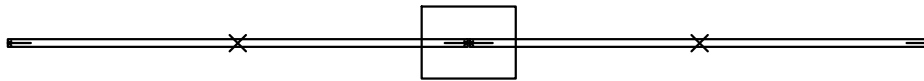
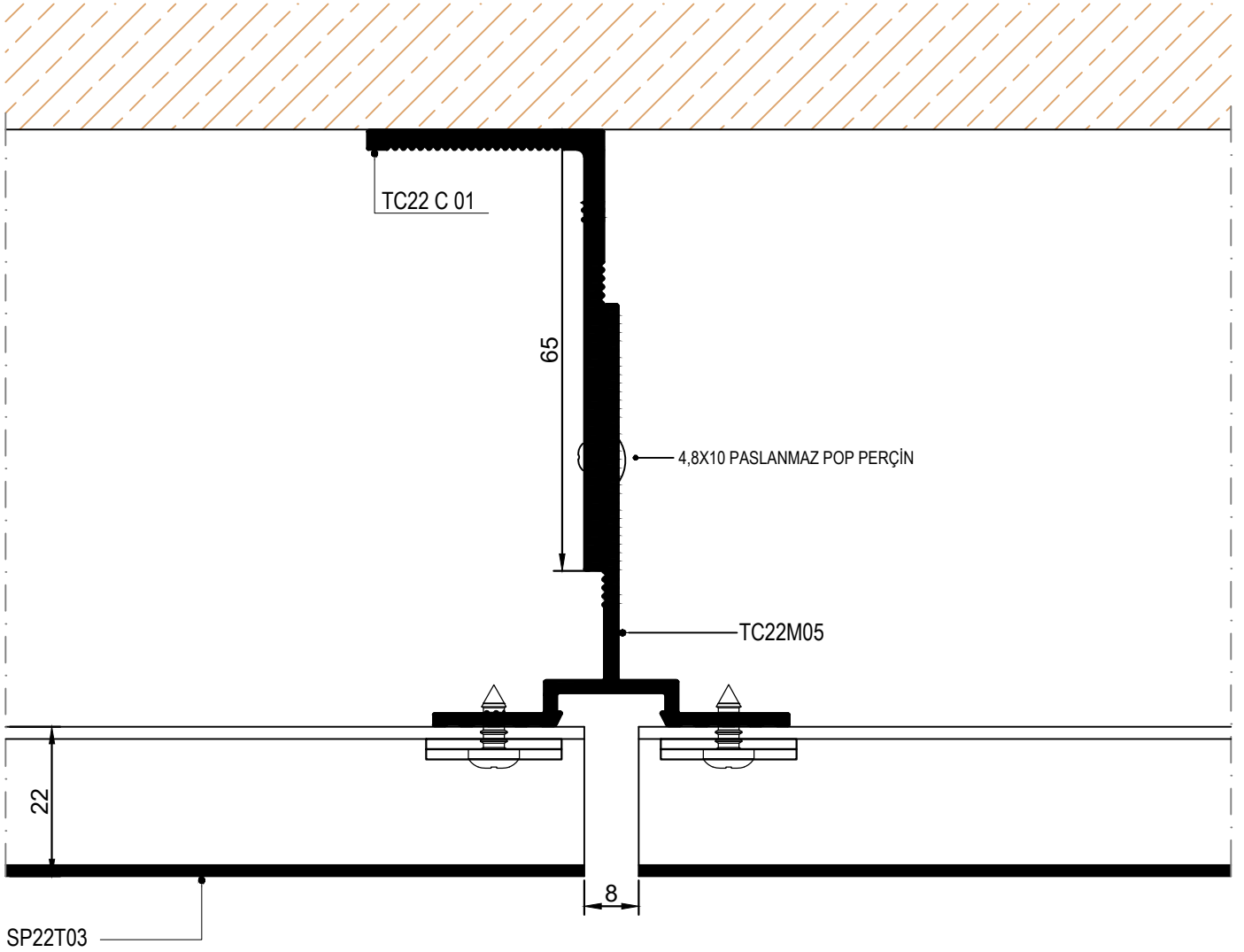
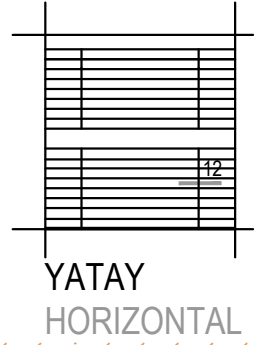

ISIL GENLEŞME SERBESTLİKLERİ
THERMAL EXPANSION RELEASES

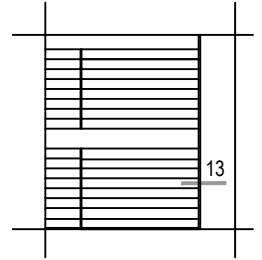

YATAY
HORIZONTAL

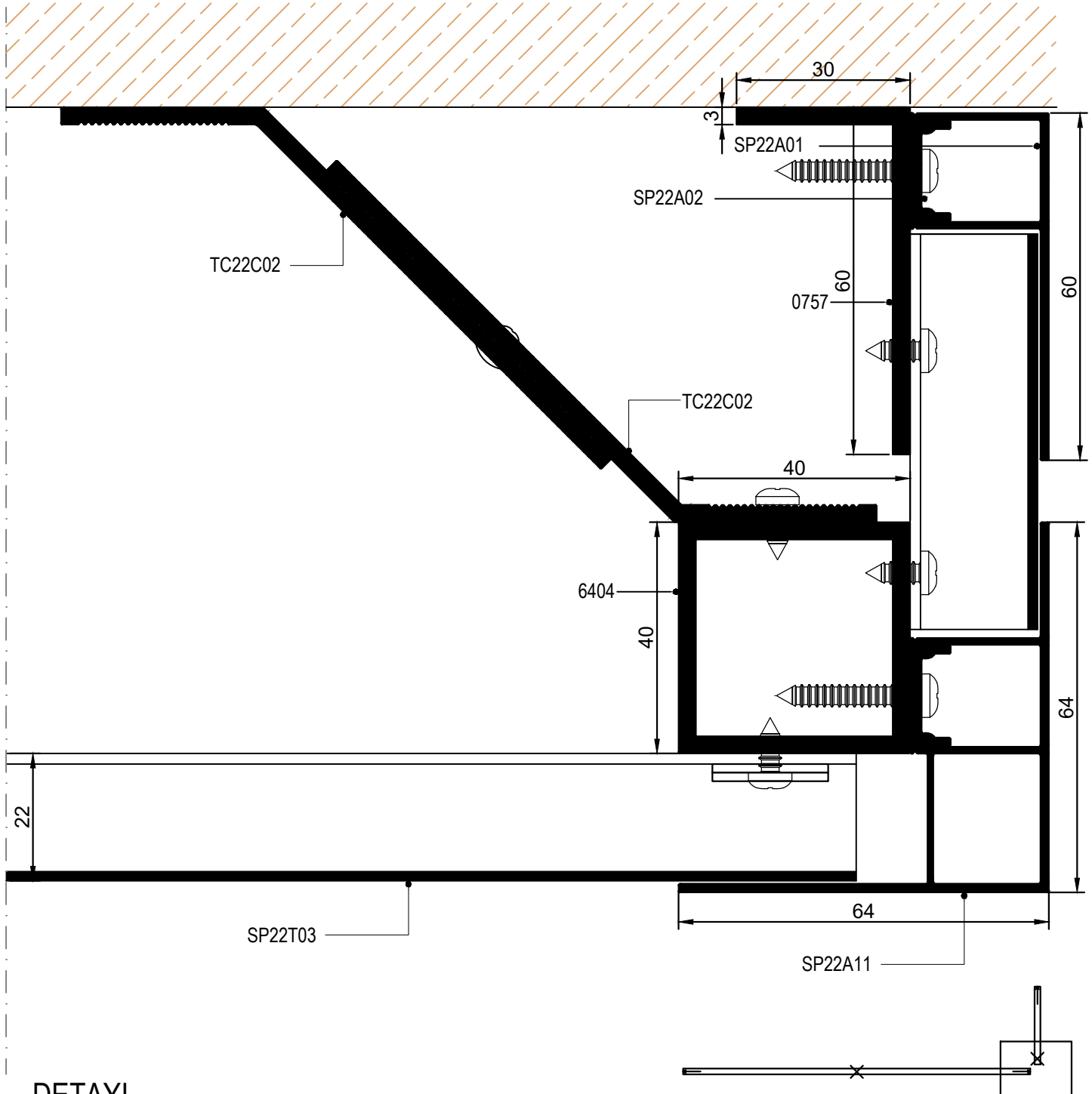

13 DETAYI
DETAIL

ISIL GENLEŞME SERBESTLİKLERİ
THERMAL EXPANSION RELEASES

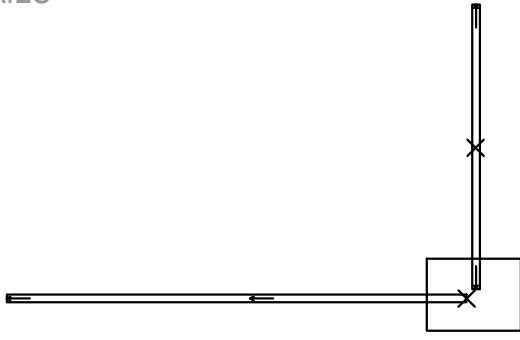

ISIL GENLEŞME SERBESTLİKLERİ
THERMAL EXPANSION RELEASES

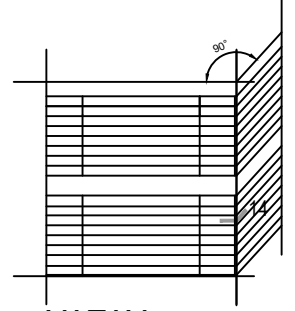

YATAY
HORIZONTAL

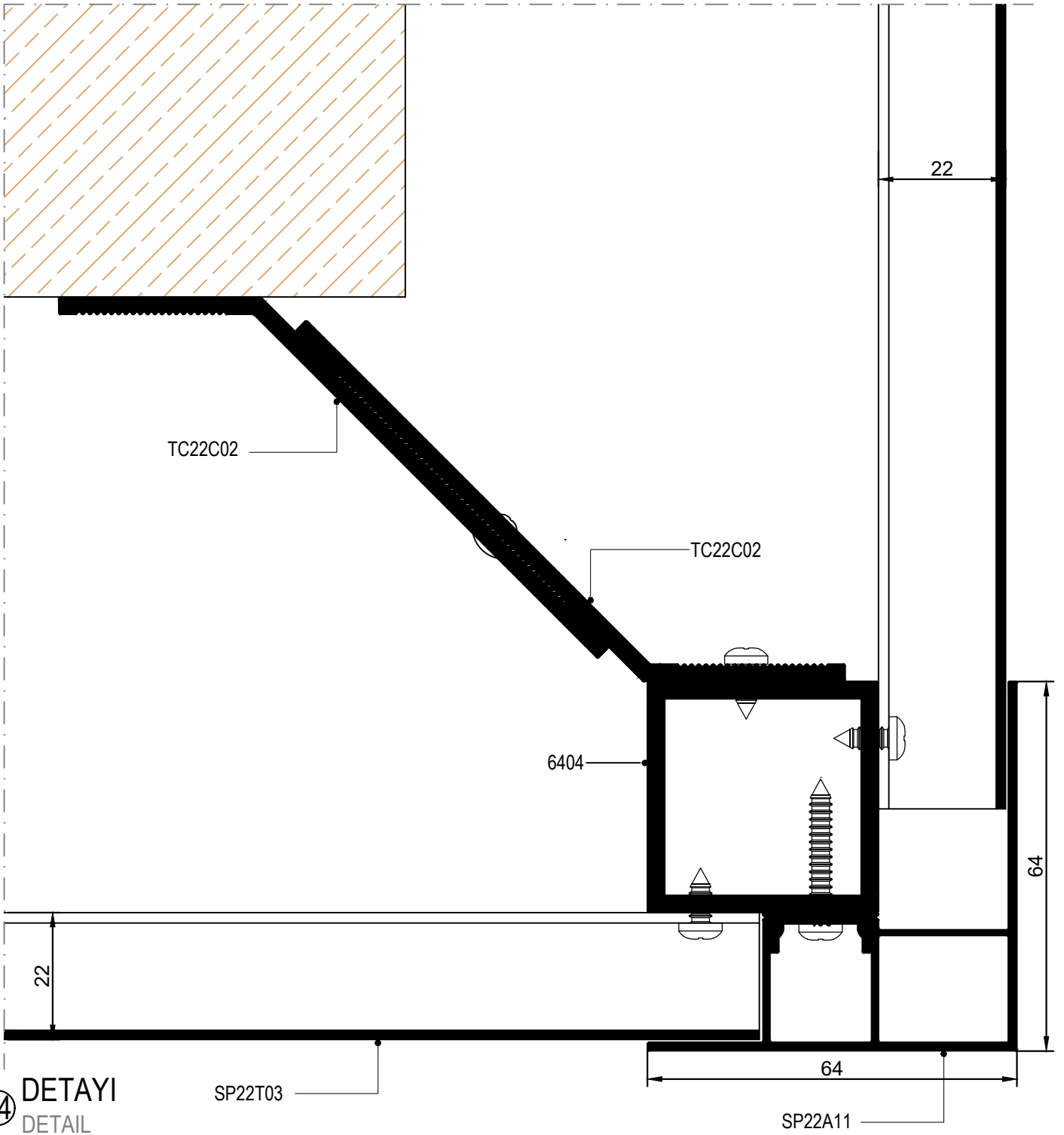

14 DETAYI
DETAIL

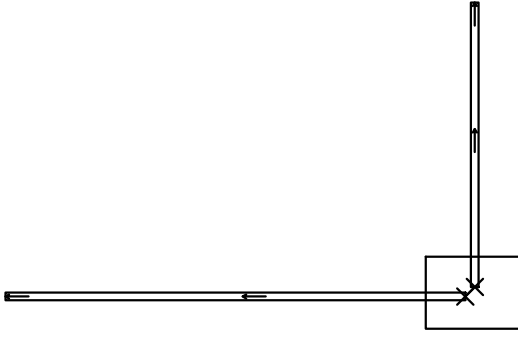

ISIL GENLEŞME SERBESTLİKLERİ
THERMAL EXPANSION RELEASES

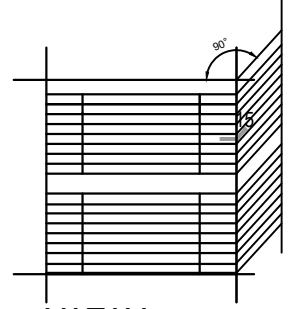

YATAY
HORIZONTAL

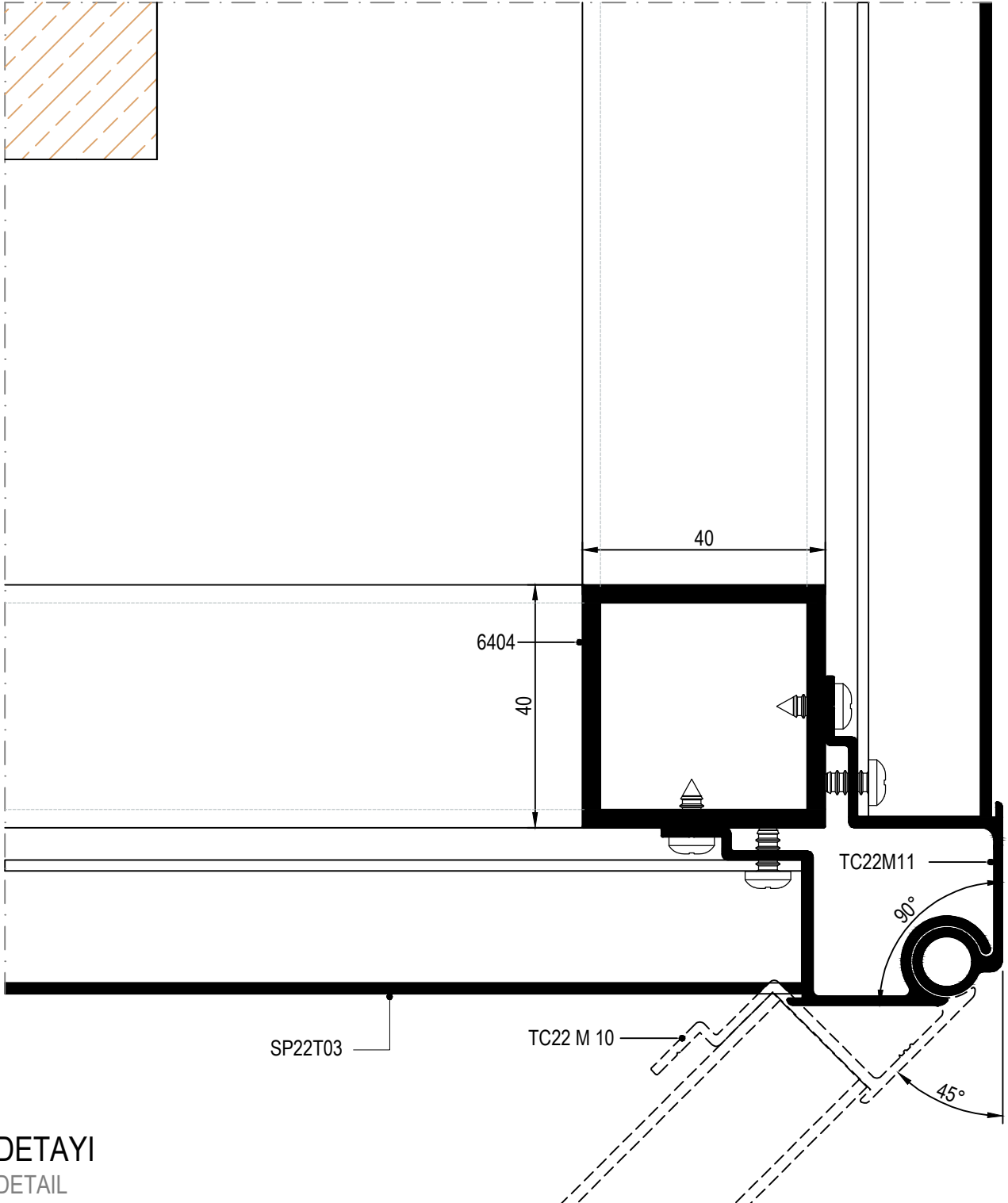

15 DETAYI
DETAIL

ISIL GENLEŞME SERBESTLİKLERİ
THERMAL EXPANSION RELASES

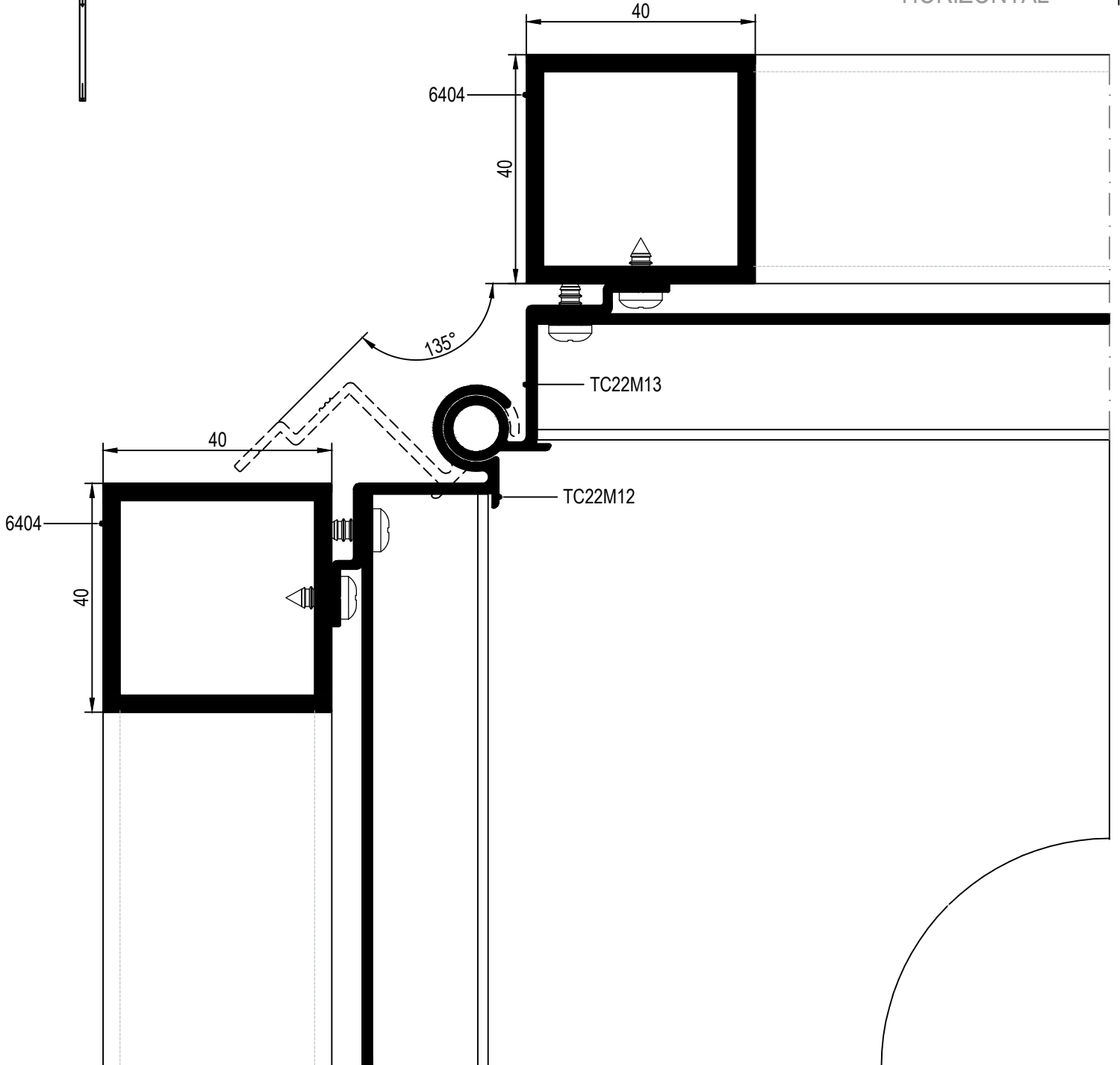
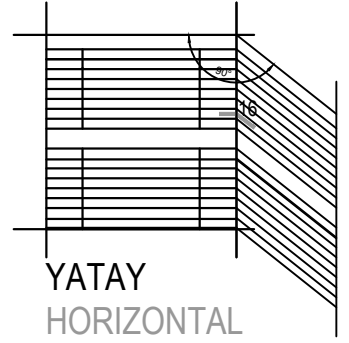
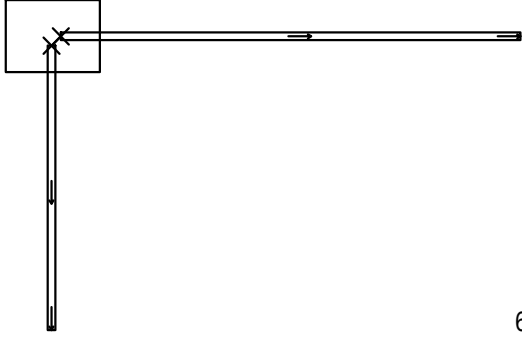

16 DETAYI
DETAIL

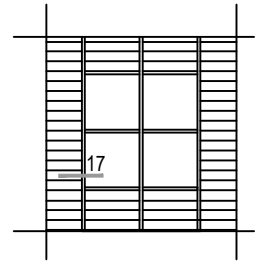

YATAY
HORIZONTAL

Front Side View

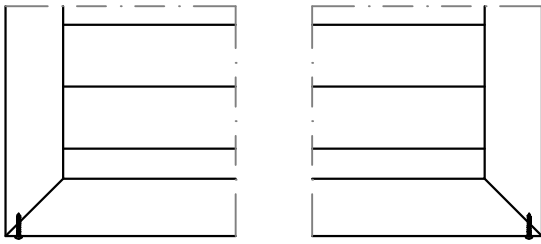
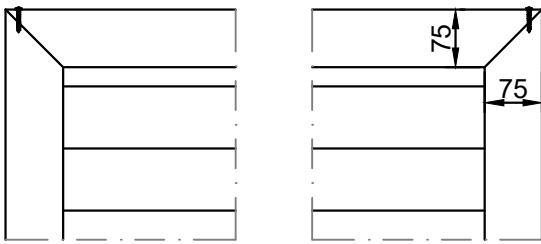

Scale 1/10

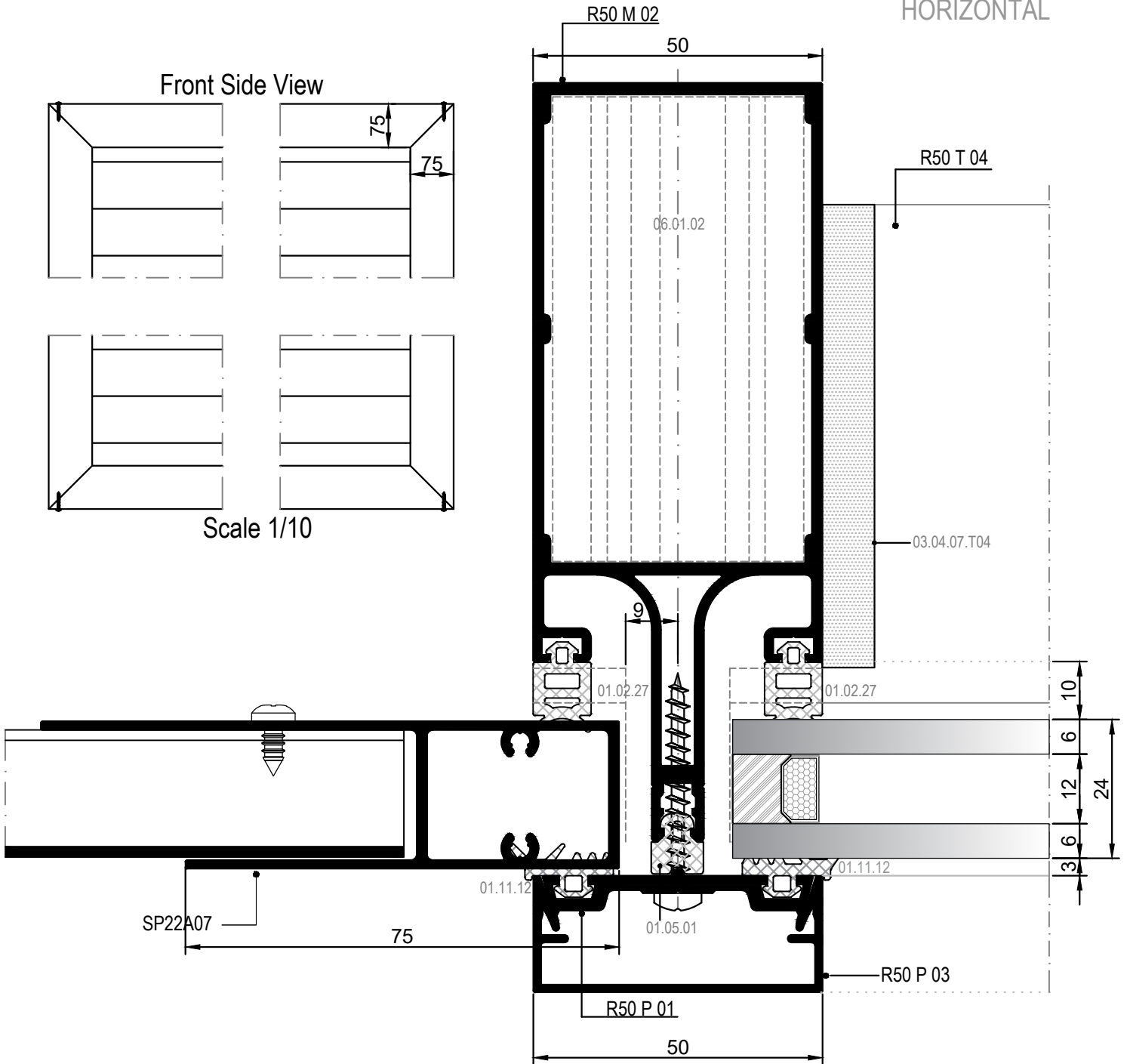

17 DETAYI
DETAIL

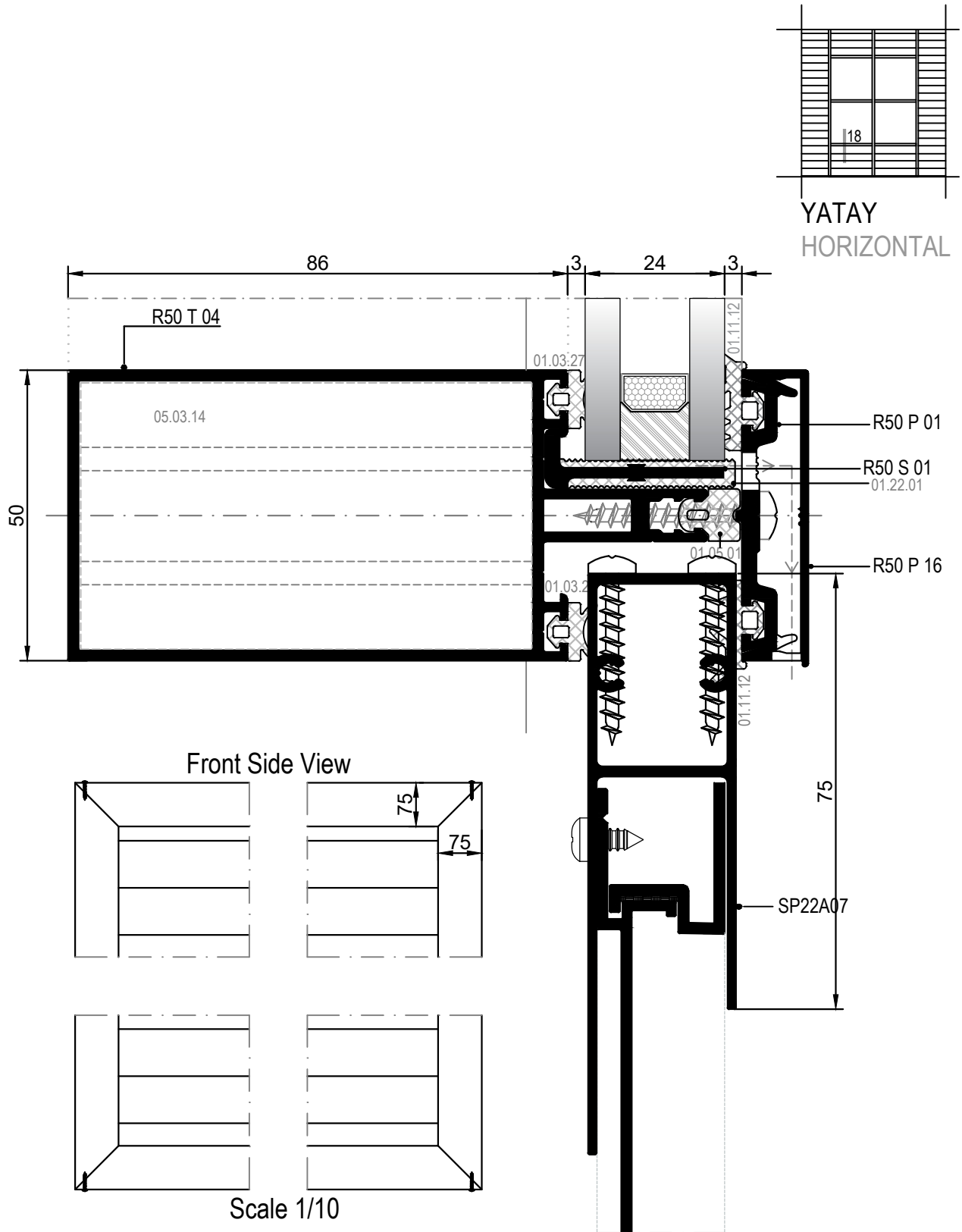

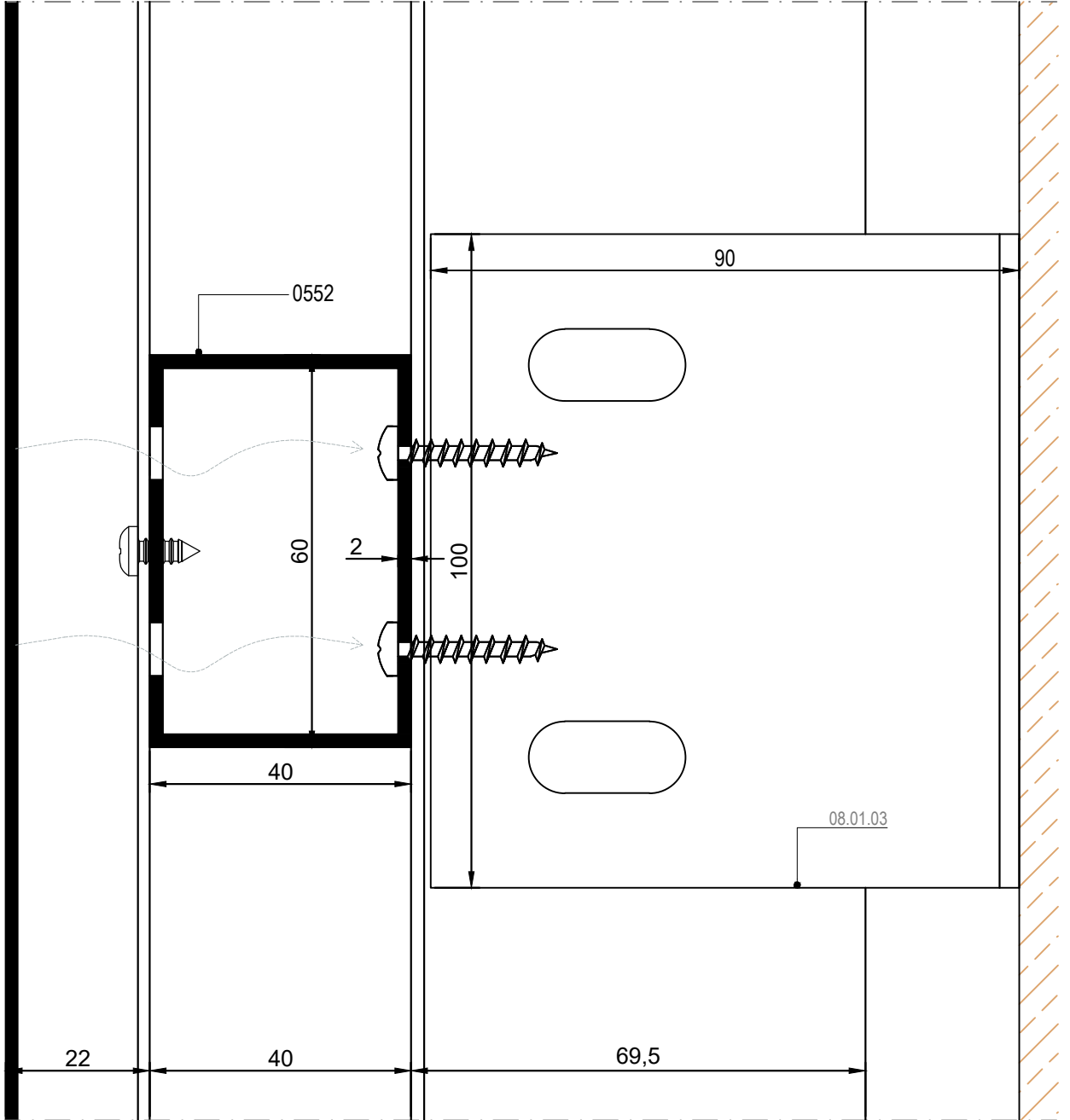
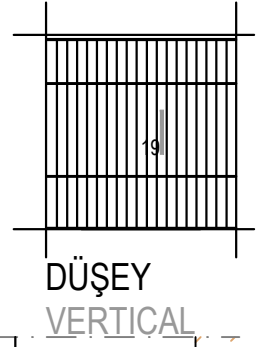

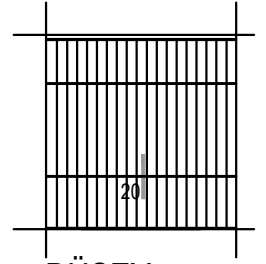

DÜŞEY
VERTICAL

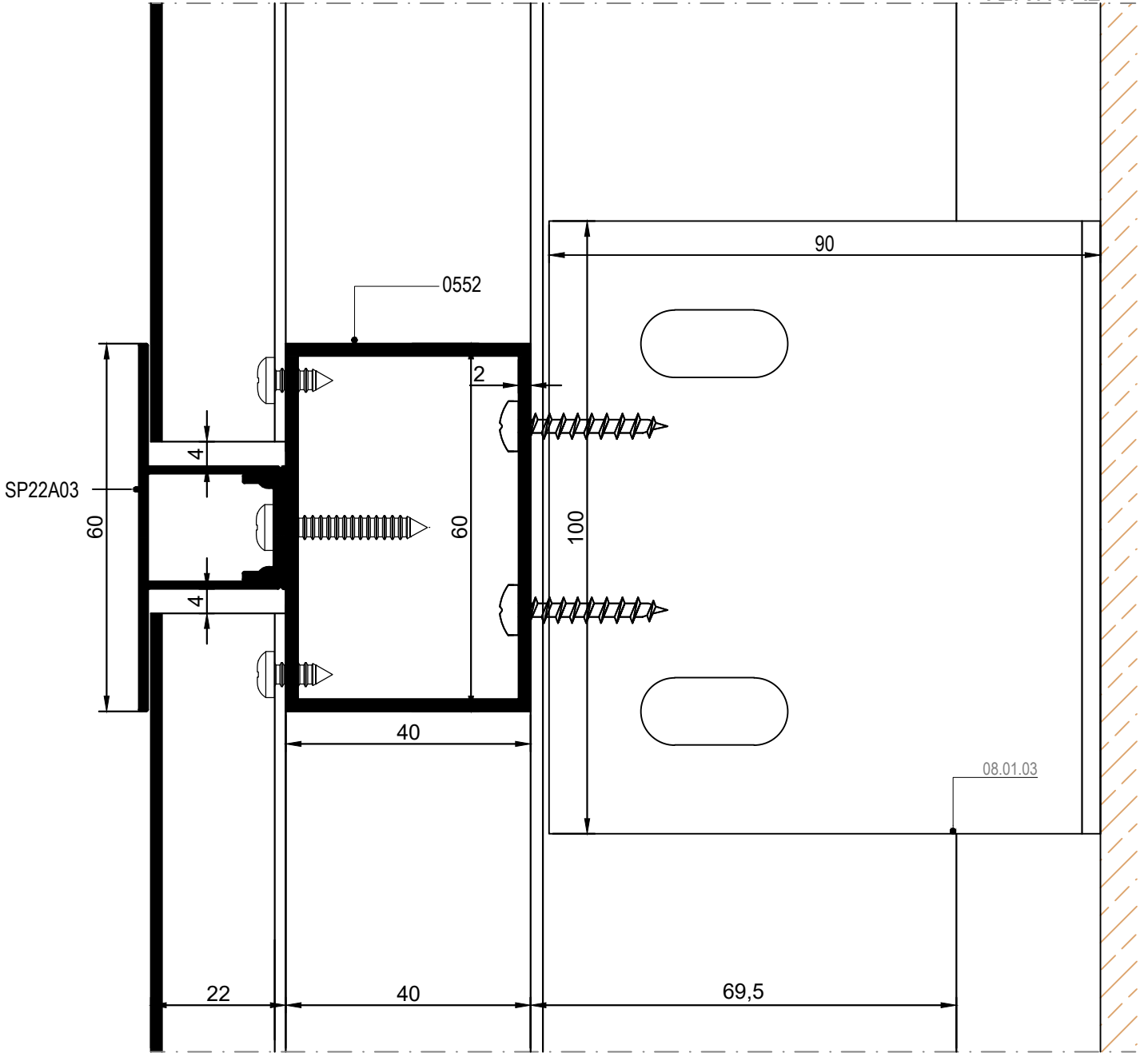

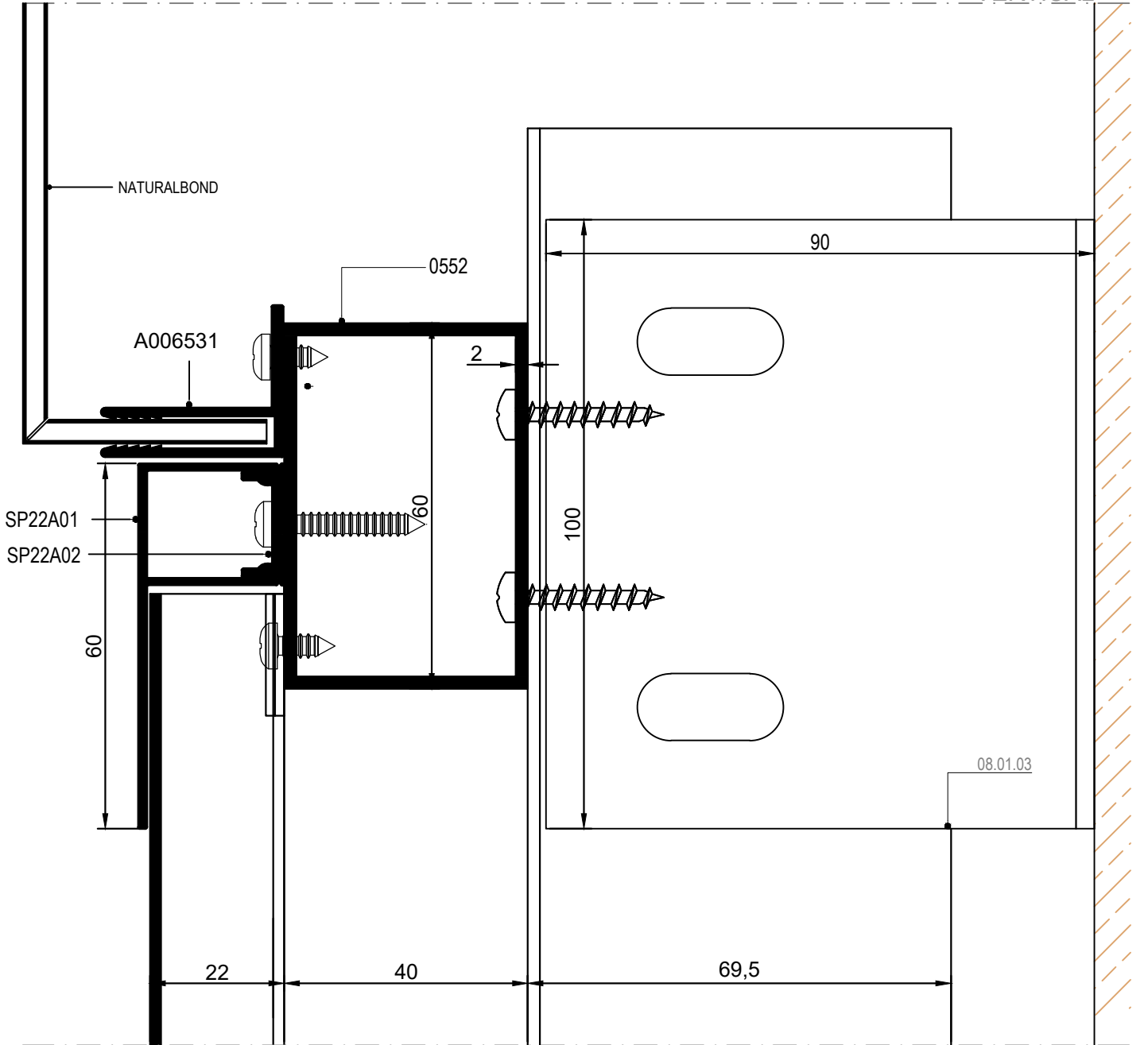
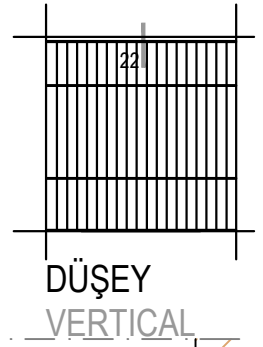

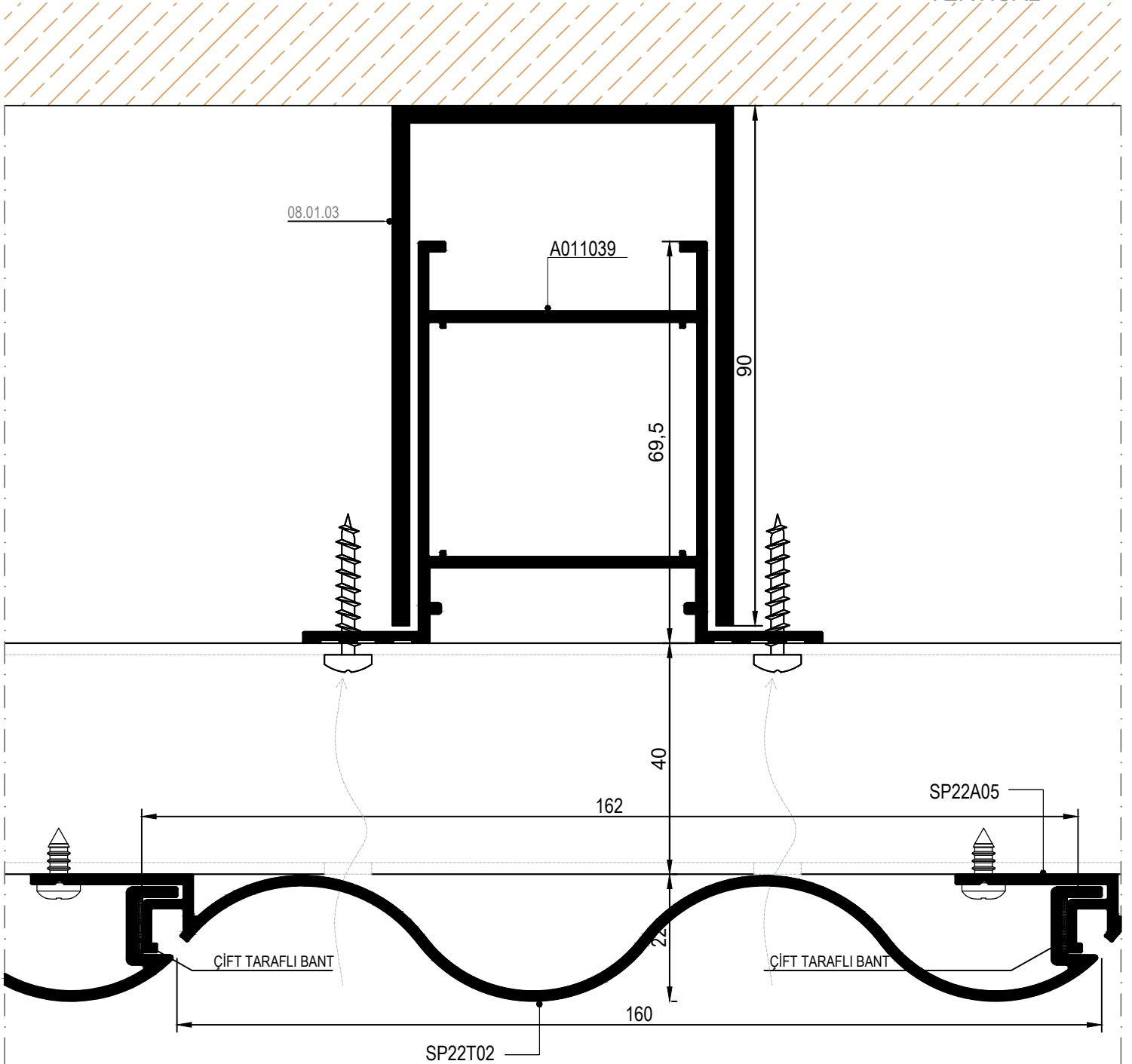
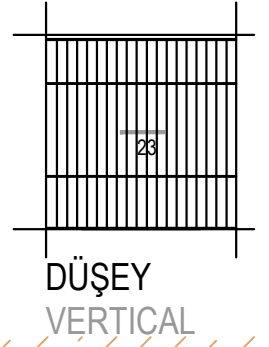

23 DETAYI
DETAIL

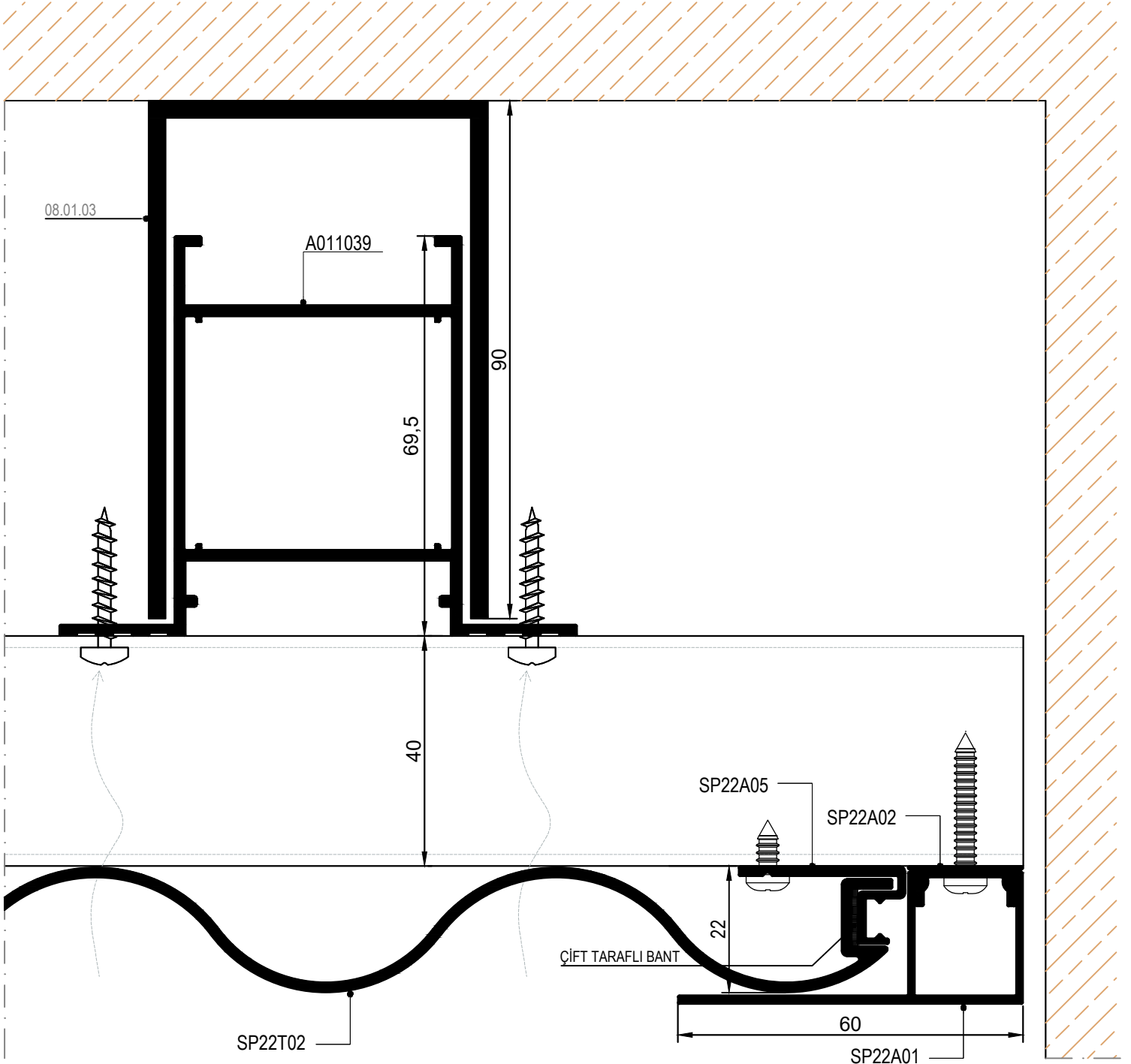
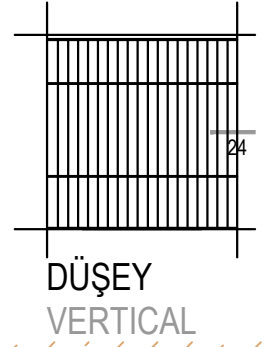

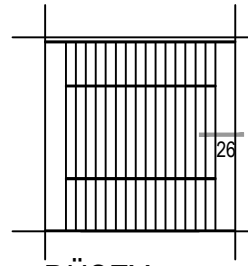

DÜŞEY
VERTICAL

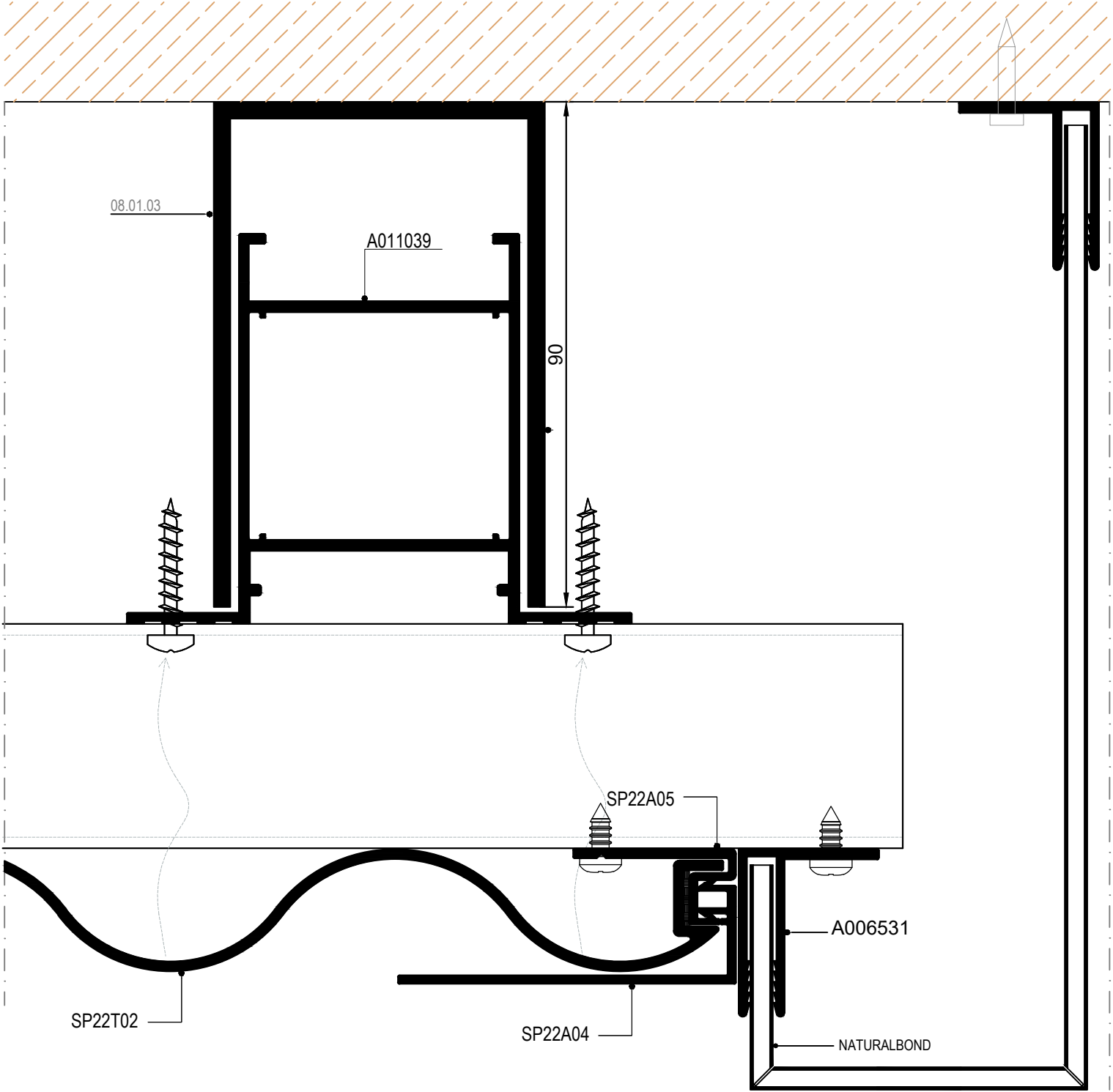

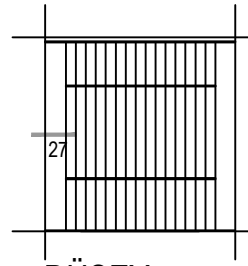

DÜŞEY
VERTICAL

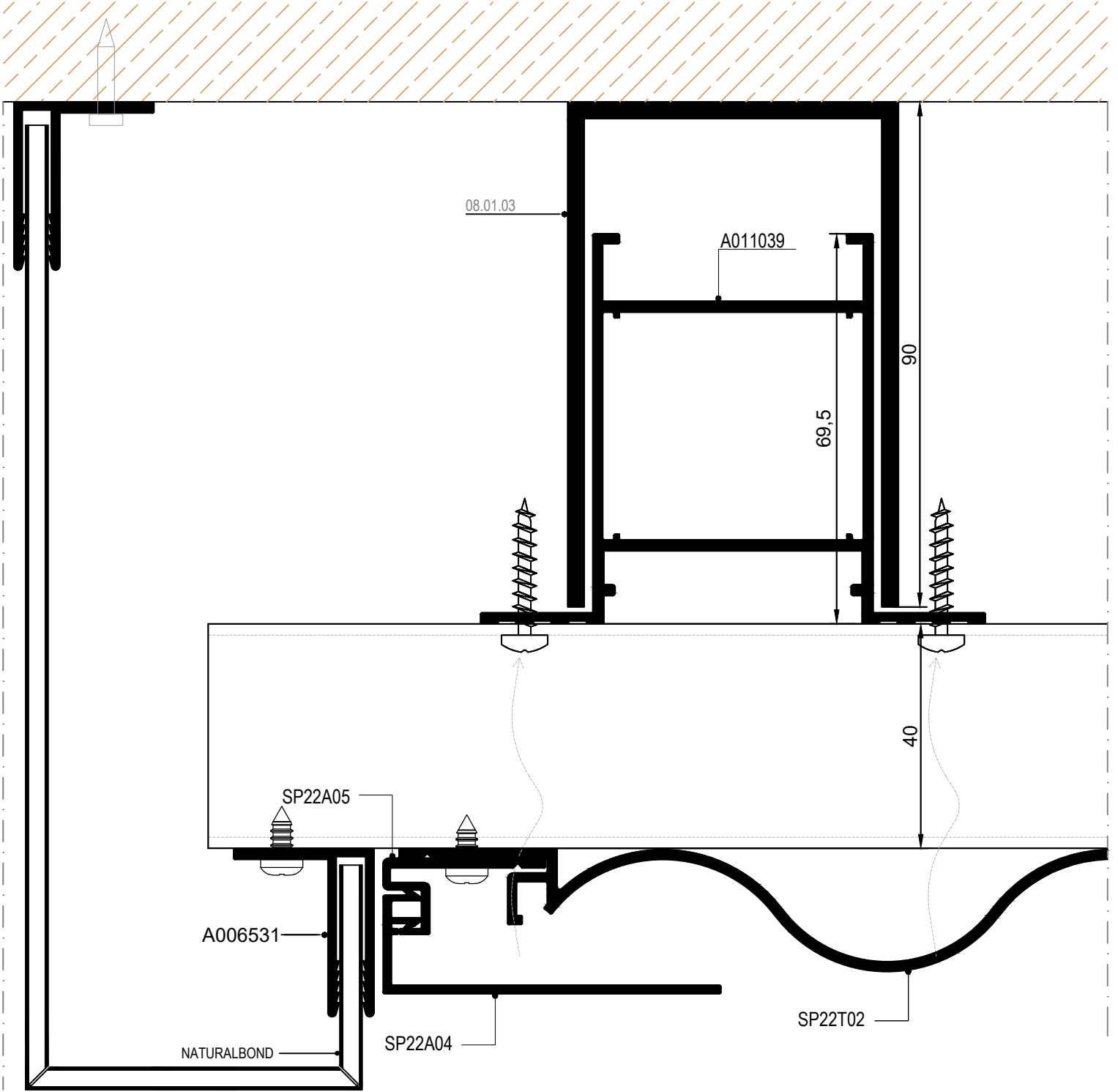

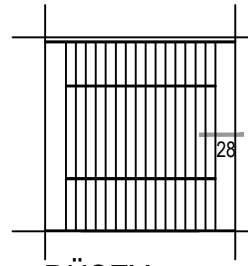

DÜŞEY
VERTICAL

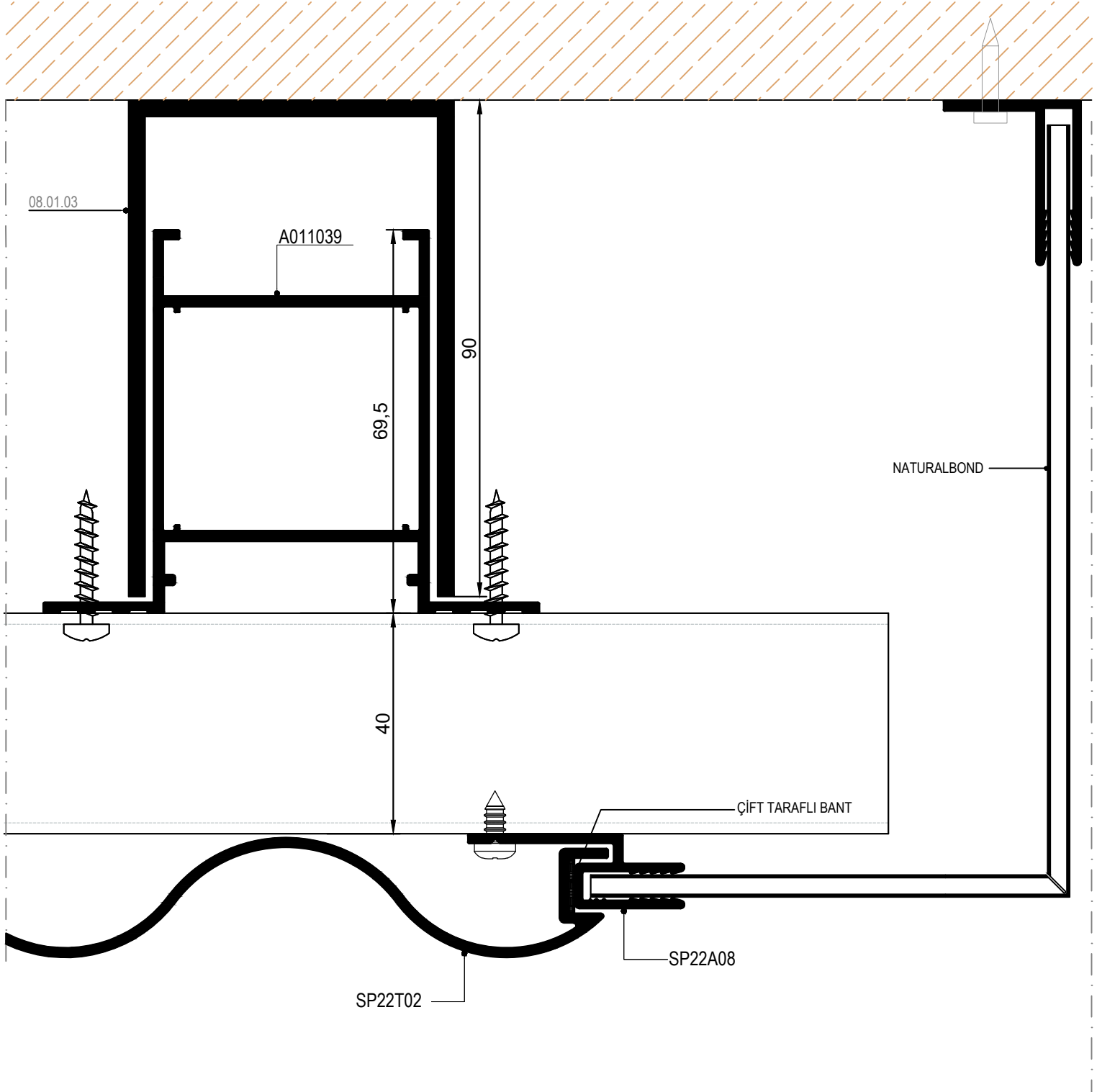

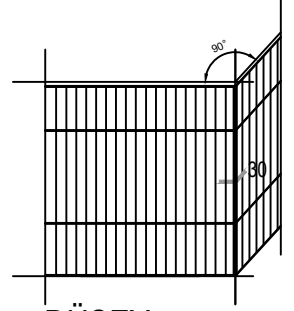

DÜŞEY
VERTICAL

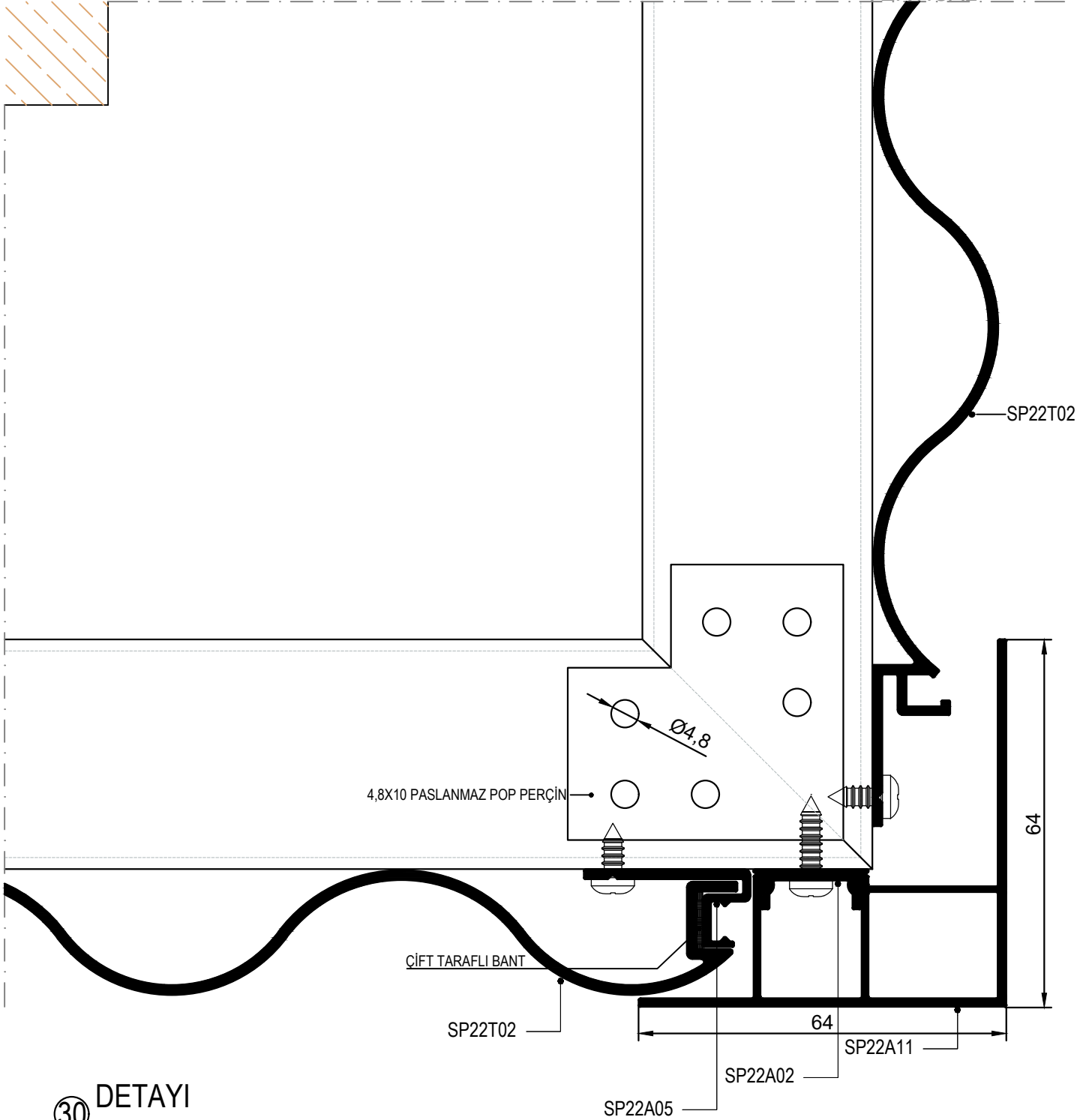

30 DETAYI
DETAIL

