

MİMARİ KATALOG ARCHITECTURAL CATALOGUE

Alüminyum Konvansiyonel Sistemleri
Aluminium Conventional Systems

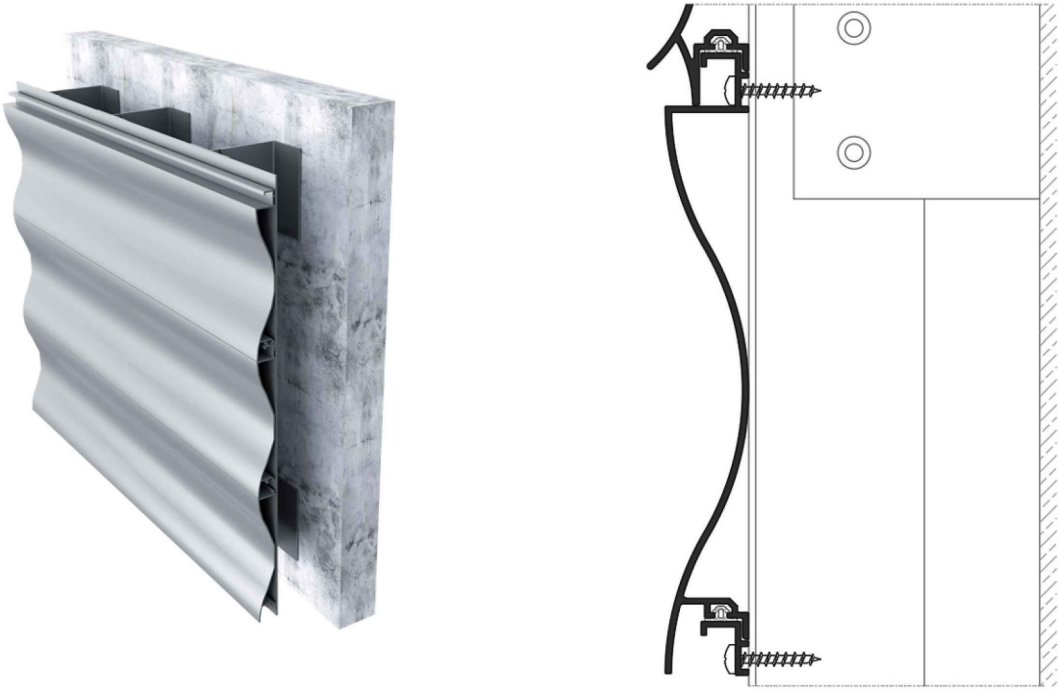

RDP



TEKNİK ÖZELLİKLERİ / TECHNICAL PROPERTIES

PROFİL GENİŞLİĞİ / PROFILE WIDTH	150/250 mm
PROFİL ET KALINLIĞI / PROFILE WALL THICKNESS	1,8 mm

KULLANIM SEÇENEKLERİ / APPLICATION ALTERNATIVES

CEPHE KAPLAMA SİSTEMİ / FACADE CLADDING SYSTEM	•
ALT KONSTRÜKSİYON SİSTEMİ / SUB-CONSTRUCTION SYSTEM	•
GEÇME KİLİT SİSTEMİ / FLIP-LOCK SYSTEM	•

MİMARİ KATALOG
ARCHITECTURAL CATALOGUE

Alüminyum Konvansiyonel Sistemleri
Aluminium Conventional Systems

RDP

PROFİLLER

PROFILES

KOD / CODE	AĞIRLIK (kg/m) / WEIGHT	Jxx cm4	Jyy cm4	L m	
DP01	1,369	----	----	6	
DP05	1,344	----	----	6	

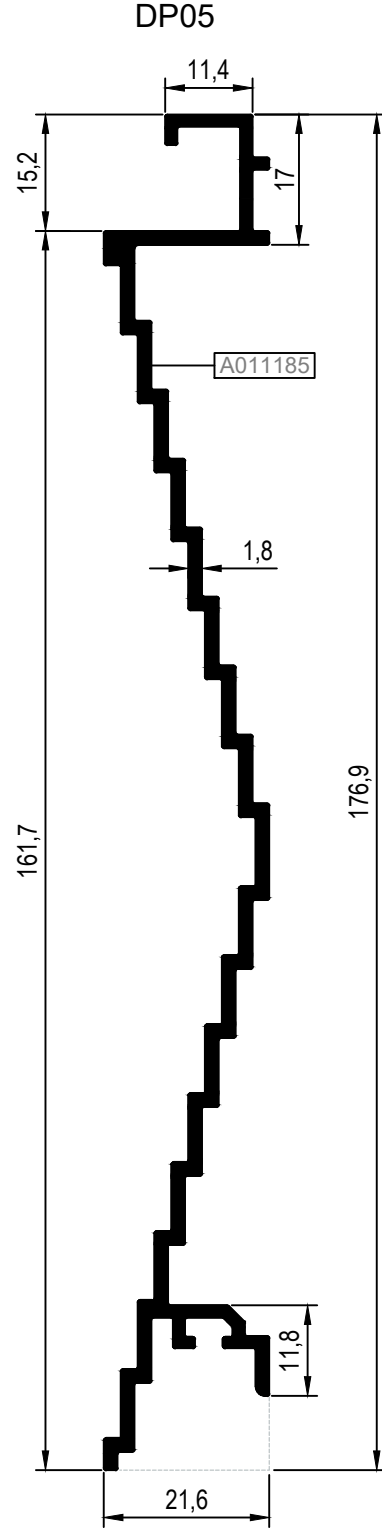
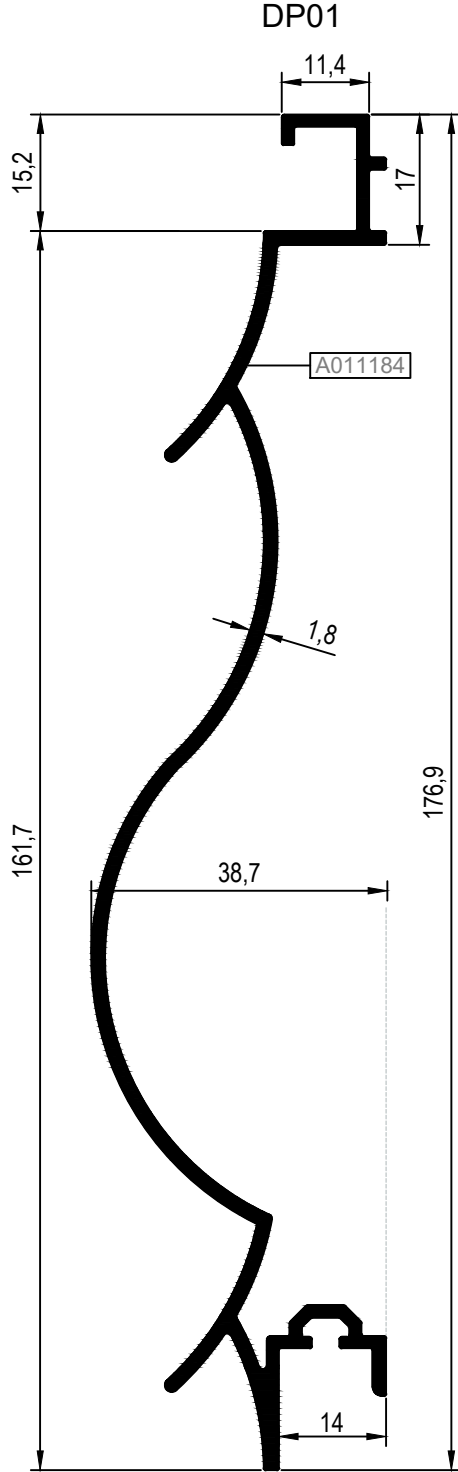

KOD / CODE	AĞIRLIK (kg/m) / WEIGHT	Jxx cm4	Jyy cm4	L m	
DP06	1,218	----	----	6	
DP07	1,193	----	----	6	

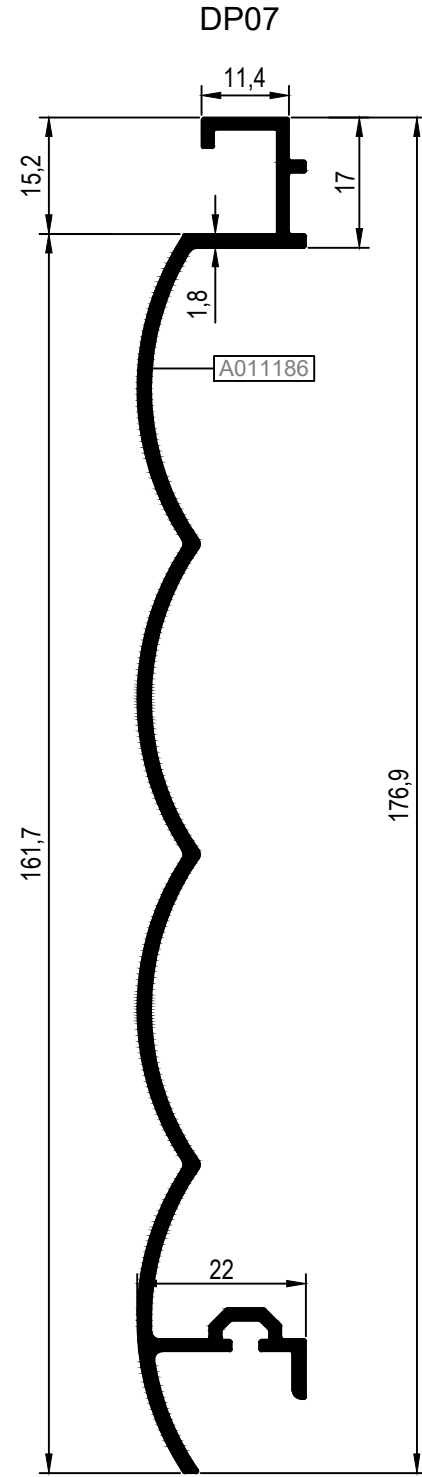
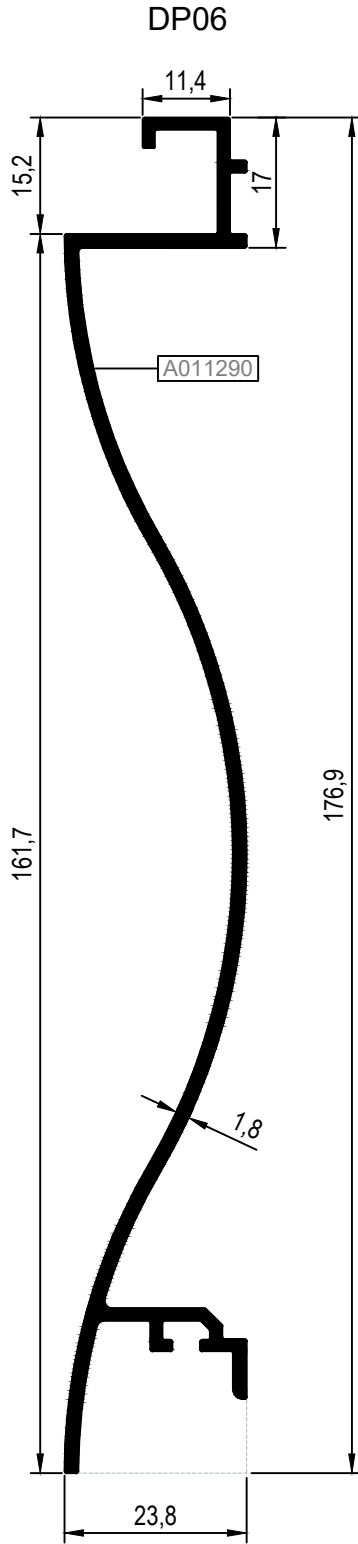

KOD / CODE	AĞIRLIK (kg/m) / WEIGHT	Jxx cm4	Jyy cm4	L m	
DP10	1,253	----	----	6	
DP11	1,172	----	----	6	

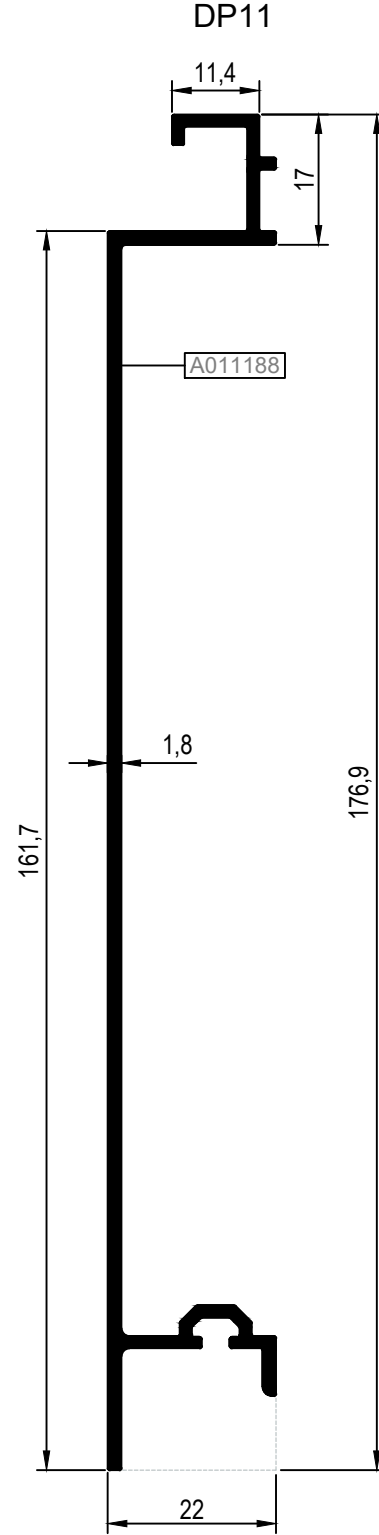
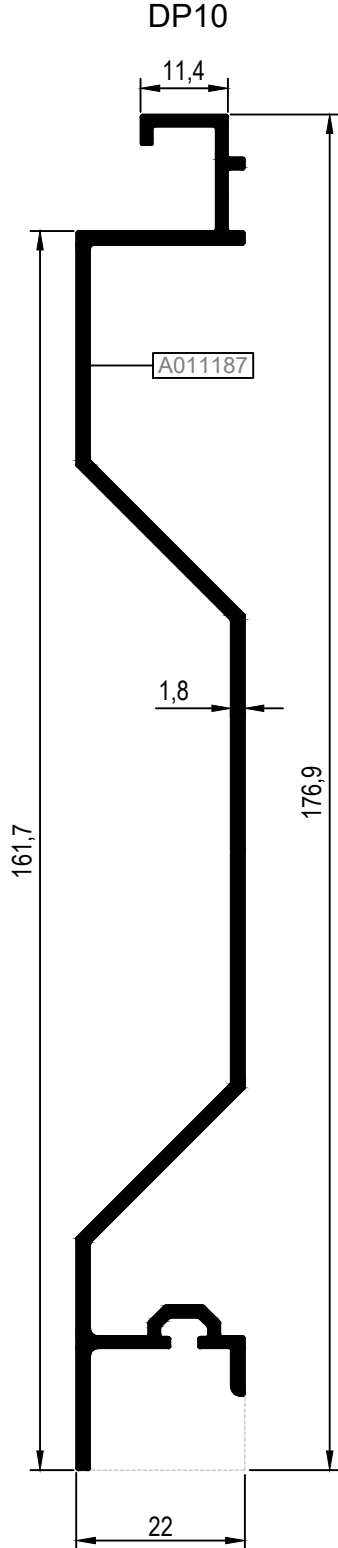

KOD / CODE	AĞIRLIK (kg/m) / WEIGHT	Jxx cm4	Jyy cm4	L m	
A011182	0,665	7,703	5,479	6	
A011183	0,955	----	----	6	
DP13	0,141	----	----	6	

A011182

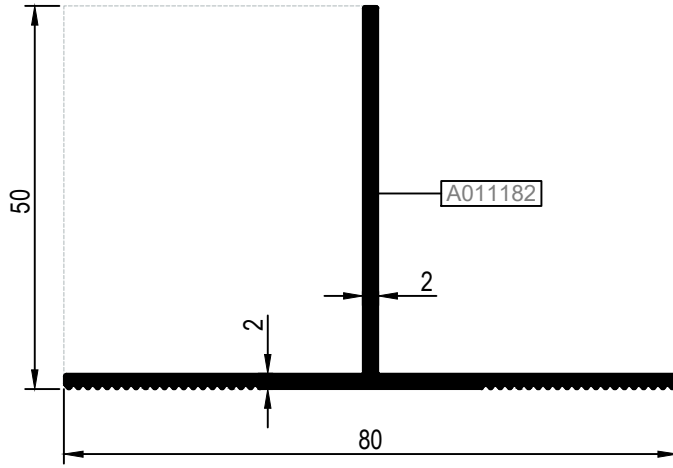

A011183

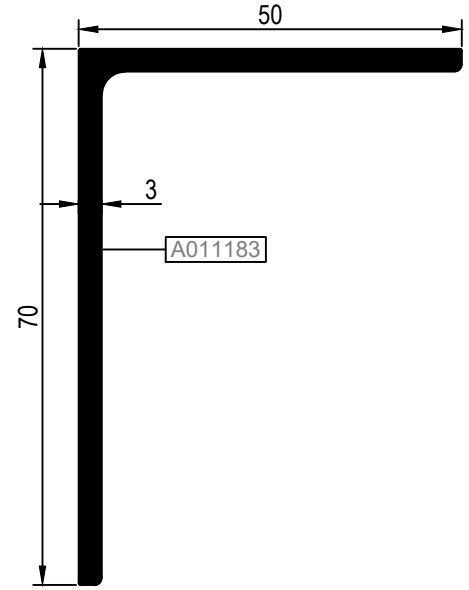

DP13

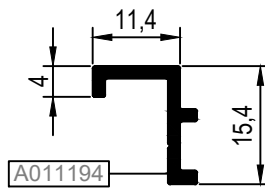

MİMARİ KATALOG
ARCHITECTURAL CATALOGUE

Alüminyum Konvansiyonel Sistemleri
Aluminium Conventional Systems

RDP

DETAYLAR

DETAILS

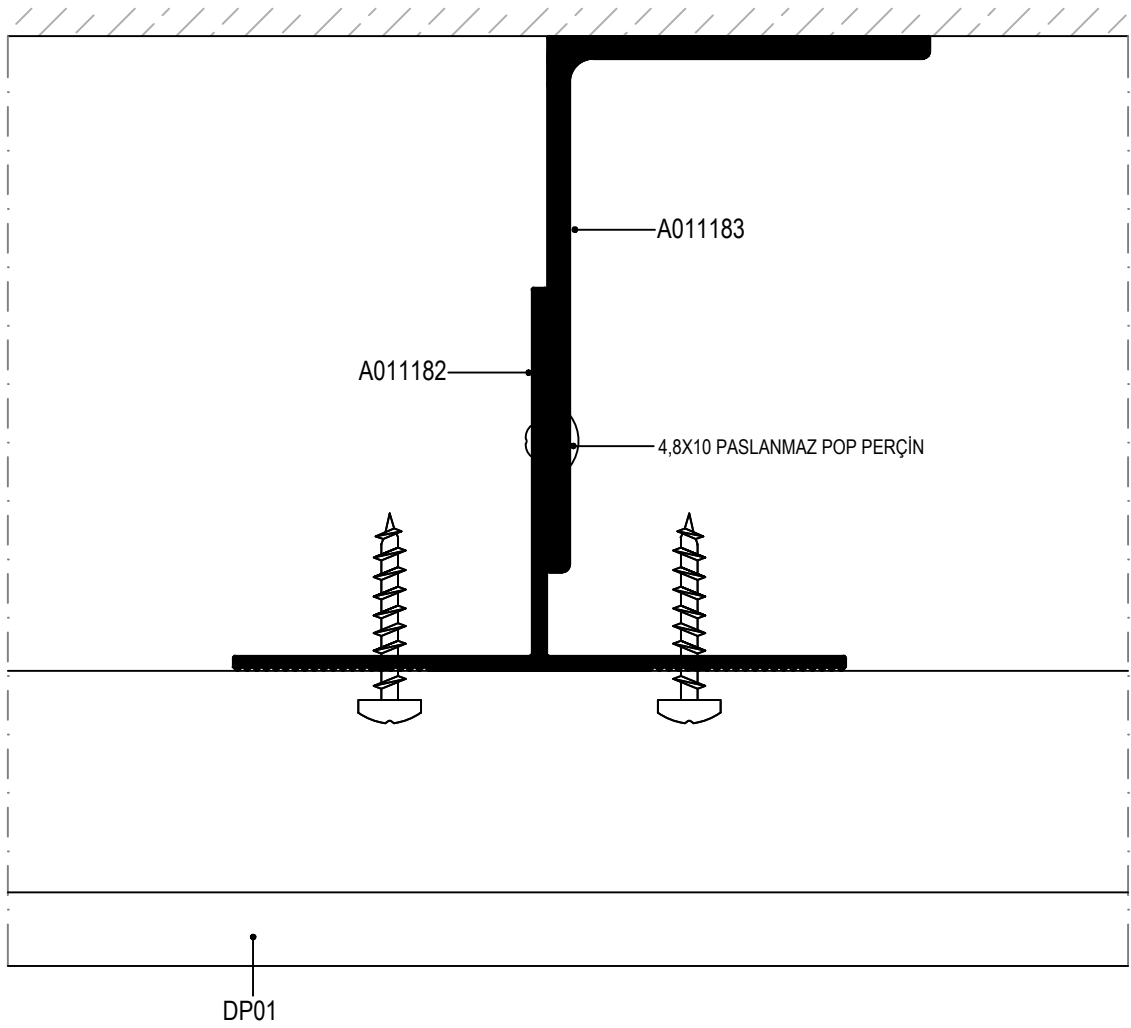

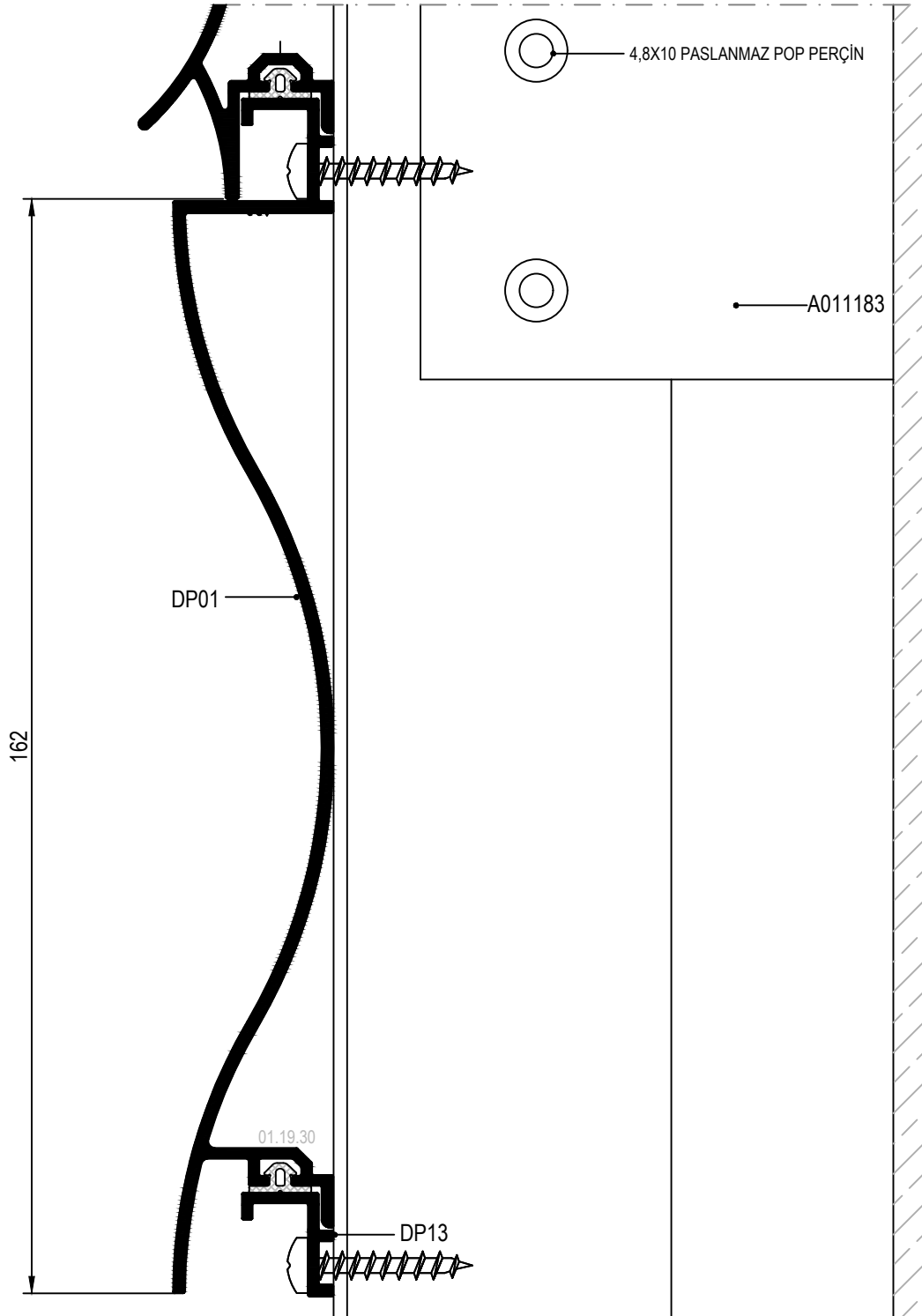

MİMARİ KATALOG
ARCHITECTURAL CATALOGUE

Alüminyum Konvansiyonel Sistemleri
Aluminium Conventional Systems

RDP

AKSESUARLAR

ACCESSORIES

	<p>01.19.30</p> <p>BİNİ FİTİLİ GASKET</p> <p>Malzeme / Material : EPDM Ağırlık / Weight : 27 gr/m Paket / Package: 555 m / 15 kg</p>	