

MİMARİ KATALOG
ARCHITECTURAL CATALOGUE

Alüminyum Konvansiyonel Sistemleri
Aluminium Conventional Systems

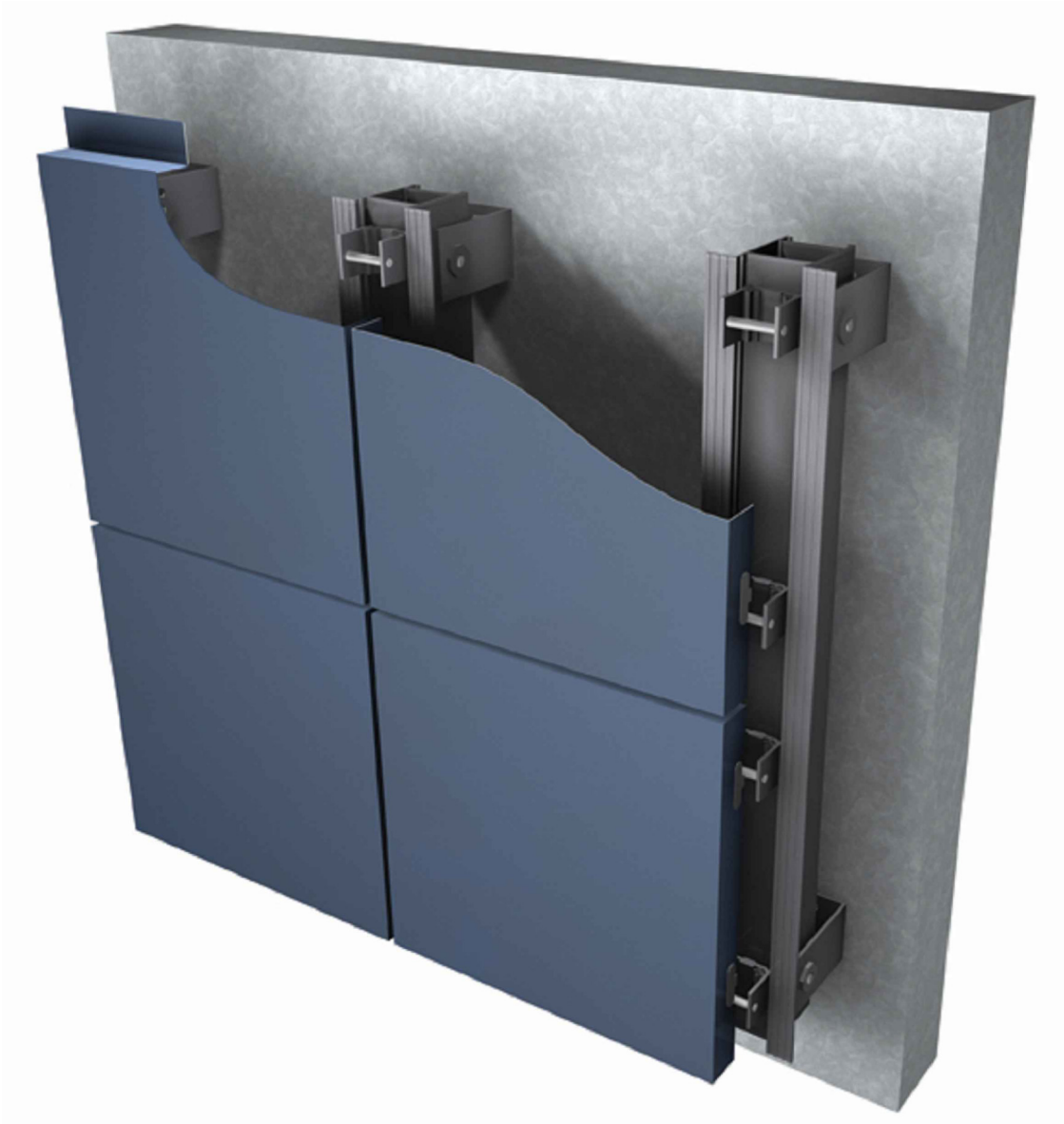

COMP 50

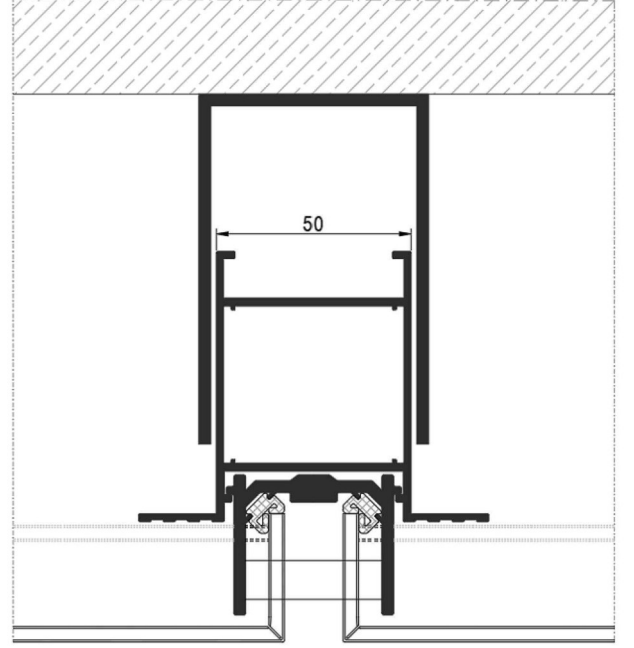

TEKNİK ÖZELLİKLERİ / TECHNICAL PROPERTIES

PROFİL GENİŞLİĞİ / PROFILE WIDTH	90 mm
PROFİL ET KALINLIĞI / PROFILE WALL THICKNESS	1,8/2 mm
KOMPOZİT LEVHA KALINLIĞI/ COMPOSITE PANEL WALL THICKNESS	4 mm

KULLANIM SEÇENEKLERİ / APPLICATION ALTERNATIVES

KOMPOZİT CEPHE SİSTEMİ / COMPOSITE FACADE SYSTEM	•
---	---

MİMARİ KATALOG
ARCHITECTURAL CATALOGUE

Alüminyum Konvansiyonel Sistemleri
Aluminium Conventional Systems

COMP50

PROFİLLER

PROFILES

KOD / CODE	AĞIRLIK (kg/m) / WEIGHT	Jxx cm ⁴	Jyy cm ⁴	L m	
A010634	1,271	10,261	24,261	6	
A011039	1,447	27,917	28,126	6	

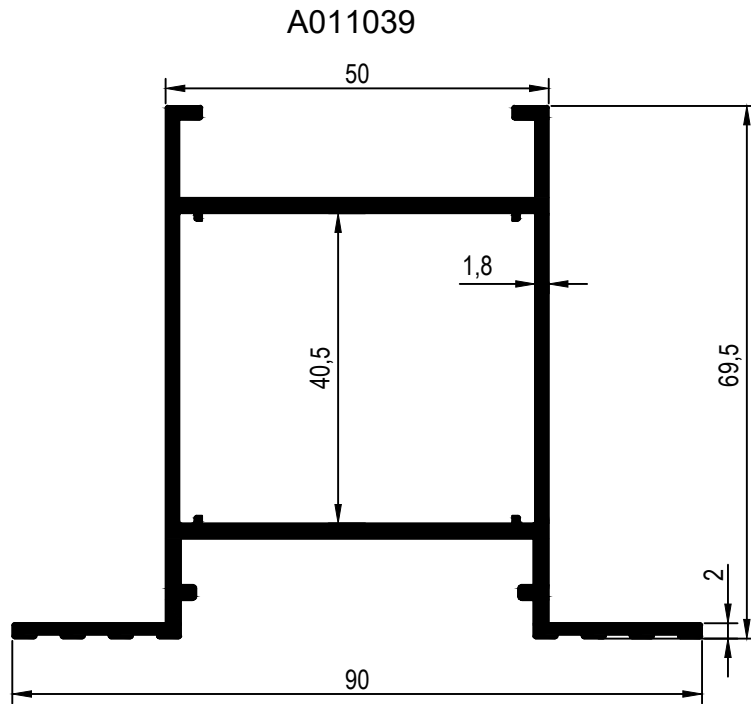
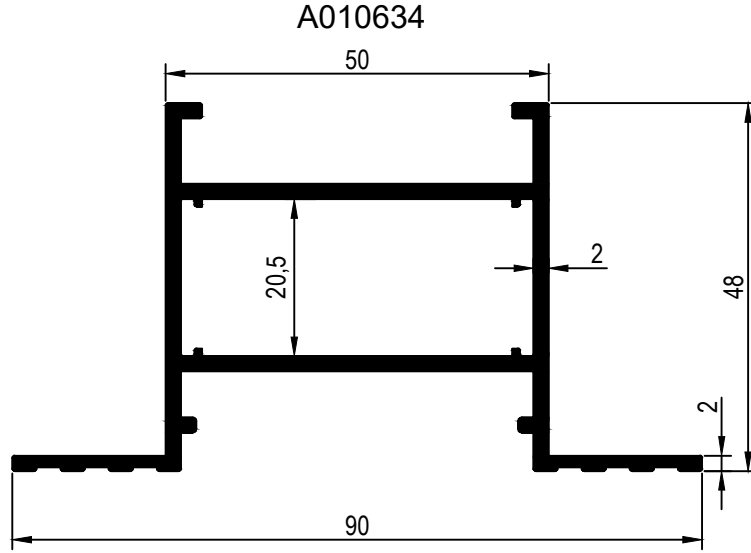

KOD / CODE	AĞIRLIK (kg/m) / WEIGHT	L m	KOD / CODE	AĞIRLIK (kg/m) / WEIGHT	L m
A006531	0,368	6	A003561	0,199	6
A001100	0,224	6	A011191	0,295	6
A003558	0,238	6	A011484	0,168	6
A006773	0,222	6	A011485	0,335	6
A000257	0,335	6			

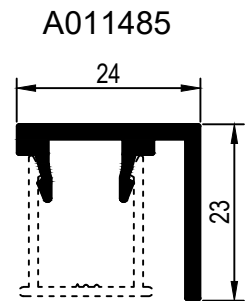
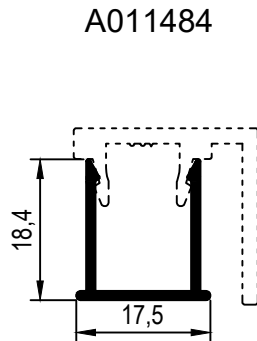
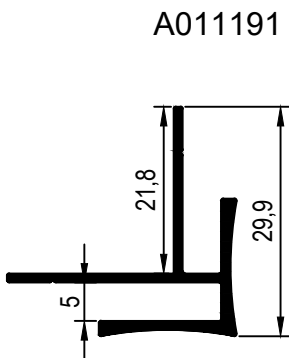
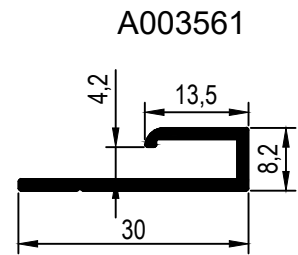
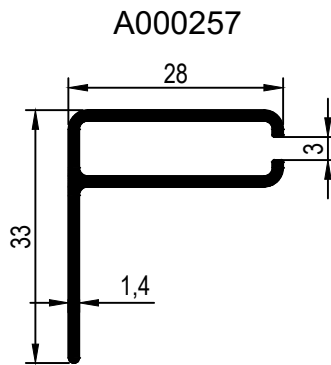
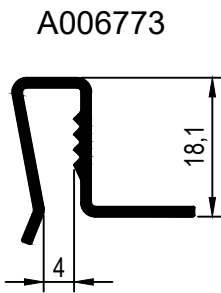
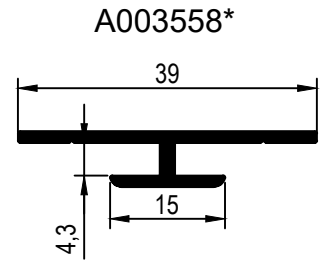
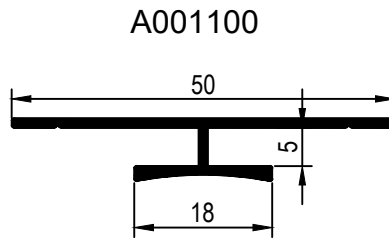
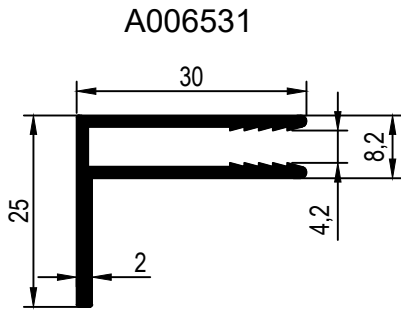
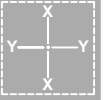

KOD / CODE	AĞIRLIK (kg/m) / WEIGHT	Jxx cm4	Jyy cm4	L m	
A011898	0,259	0,096	0,886	6	
A011997	0,153	0,059	0,139	6	
A015835	0,303	0,609	0,608	6	
A015836	0,295	0,444	0,444	6	
A015833	0,391	0,169	4,599	6	

A011898

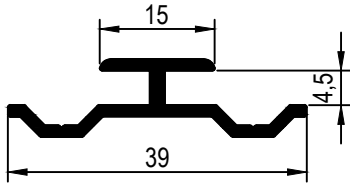

A015833

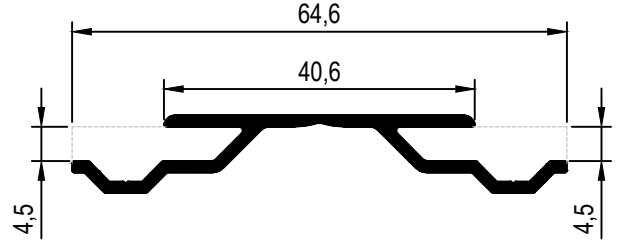

A011997

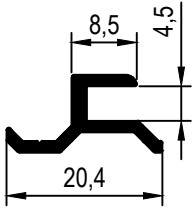

A015835

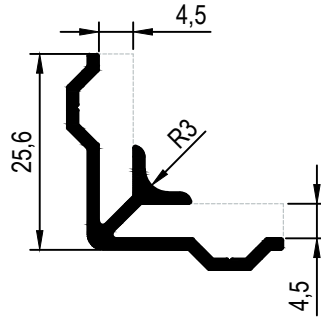

A015836

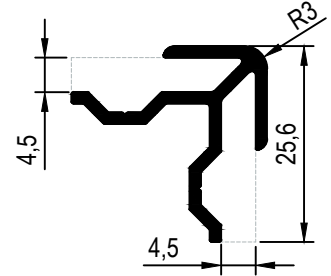

MİMARİ KATALOG
ARCHITECTURAL CATALOGUE

Alüminyum Konvansiyonel Sistemleri
Aluminium Conventional Systems

COMP50

DETAYLAR

DETAILS

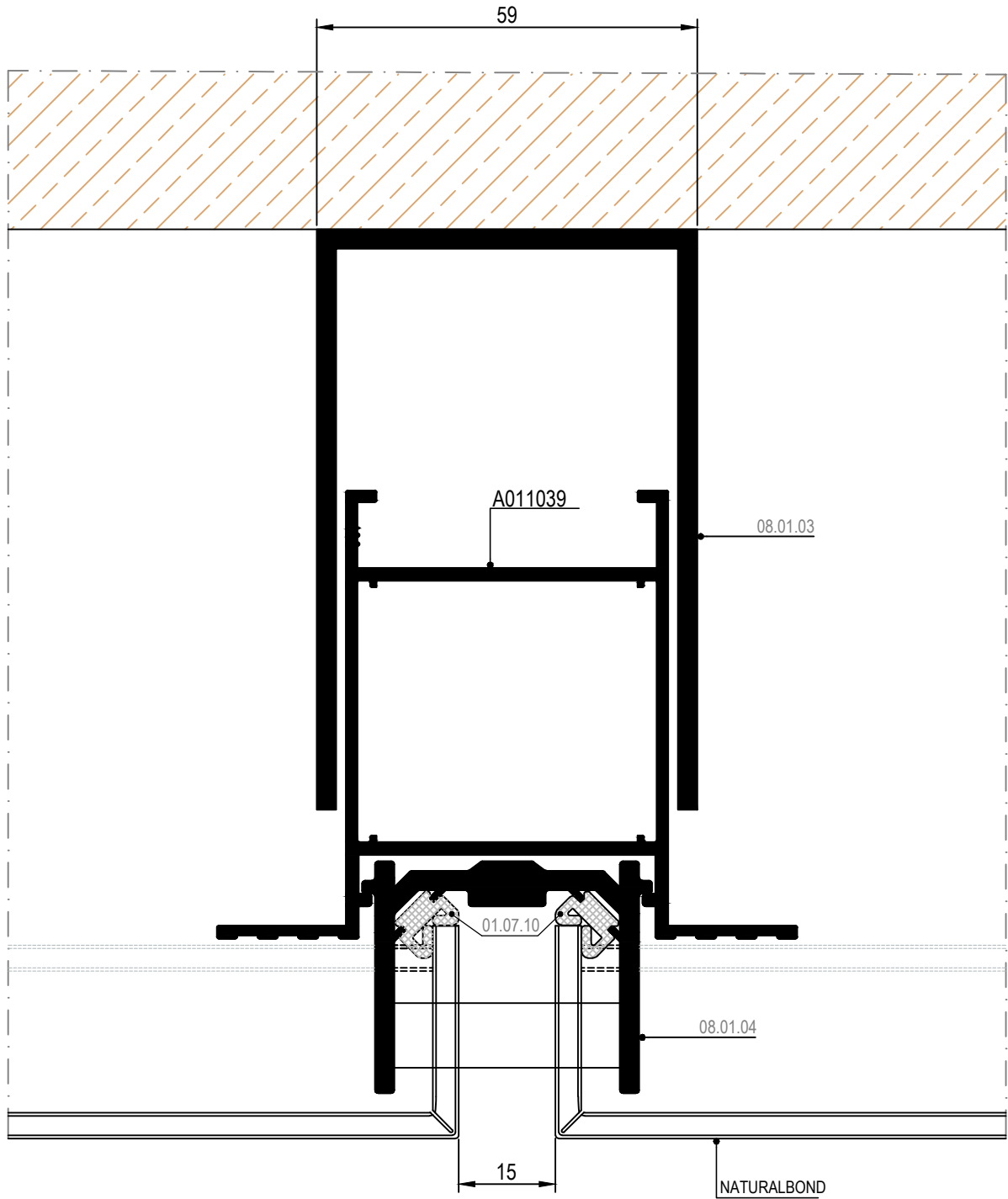

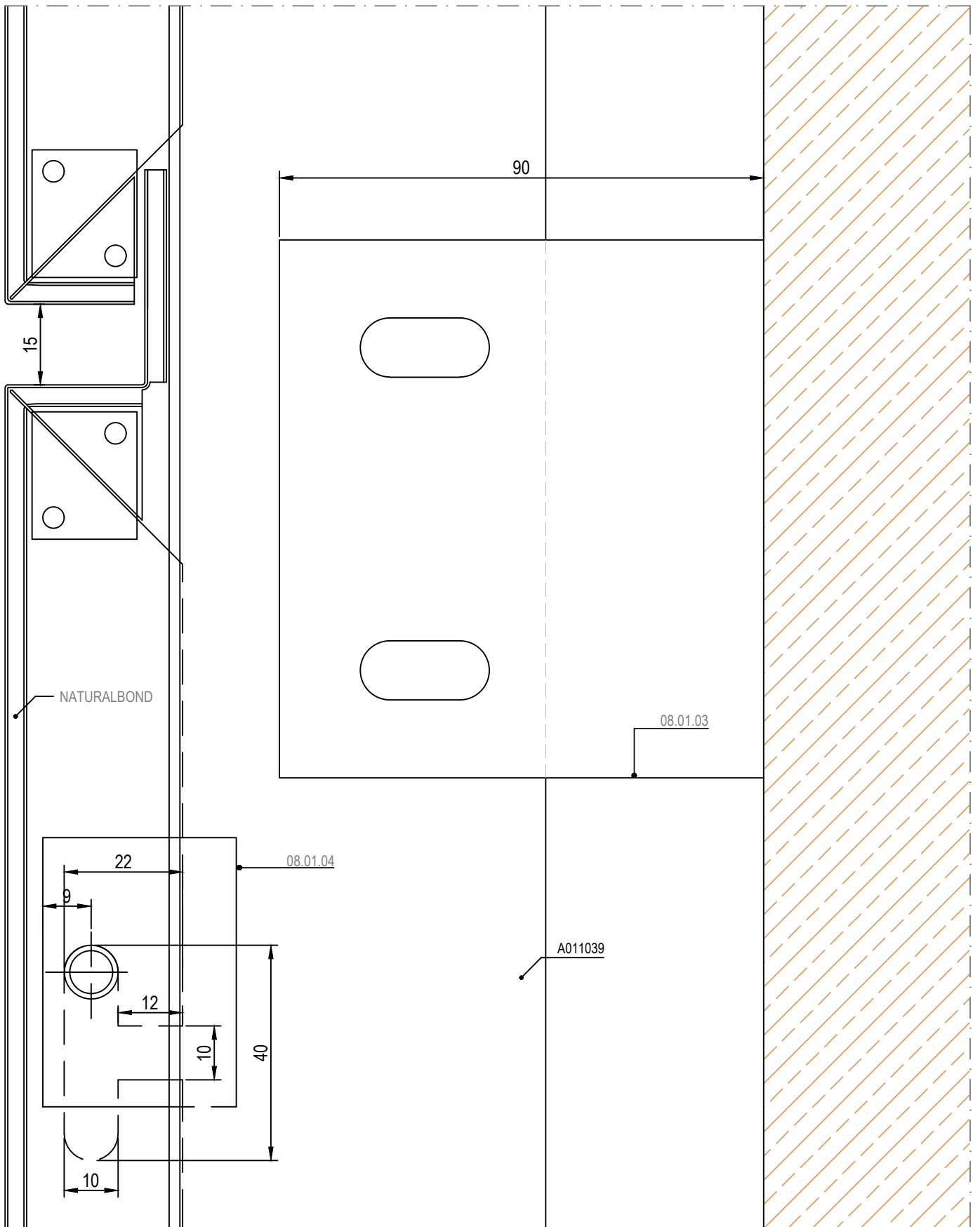

MİMARİ KATALOG
ARCHITECTURAL CATALOGUE

Alüminyum Konvansiyonel Sistemleri
Aluminium Conventional Systems

COMP50

AKSESUARLAR

ACCESSORIES

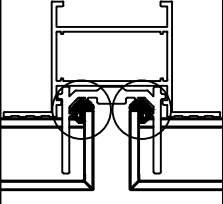
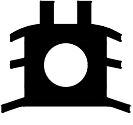
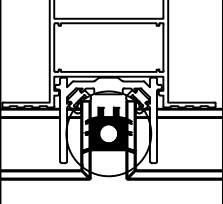
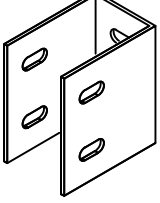
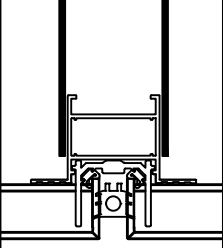
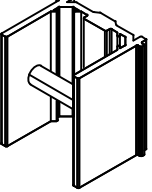
	01.07.10 FİTİL GASKET Malzeme / Material : EPDM Ağırlık / Weight : 72 gr/m Paket / Package: 208,3 m / 15 kg				
	01.07.14 DERZ FİTİLİ LINE GASKET Malzeme / Material : EPDM Ağırlık / Weight : 225 gr/m Paket / Package: 65 m / 15 kg				
	08.01.03 ALÜMİNYUM ANKRAJ ANCHORAGE (ALUMINIUM) Profil No: A010635				
	08.01.04 ANAHTAR GEÇME BAĞLANTI (50MM) CONNECTION PIECE (50MM) Profil No: A010633	