

MİMARİ KATALOG ARCHITECTURAL CATALOGUE

Alüminyum Konvansiyonel Sistemleri
Aluminium Conventional Systems

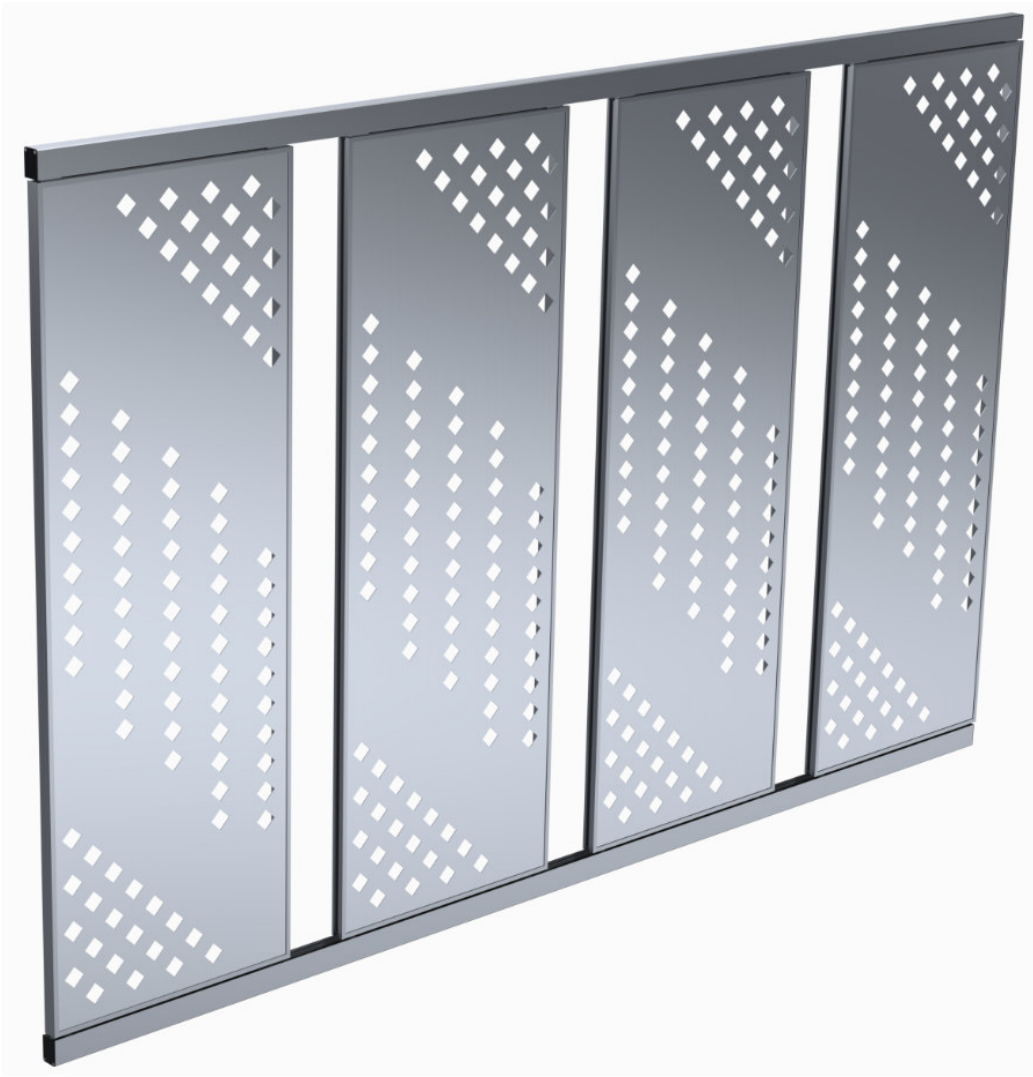

SN42

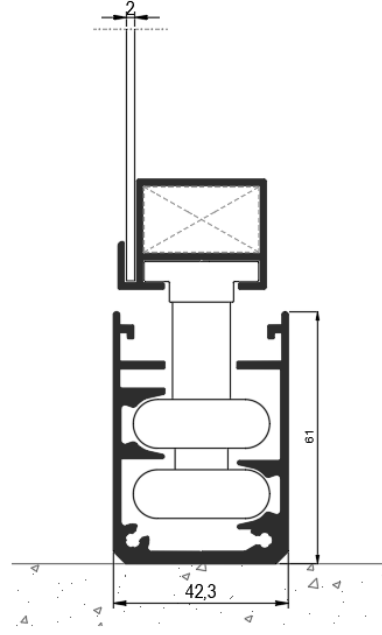
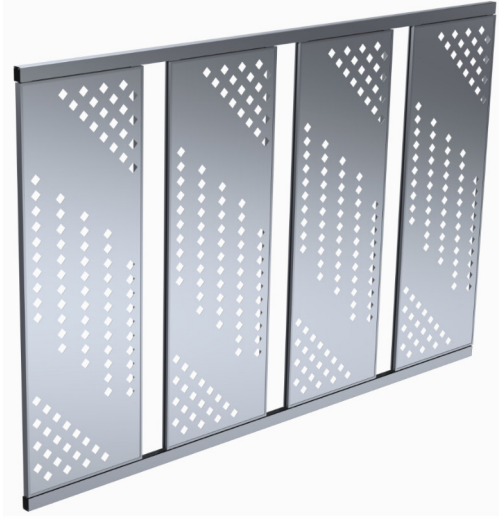

TEKNİK ÖZELLİKLERİ / TECHNICAL PROPERTIES

KASA DERİNLİĞİ / FRAME DEPTH	61 mm
KANAT DERİNLİĞİ / VENT DEPTH	31,3 mm
PROFİL ET KALINLIĞI / PROFILE WALL THICKNESS	1,5 / 1,8 mm
LEVHA KALINLIĞI / SHEET THICKNESS	2 mm

MİMARİ KATALOG
ARCHITECTURAL CATALOGUE

Alüminyum Konvansiyonel Sistemleri
Aluminium Conventional Systems

SN42

PROFİLLER

PROFILES

KOD / CODE	AĞIRLIK (kg/m) / WEIGHT	Jxx cm ⁴	Jyy cm ⁴	L m	
SN42F01	1,438	15,071	19,328	6	
SN42F02	1,767	28,153	23,802	6	
SN42V01	0,535	1,689	3,227	6	
SN42V02	0,531	1,667	3,126	6	
SN42M01	0,430	0,518	1,540	6	
SN42A01	0,089	----	----	6	

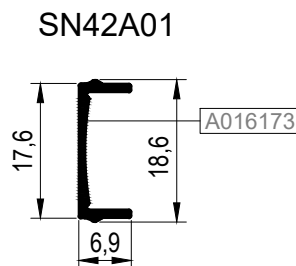
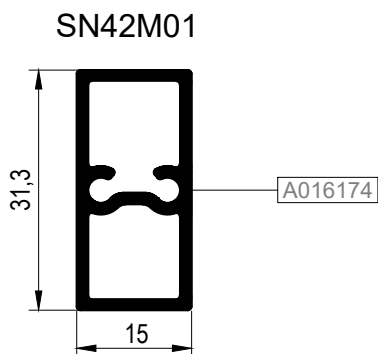
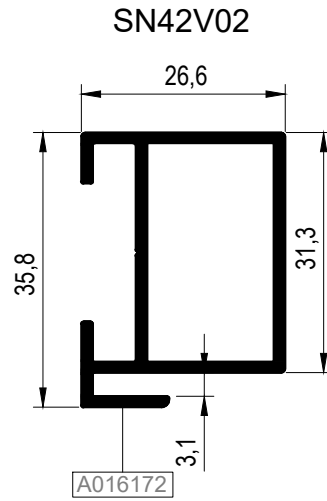
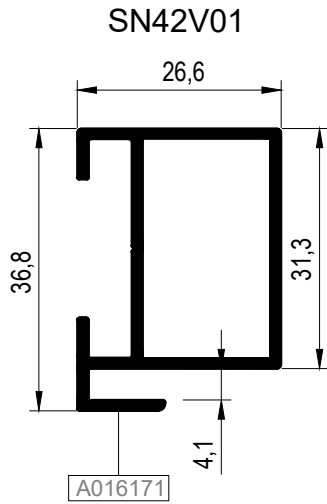
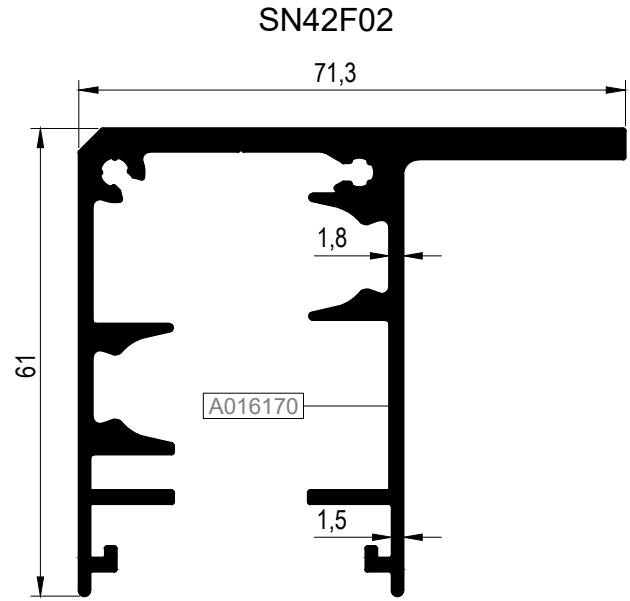
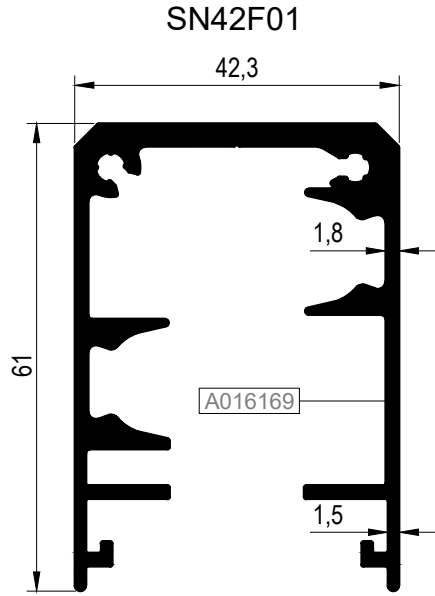

MİMARİ KATALOG
ARCHITECTURAL CATALOGUE

Alüminyum Konvansiyonel Sistemleri
Aluminium Conventional Systems

SN42

DETAYLAR

DETAILS

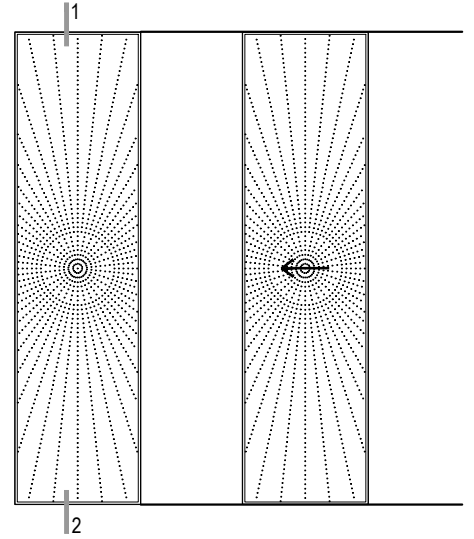
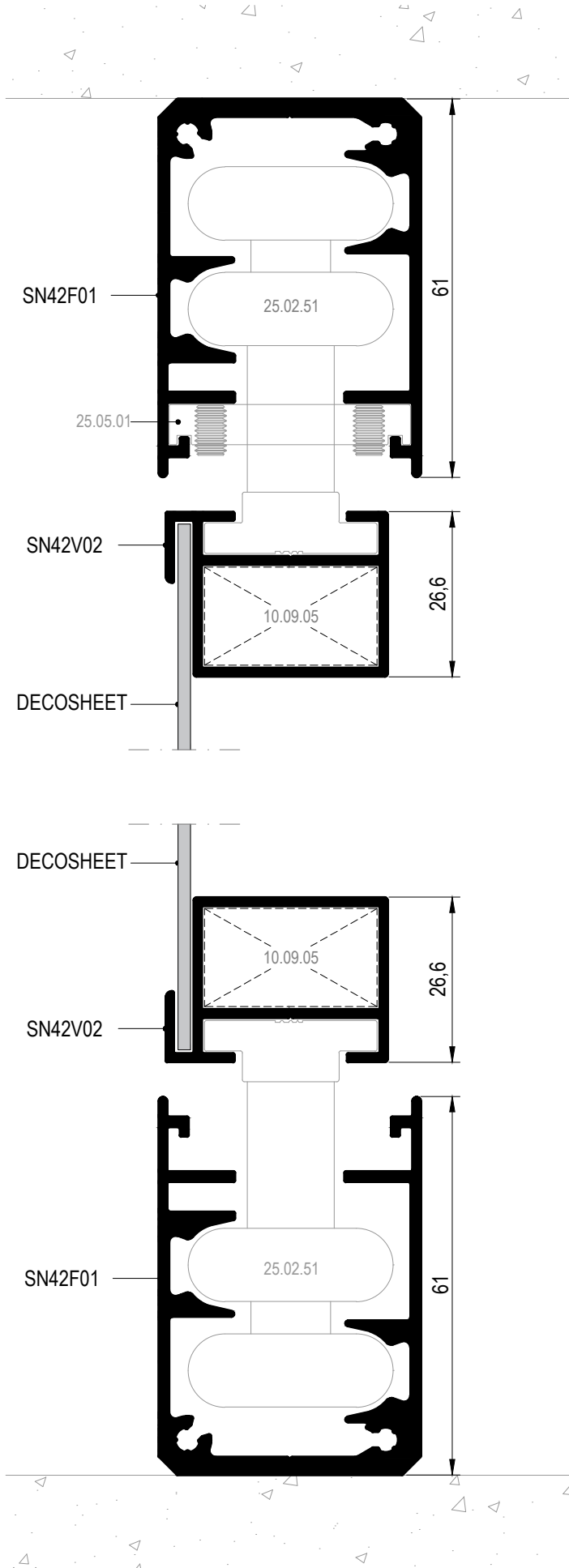

① DETAYI
DETAIL

② DETAYI
DETAIL

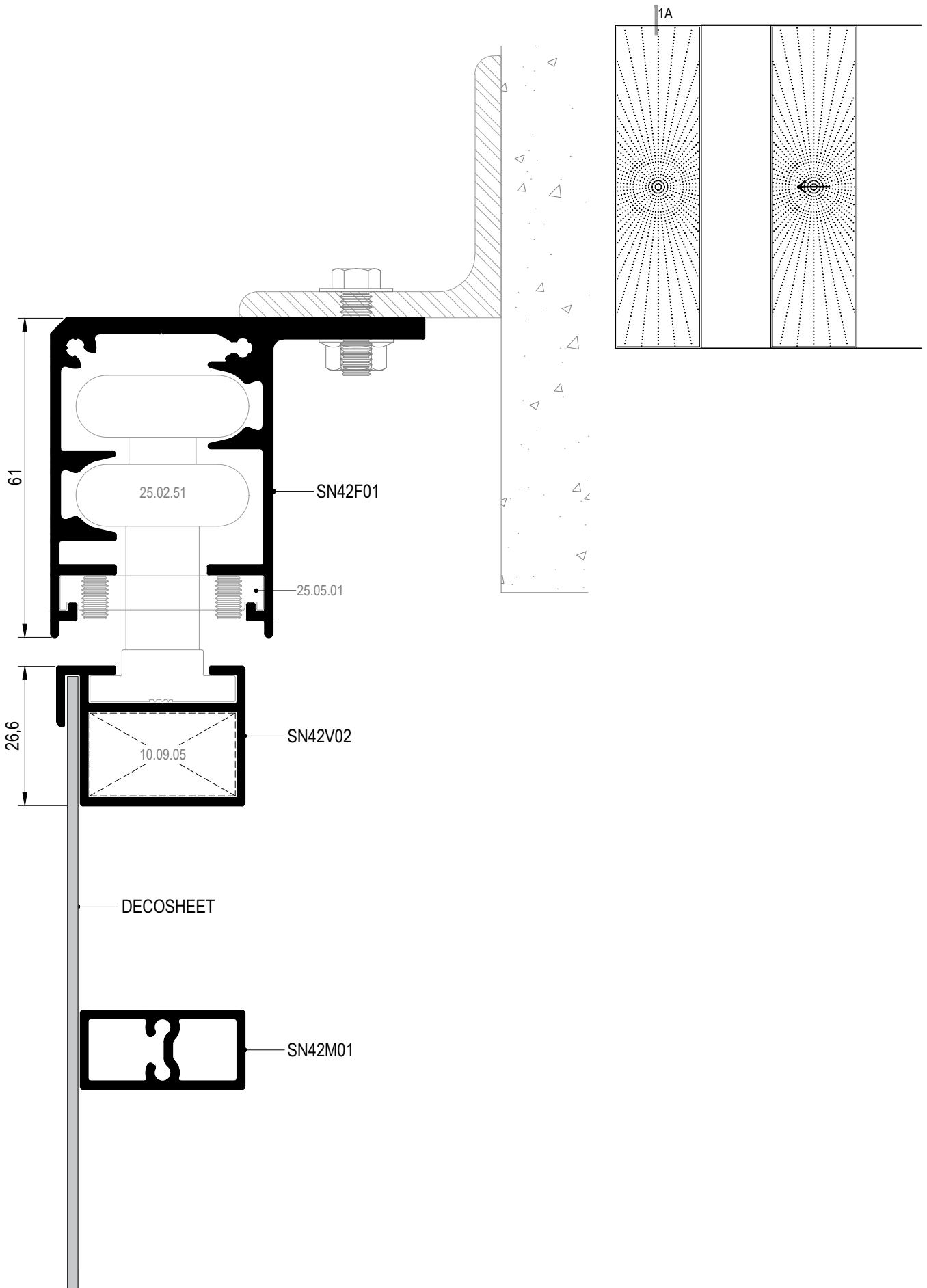

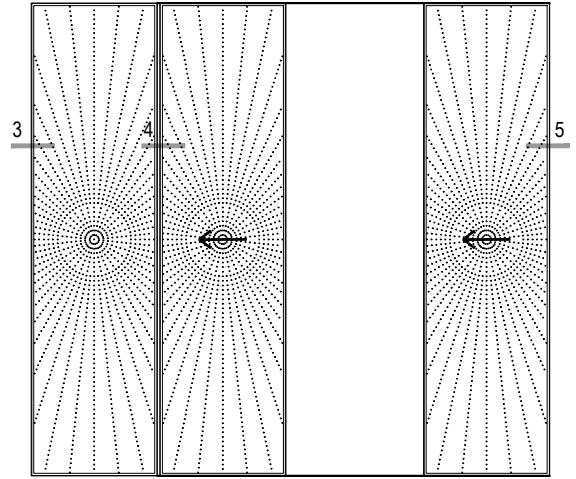
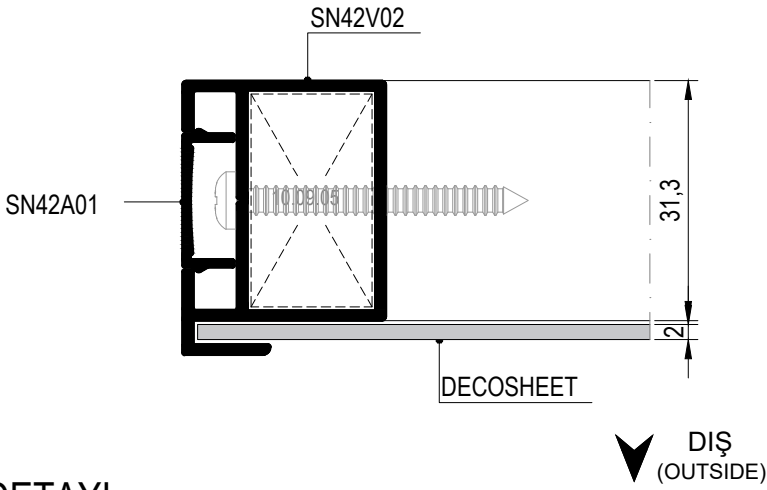

③ DETAYI
DETAIL

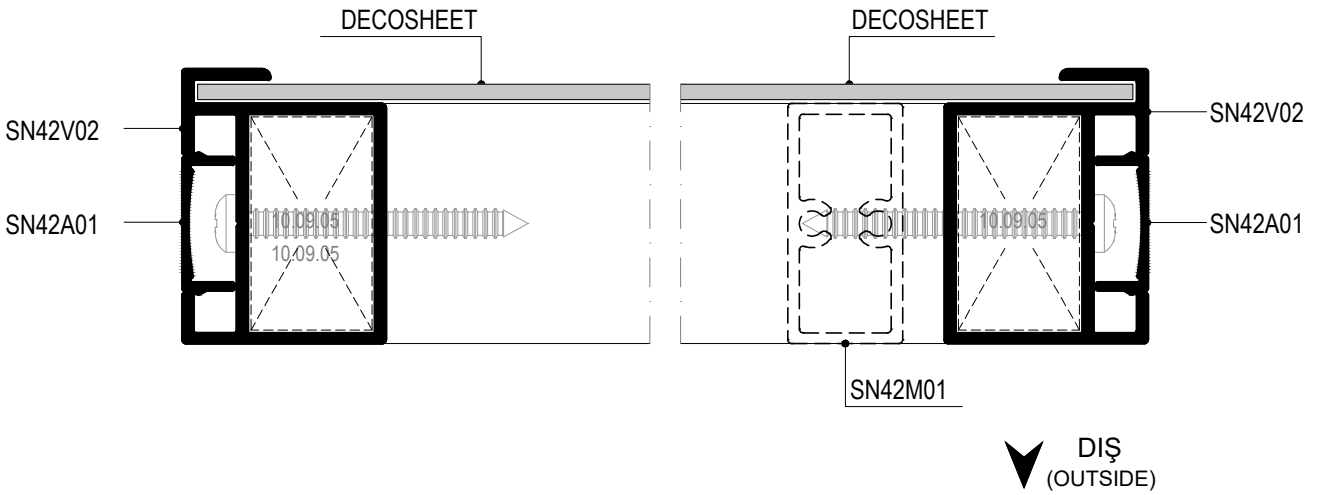

④ DETAYI
DETAIL

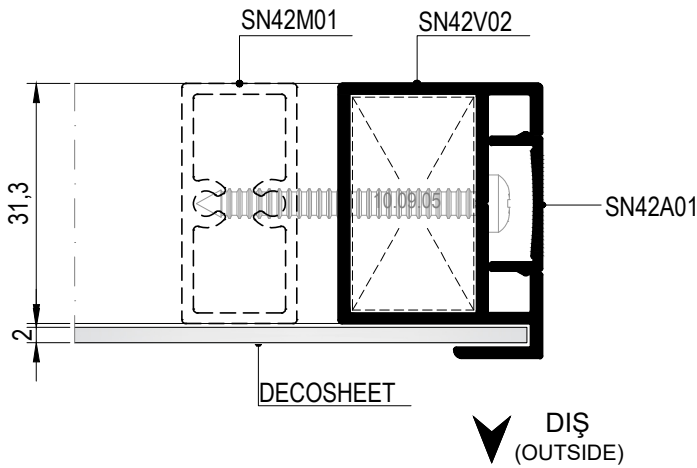

⑤ DETAYI
DETAIL

MİMARİ KATALOG
ARCHITECTURAL CATALOGUE

Alüminyum Konvansiyonel Sistemleri
Aluminium Conventional Systems

SN42

AKSESUARLAR

ACCESSORIES



25.02.51

RULMAN
ROLLER

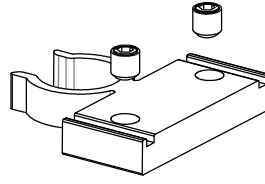

25.05.01

STOPER
STOPER

Malzeme / Material : PVC

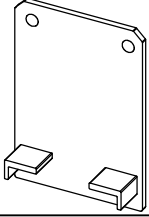

25.05.02

KAPAK
CAP

Malzeme / Material : PVC

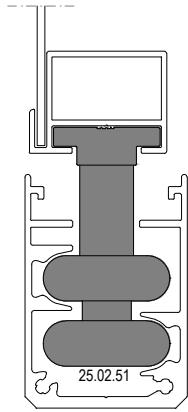

Ölçek/Scale: ½

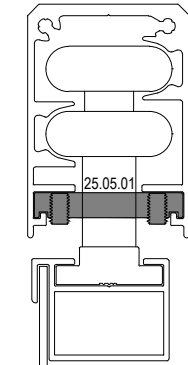

Ölçek/Scale: ½

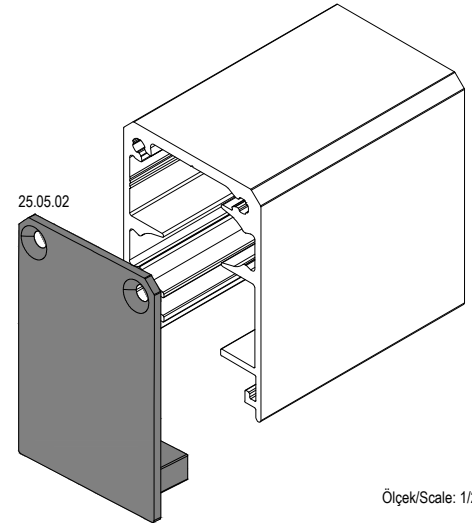

Ölçek/Scale: 1/2