

MİMARİ KATALOG
ARCHITECTURAL CATALOGUE

Alüminyum Konvansiyonel Sistemleri
Aluminium Conventional Systems

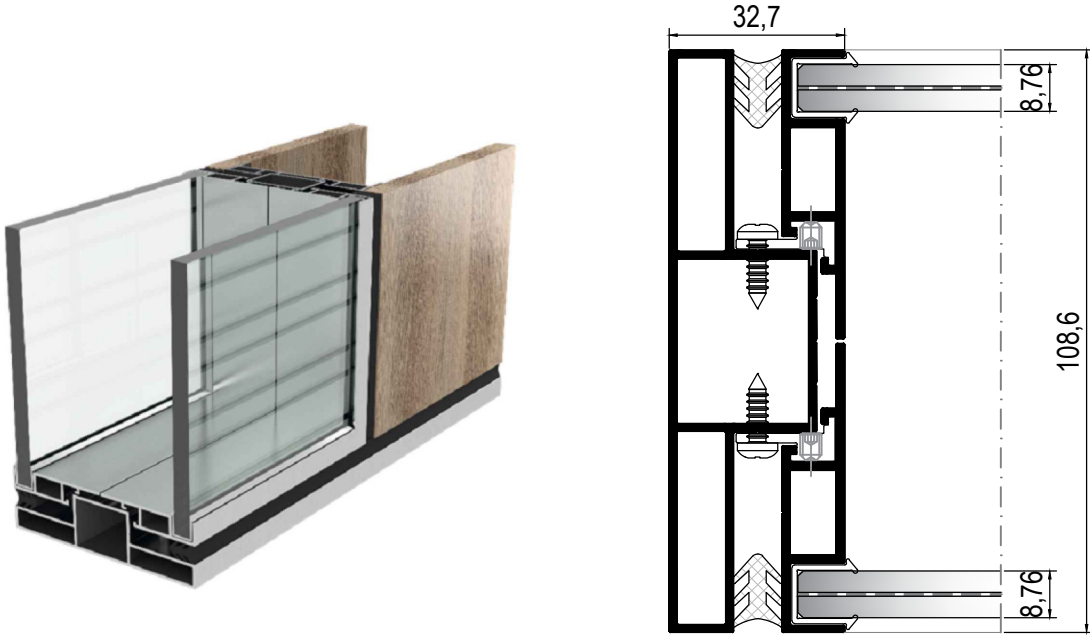

RO108



TEKNİK ÖZELLİKLERİ / TECHNICAL PROPERTIES

KASA DERİNLİĞİ / FRAME DEPTH	108,6 mm
SİSTEM GÖRÜNÜR YÜZEY GENİŞLİĞİ / VISIBLE SURFACE WIDTH	32,7 mm
CAM KALINLIKLARI / GLASS THICKNESS	6 / 8 / 8,76 mm

KULLANIM SEÇENEKLERİ / APPLICATION ALTERNATIVES

ÇİFT CAMLI OFİS BÖLME SİSTEMİ / DOUBLE GLAZED OFFICE PARTITION SYSTEM
AHŞAP KAPI ÇERÇEVE PROFİLİ ALTERNATİFİ / WOOD DOOR FRAME PROFILE ALTERNATIVE
ÇERÇEVELİ VE ÇERÇEVESİZ BİNİLİ KAPI / FRAMED AND UNFRAMED DOOR
T KÖŞE BİRLEŞİM / T CORNER CONNECTION
Y KÖŞE BİRLEŞİM / Y CORNER CONNECTION
90° KÖŞE DÖNÜŞ / 90° CORNER TURN
120° KÖŞE DÖNÜŞ / 120° CORNER TURN
176° KÖŞE DÖNÜŞ / 176° CORNER TURN
KABLO KANALI ALTERNATİFİ / CABLE CHANNEL ALTERNATIVE
DEKORATİF KASET PROFİLİ / DECORATIVE CASSETTE PROFILE
ÇİFT CAM ARASI JALUZİ ALTERNATİFİ / BLIND ALTERNATIVE IN-BETWEEN DOUBLE GLAZING

MİMARİ KATALOG
ARCHITECTURAL CATALOGUE

Alüminyum Konvansiyonel Sistemleri
Aluminium Conventional Systems

RO108

PROFİLLER

PROFILES

KOD / CODE	AĞIRLIK (kg/m) / WEIGHT	Jxx cm ⁴	Jyy cm ⁴	L m	
RO108F01	1,171	3,404	41,827	6	
RO108F02	0,706	8,405	2,512	6	
RO108F04	1,328	49,154	2,381	6	

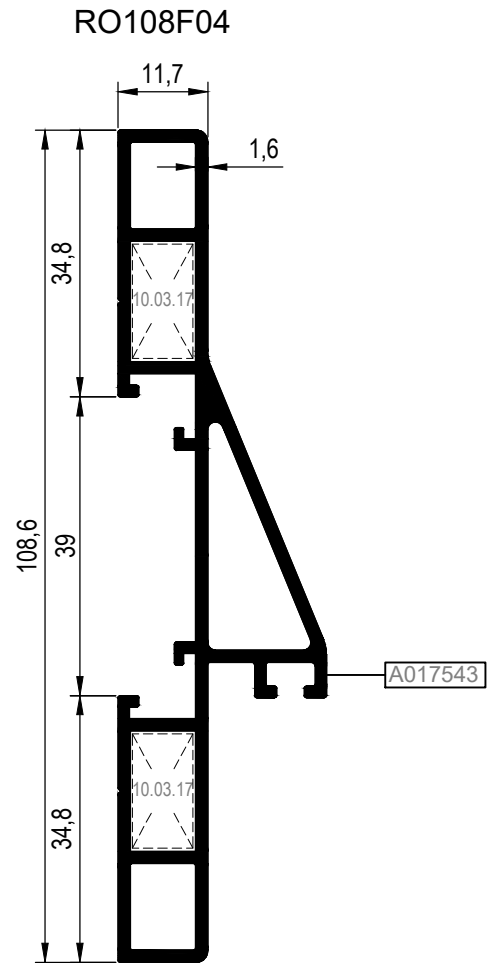
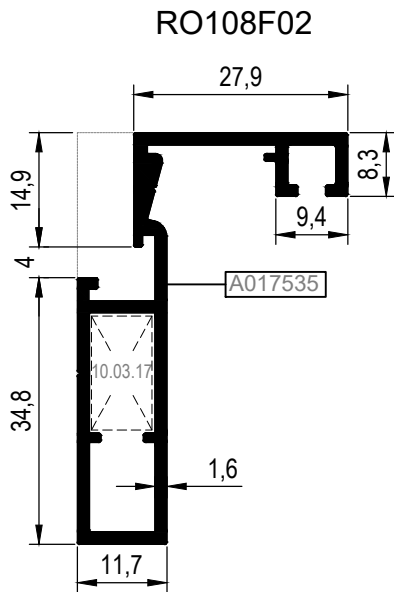
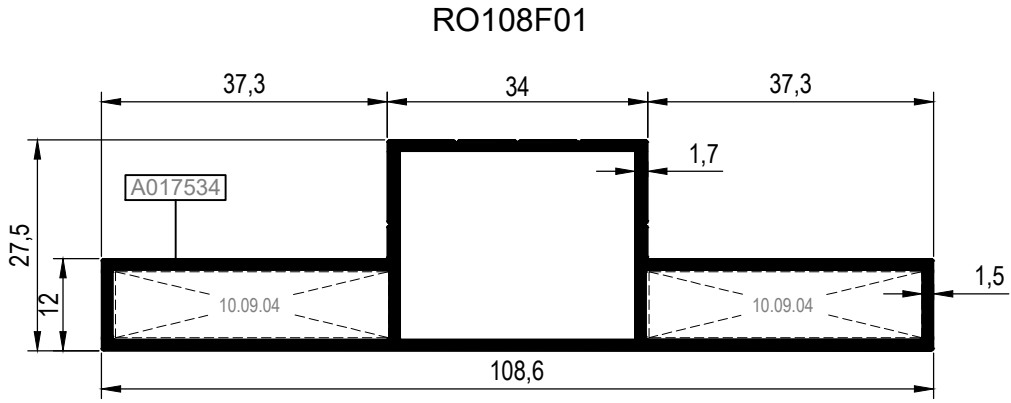

KOD / CODE	AĞIRLIK (kg/m) / WEIGHT	Jxx cm ⁴	Jyy cm ⁴	L m	
**RO108F03	2,424	64,613	86,151	6	



**RO108F03

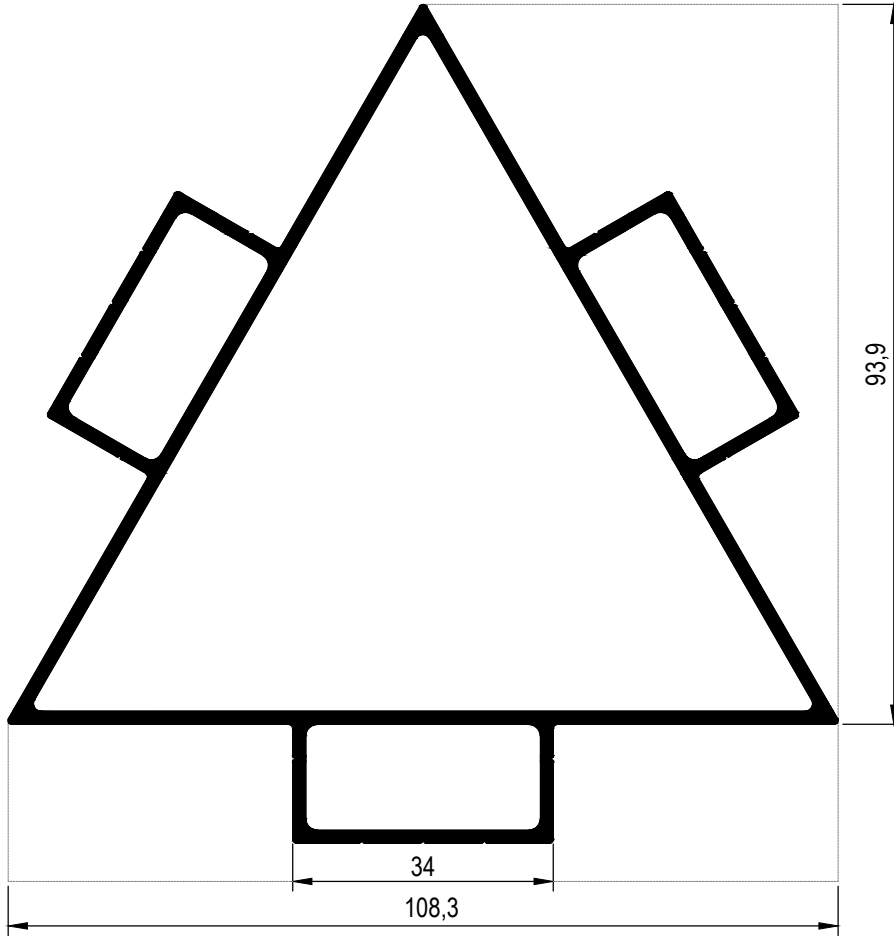

**Kalıp aktif değildir. Sipariş üzerine yapılacaktır.
The die is not active. It will be produced by order.

KOD / CODE	AĞIRLIK (kg/m) / WEIGHT	Jxx cm ⁴	Jyy cm ⁴	L m	
**R0108F05	2,646	----	----	6	

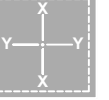

R0108F05

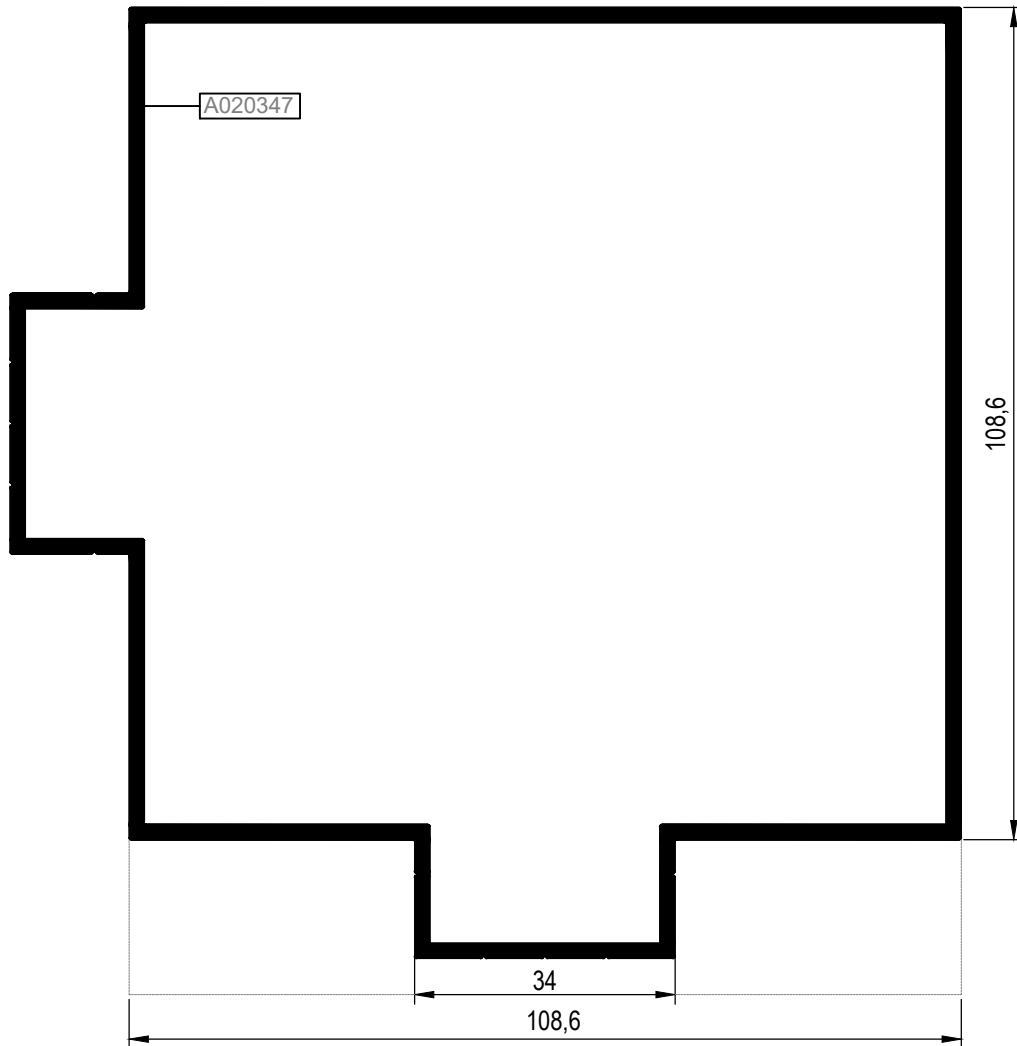

KOD / CODE	AĞIRLIK (kg/m) / WEIGHT	Jxx cm ⁴	Jyy cm ⁴	L m	
**R0108F06	2,65	----	----	6	



**R0108F06

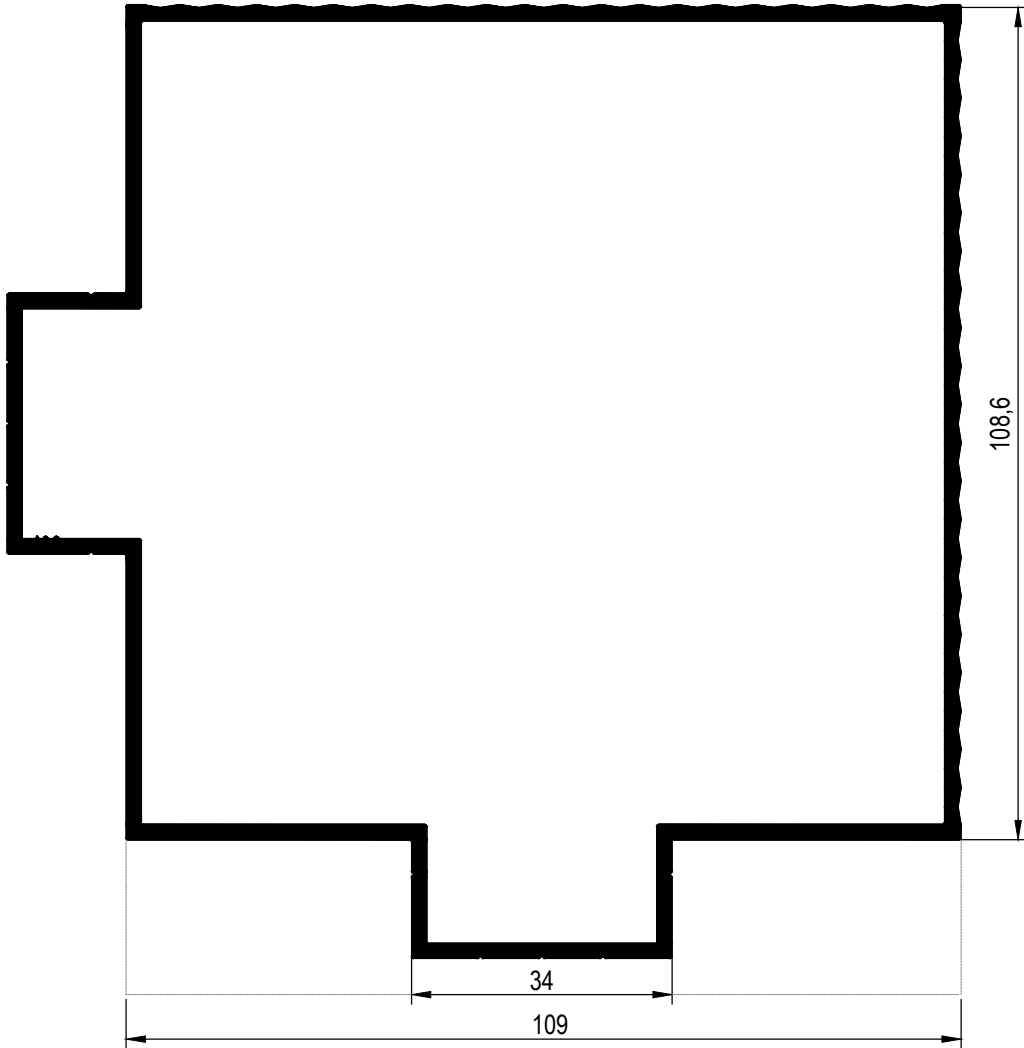

**Kalıp aktif değildir. Sipariş üzerine yapılacaktır.
The die is not active. It will be produced by order.

KOD / CODE	AĞIRLIK (kg/m) / WEIGHT	Jxx cm ⁴	Jyy cm ⁴	L m	
RO108M01	0,429	2,478	1,237	6	
**RO108M02	0,470	----	----	6	
**RO108A03	0,138	----	----	6	

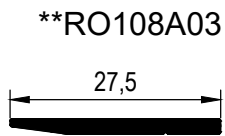
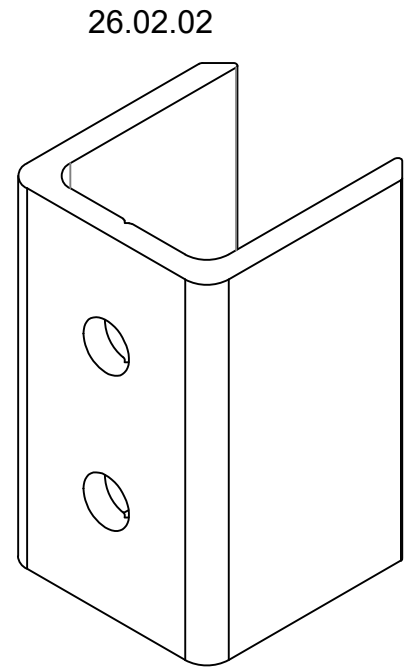
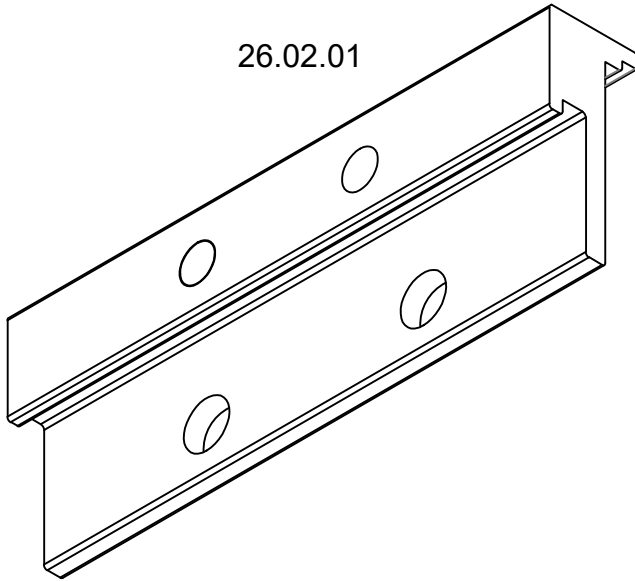
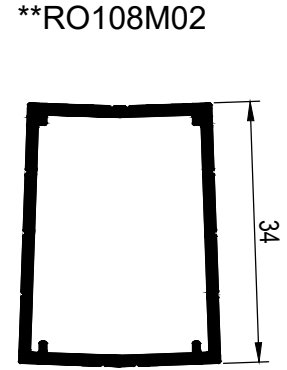
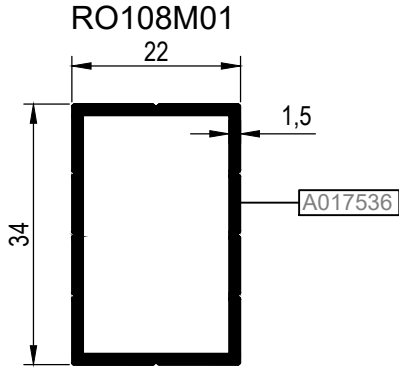

**Kalıp aktif değildir. Sipariş üzerine yapılacaktır.
The die is not active. It will be produced by order.

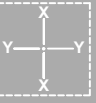
KOD / CODE	AĞIRLIK (kg/m) / WEIGHT	Jxx cm ⁴	Jyy cm ⁴	L m	
RO108V01	0,457	0,343	3,401	6	
RO108V02	0,422	0,444	2,215	6	
**RO108V03	0,543	----	----	6	
RO108V04	0,515	----	----	6	
**RO108V07	0,486	0,381	4,014	6	
**RO108V09	0,400	----	----	6	
**RO108V10	0,478	----	----	6	
**RO108V11	0,468	----	----	6	

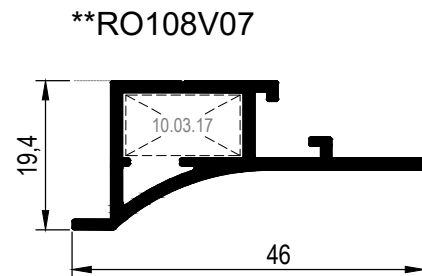
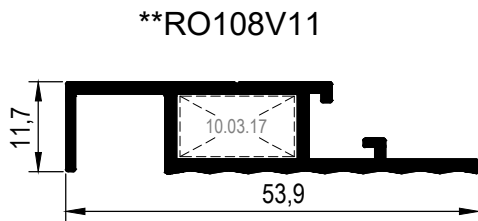
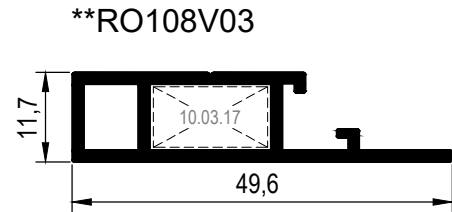
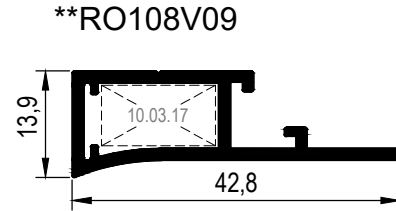
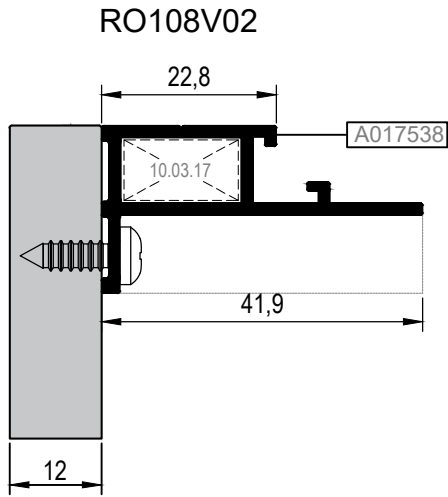
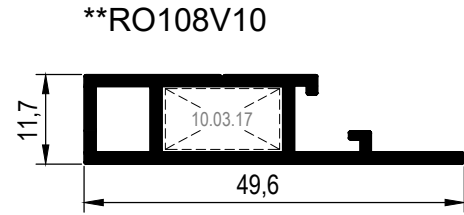
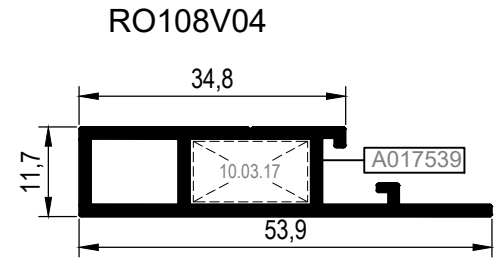
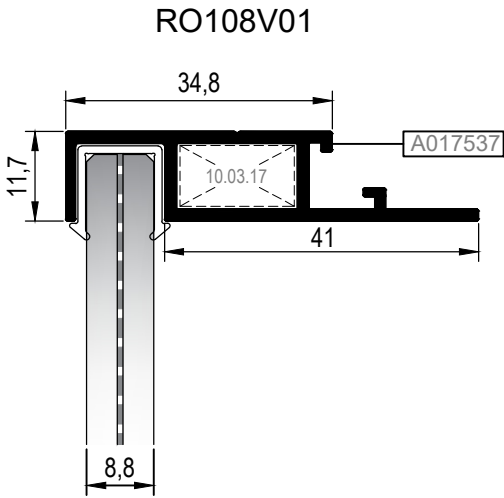

**Kalıp aktif değildir. Sipariş üzerine yapılacaktır.
The die is not active. It will be produced by order.

KOD / CODE	AĞIRLIK (kg/m) / WEIGHT	Jxx cm ⁴	Jyy cm ⁴	L m	
RO108V05	1,370	12,737	91,364	6	
RO108V06	1,622	18,936	93,059	6	

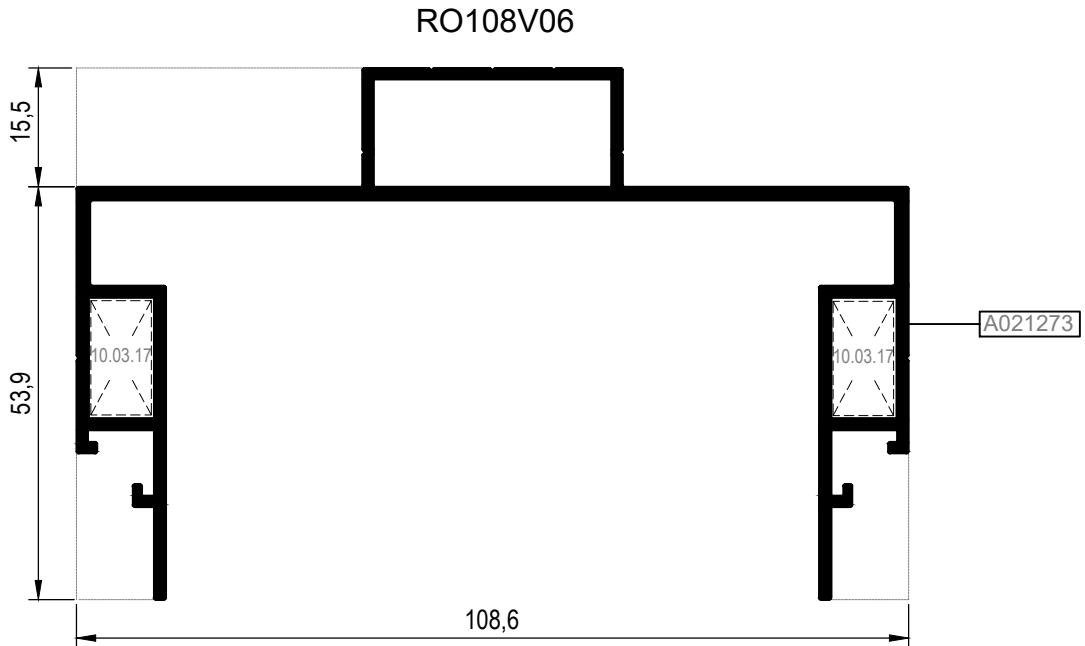
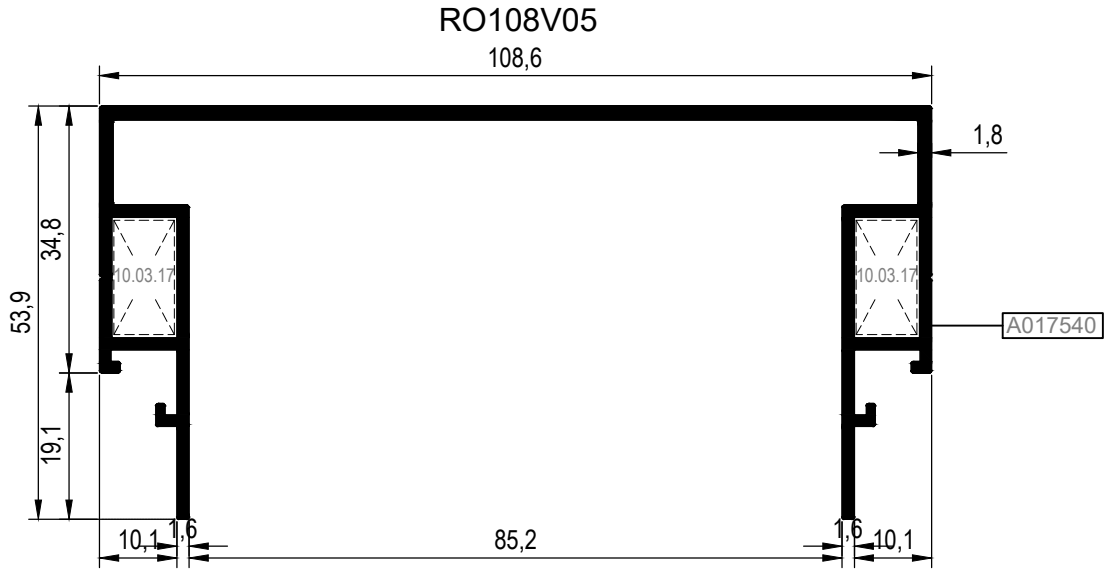

KOD / CODE	AĞIRLIK (kg/m) / WEIGHT	Jxx cm ⁴	Jyy cm ⁴	L m	
RO108V08	0,606	1,142	4,297	6	
RO77V01	0,269	----	----	6	

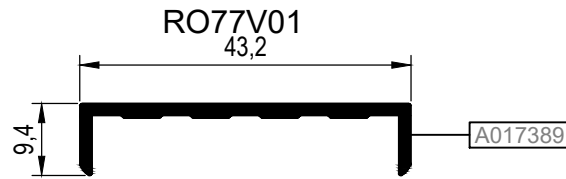
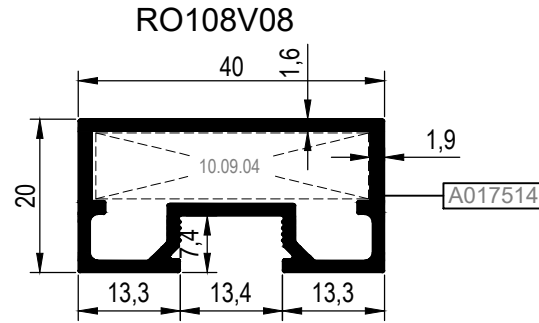

AKSESUAR KODU (ACCESSORIES CODE)	10.09.04	10.03.17	
PROFİL KODU (PROFILE CODE)	Pimli bağlantılı köşe takozu (Corner cleat with pin connection)	Pimli bağlantılı köşe takozu (Corner cleat with pin connection)	
ÇİZİM (DRAWING)			

KÖŞE TAKOZLARI (CORNER CLEATS)

Nr		AKS. KODU ACS. CODE
RO108F01	A017534	10.09.04
		10.09.04
RO108F02	A017535	10.03.17
RO108F04	A017543	10.03.17
		10.03.17
RO108V01	A017537	10.03.17
RO108V02	A017538	10.03.17
RO108V03	----	10.03.17
RO108V04	A017539	10.03.17
RO108V05	A017540	10.03.17
		10.03.17
RO108V06	A021273	10.03.17
		10.03.17
RO108V07	----	10.03.17
RO108V09	----	10.03.17
RO108V10	----	10.03.17
RO108V11	----	10.03.17
RO108V08	A017514	10.09.04

MİMARİ KATALOG
ARCHITECTURAL CATALOGUE

Alüminyum Konvansiyonel Sistemleri
Aluminium Conventional Systems

RO108

DETAYLAR

DETAILS

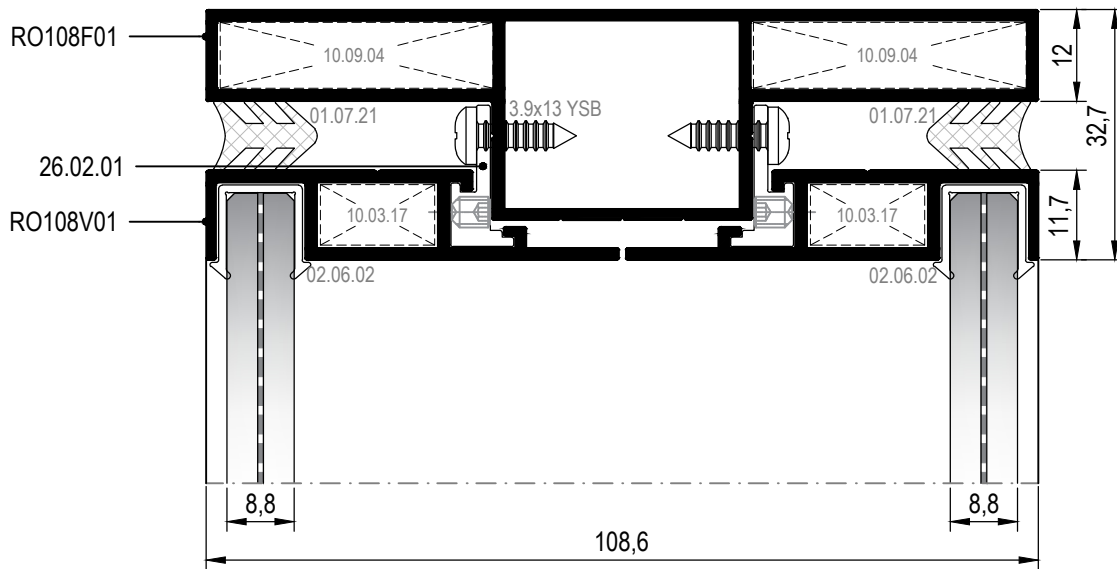
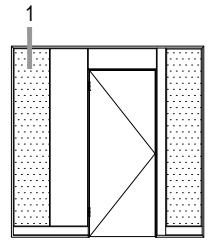

① DETAYI
DETAIL

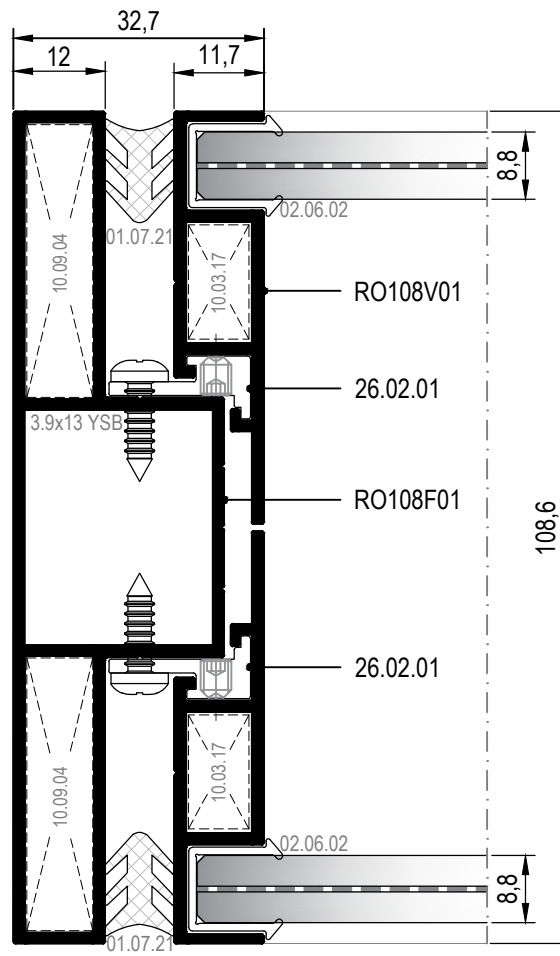
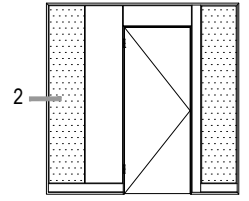

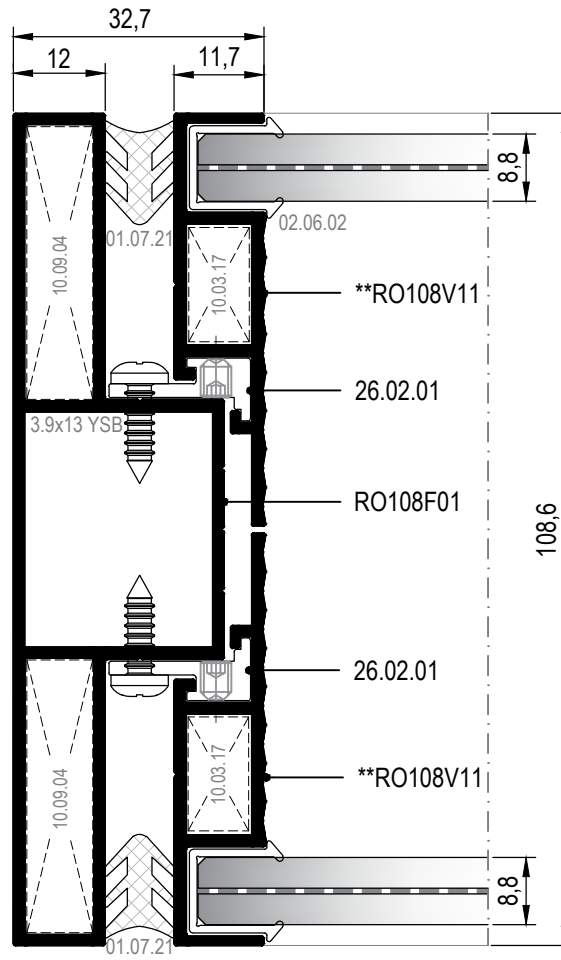
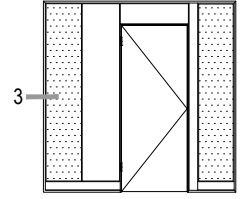

**Kalıp aktif değildir. Sipariş üzerine yapılacaktır.
The die is not active. It will be produced by order.

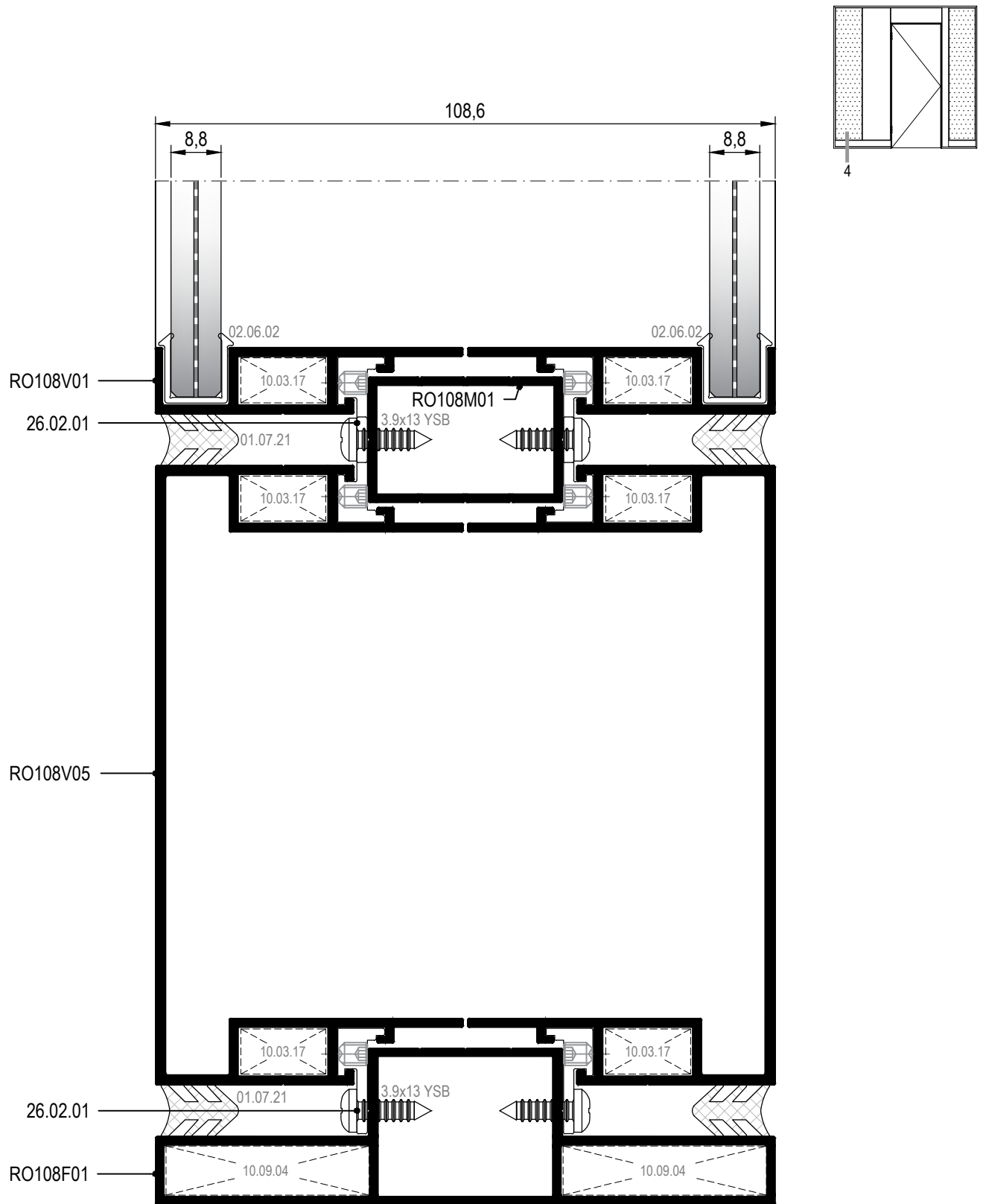

④ DETAYI
DETAIL

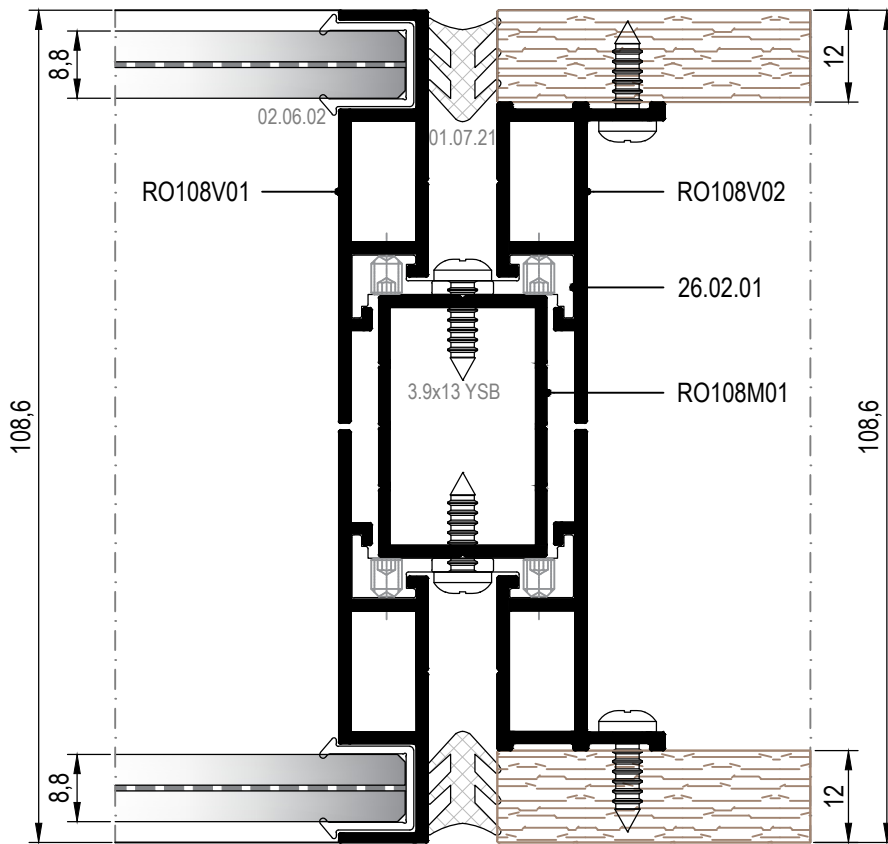
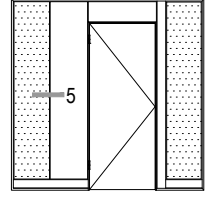

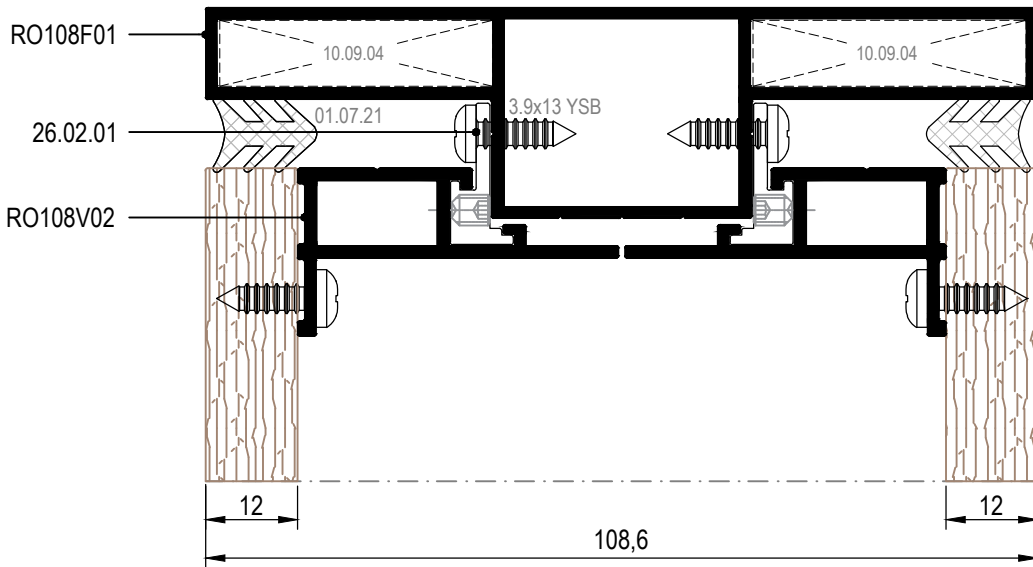
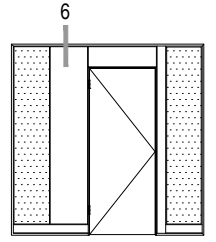

⑥ DETAYI
DETAIL

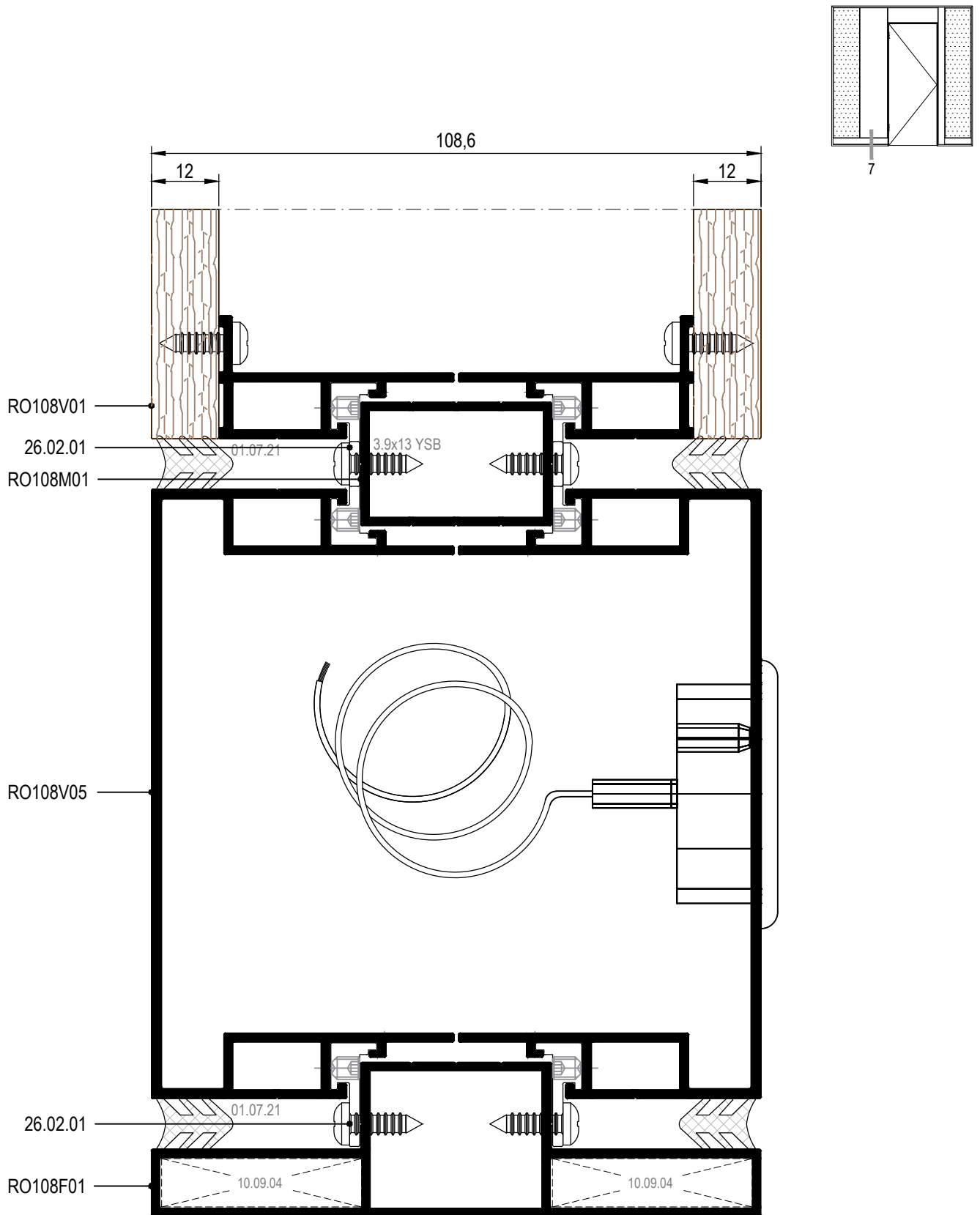

⑦ DETAYI
DETAIL

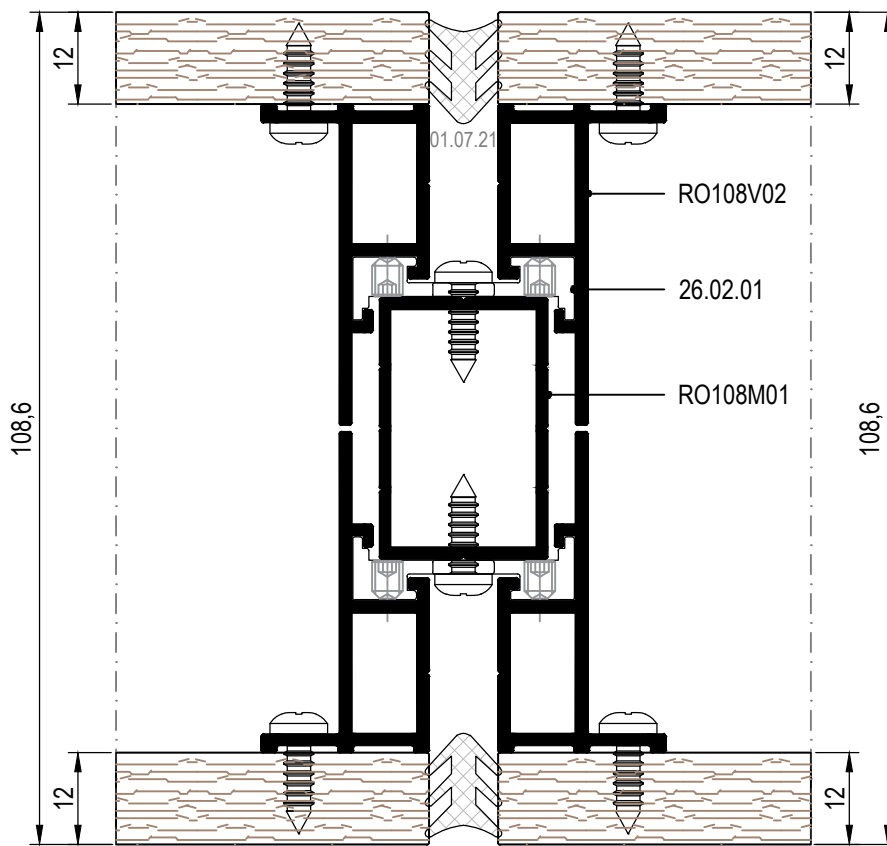
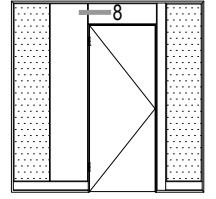

ALÜMİNYUM KASA AHŞAP KAPI DETAYI
WOOD DOOR WITH ALUMINIUM FRAME DETAIL

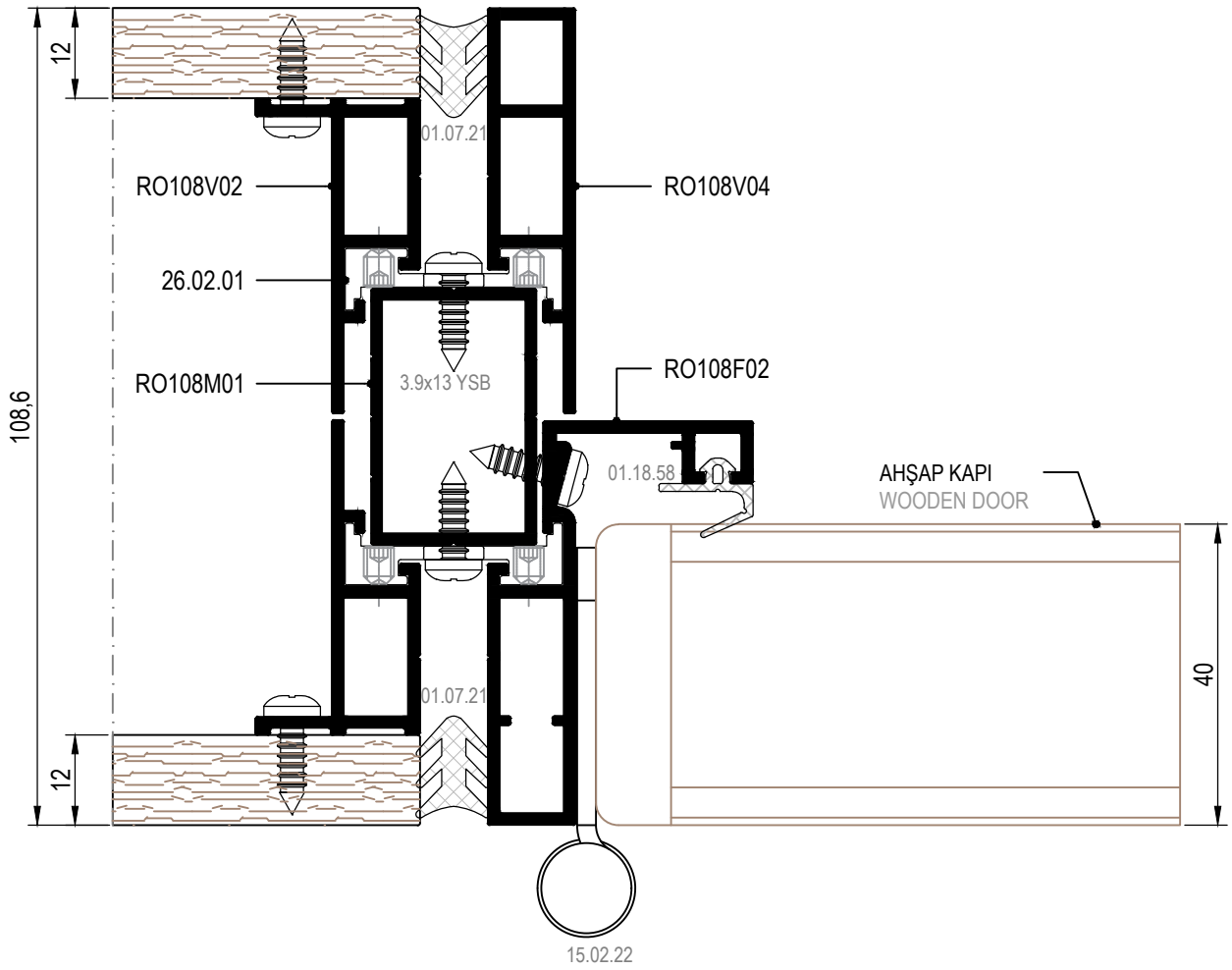
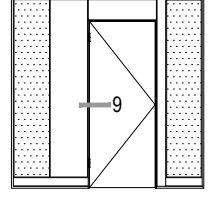

9 DETAYI
DETAIL

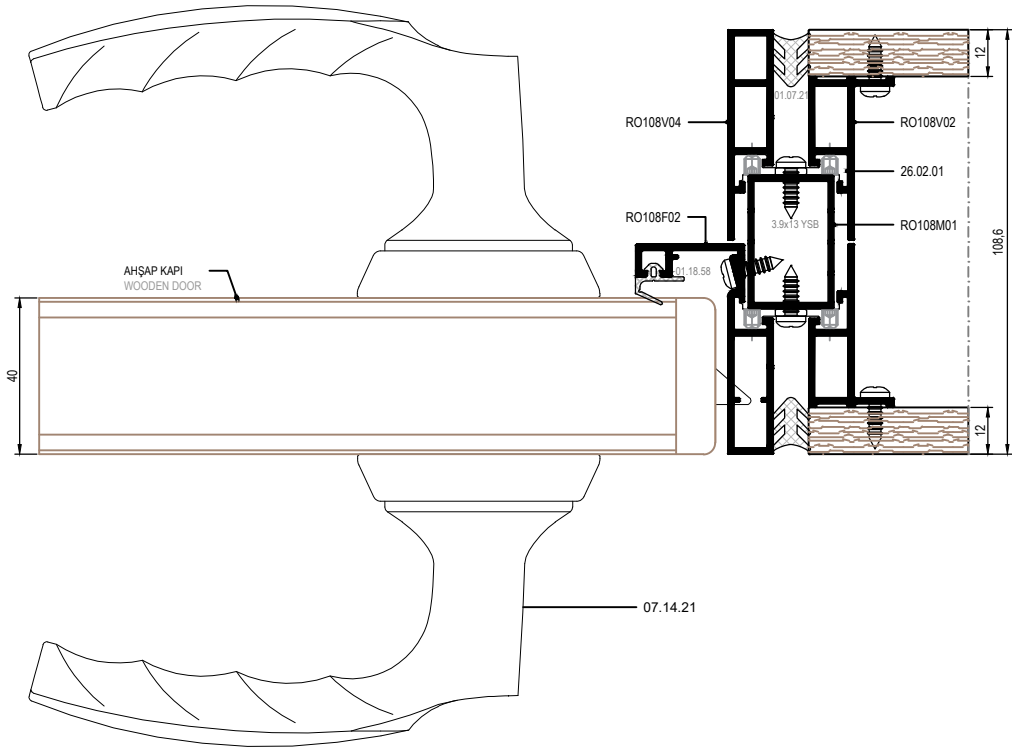
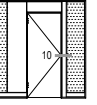

ALÜMİNYUM KASA AHŞAP KAPI DETAYI
WOOD DOOR WITH ALUMINIUM FRAME DETAIL

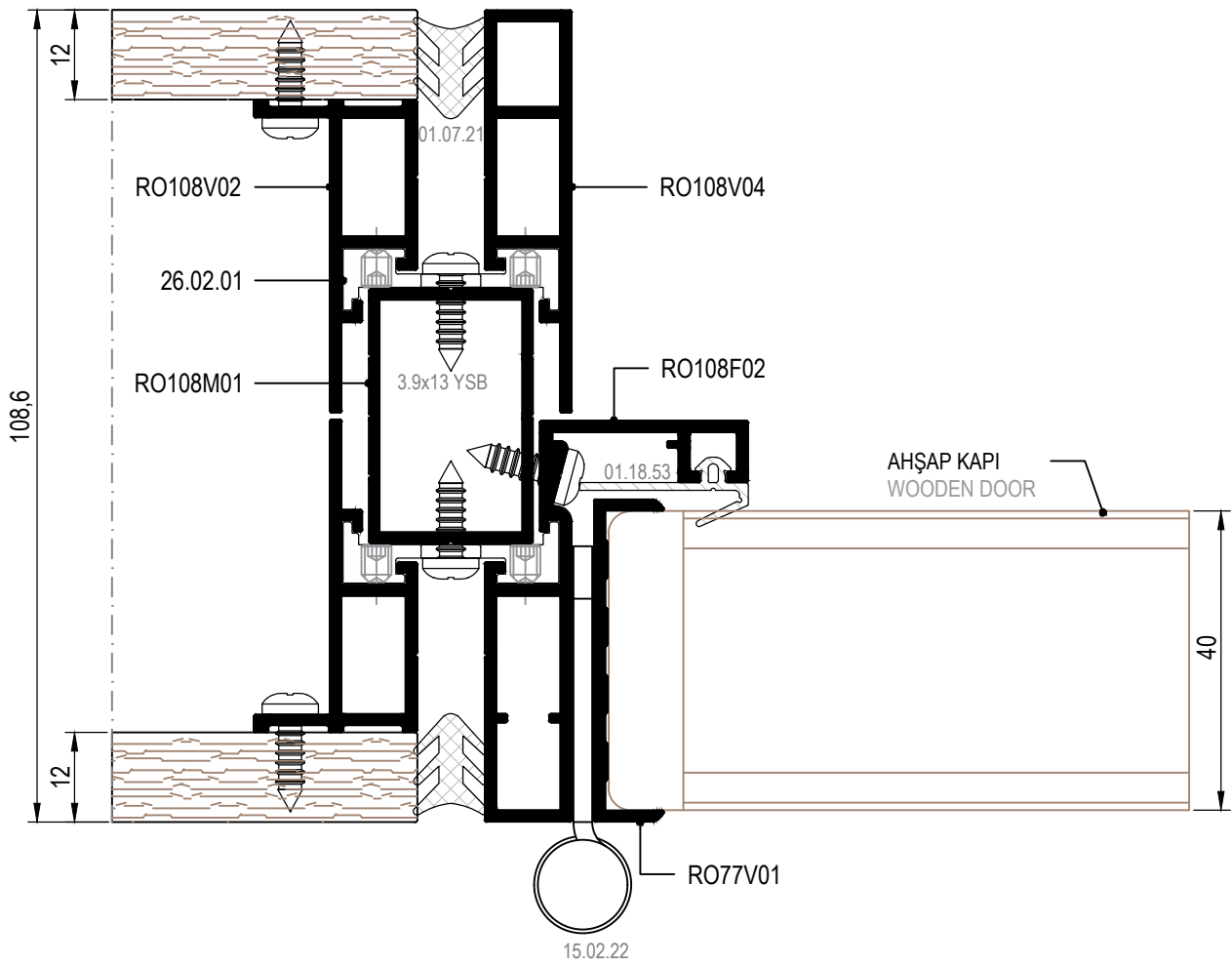
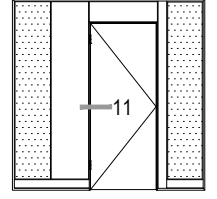

11 DETAYI
DETAIL

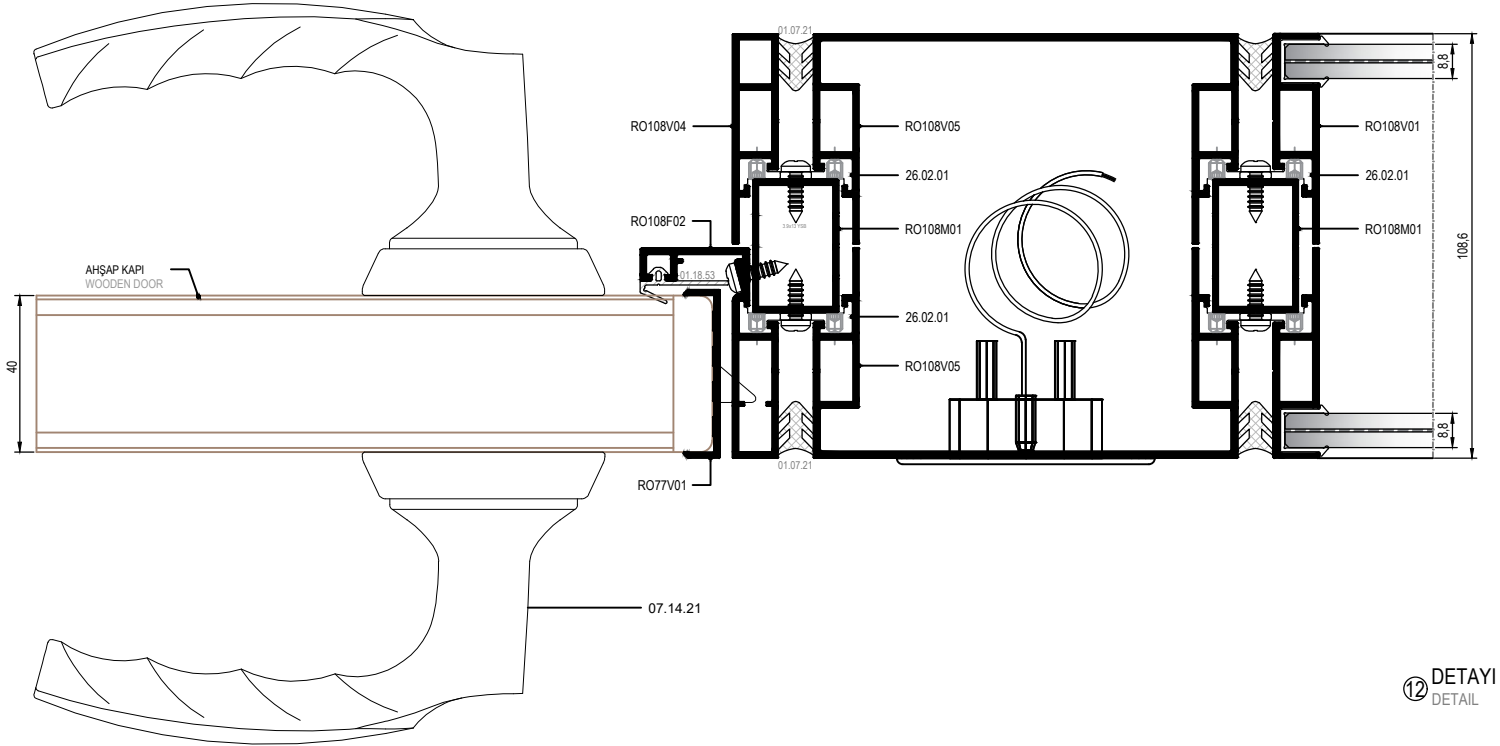
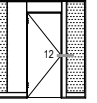

ALÜMİNYUM KASA AHŞAP KAPI DETAYI
WOOD DOOR WITH ALUMINIUM FRAME DETAIL

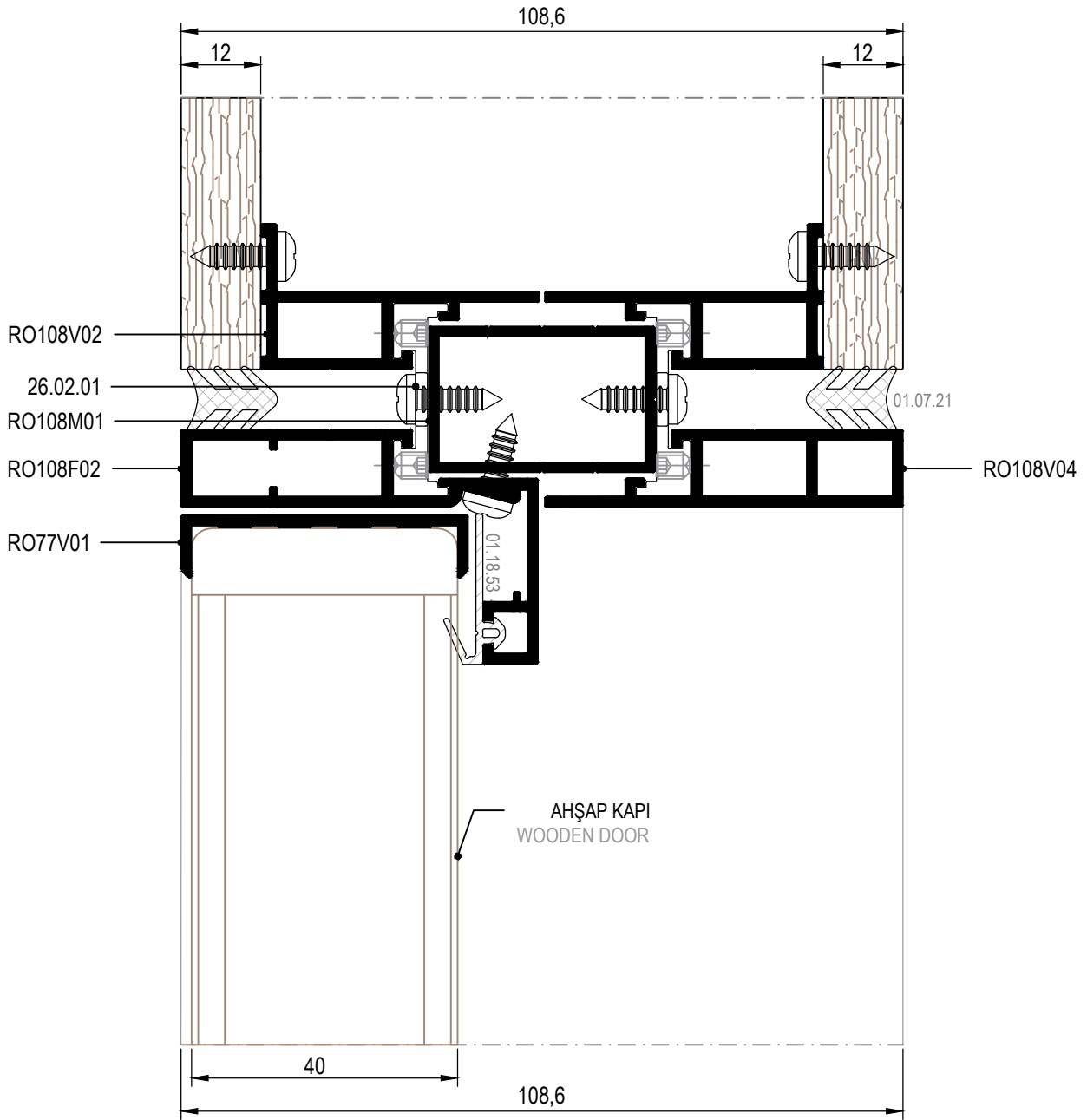
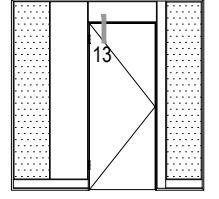

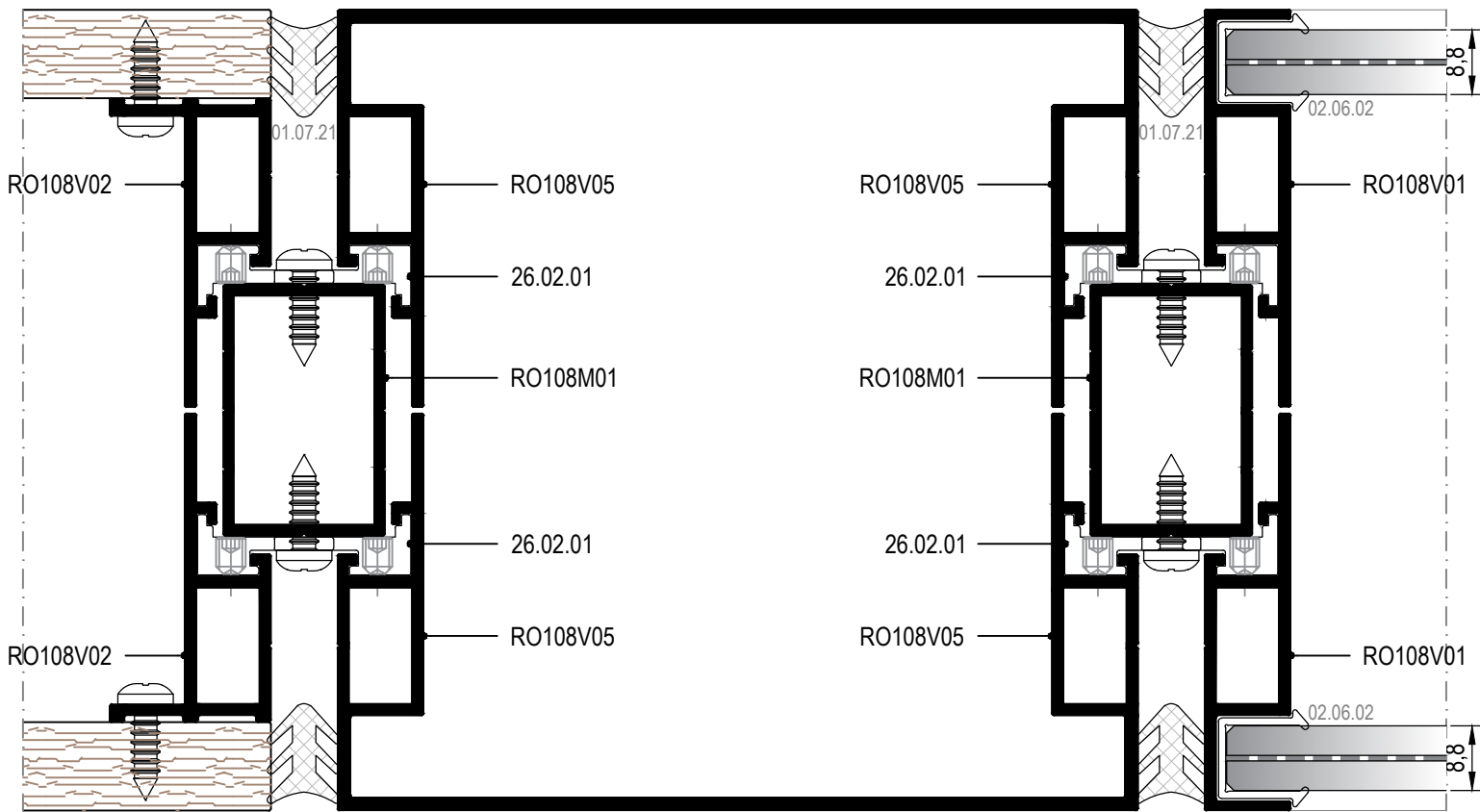
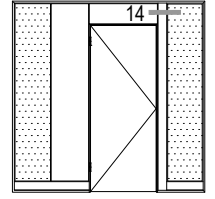

14 DETAYI
DETAIL

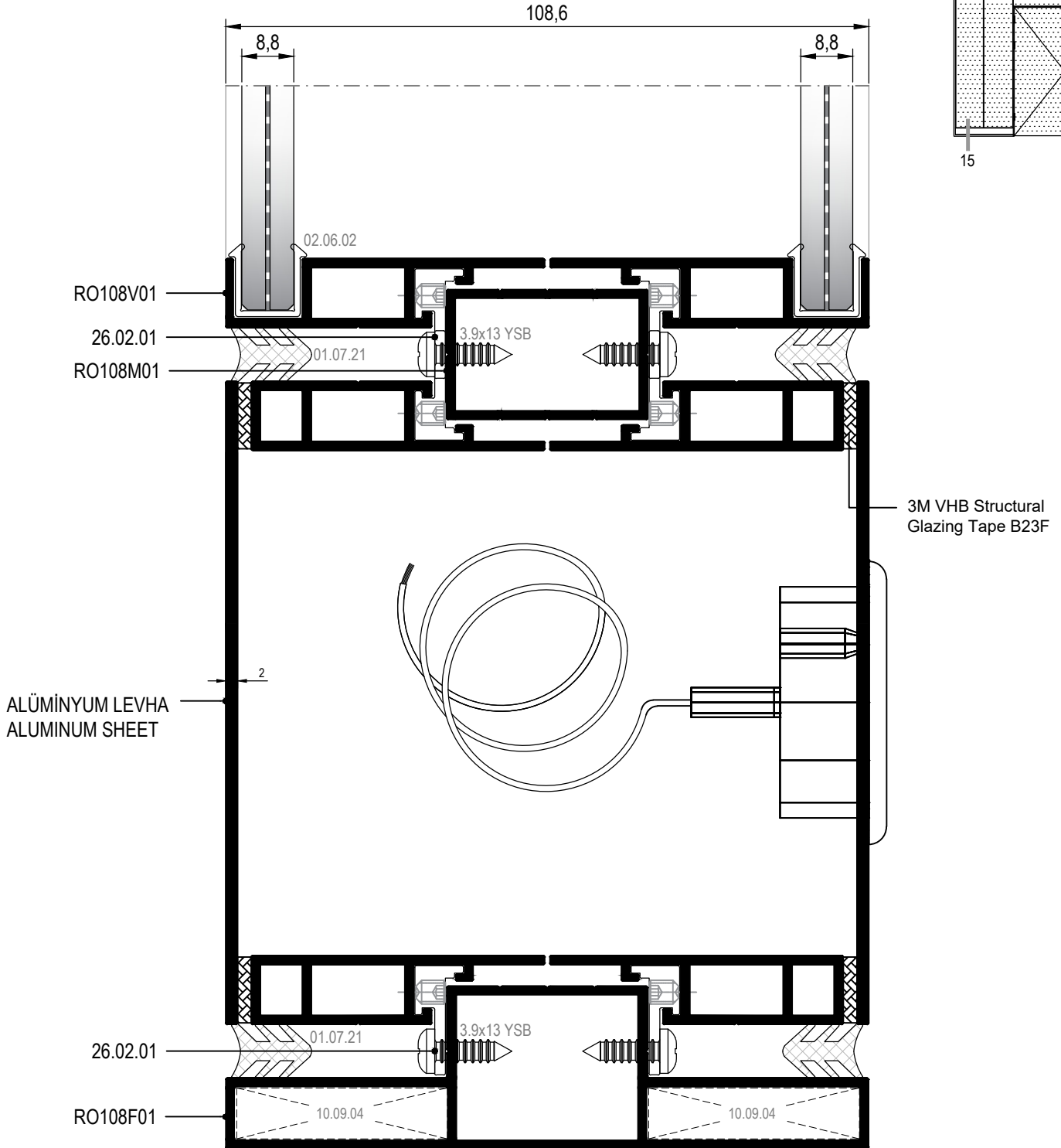

ALÜMİNYUM KASA ALÜMİNYUM ÇERÇEVELİ CAM KAPI DETAYI
GLASS DOOR WITH ALUMINIUM FRAME DETAIL

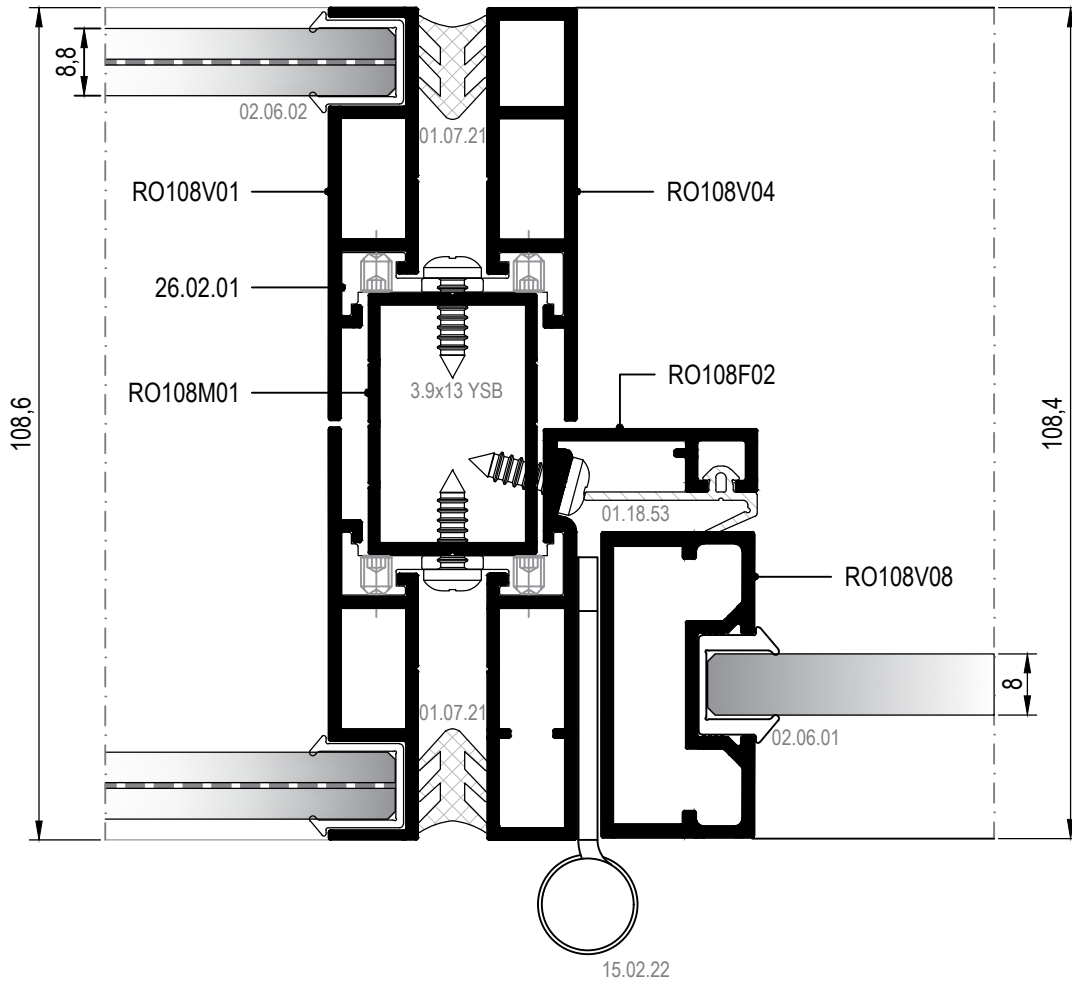
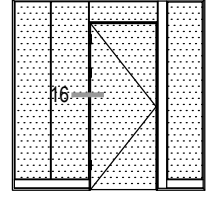

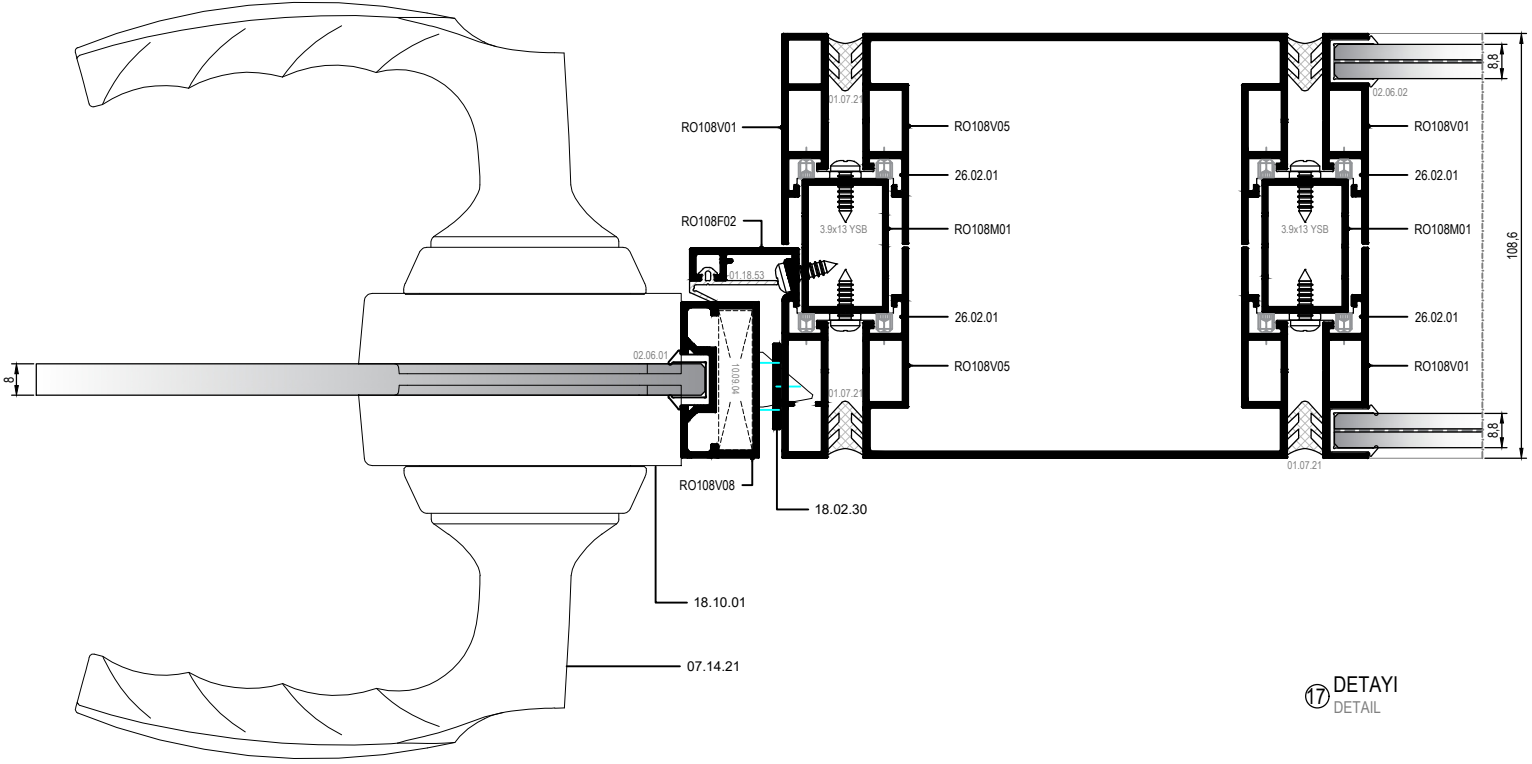
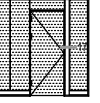

ALÜMİNYUM KASA ALÜMİNYUM ÇERÇEVELİ CAM KAPI DETAYI
GLASS DOOR WITH ALUMINIUM FRAME DETAIL

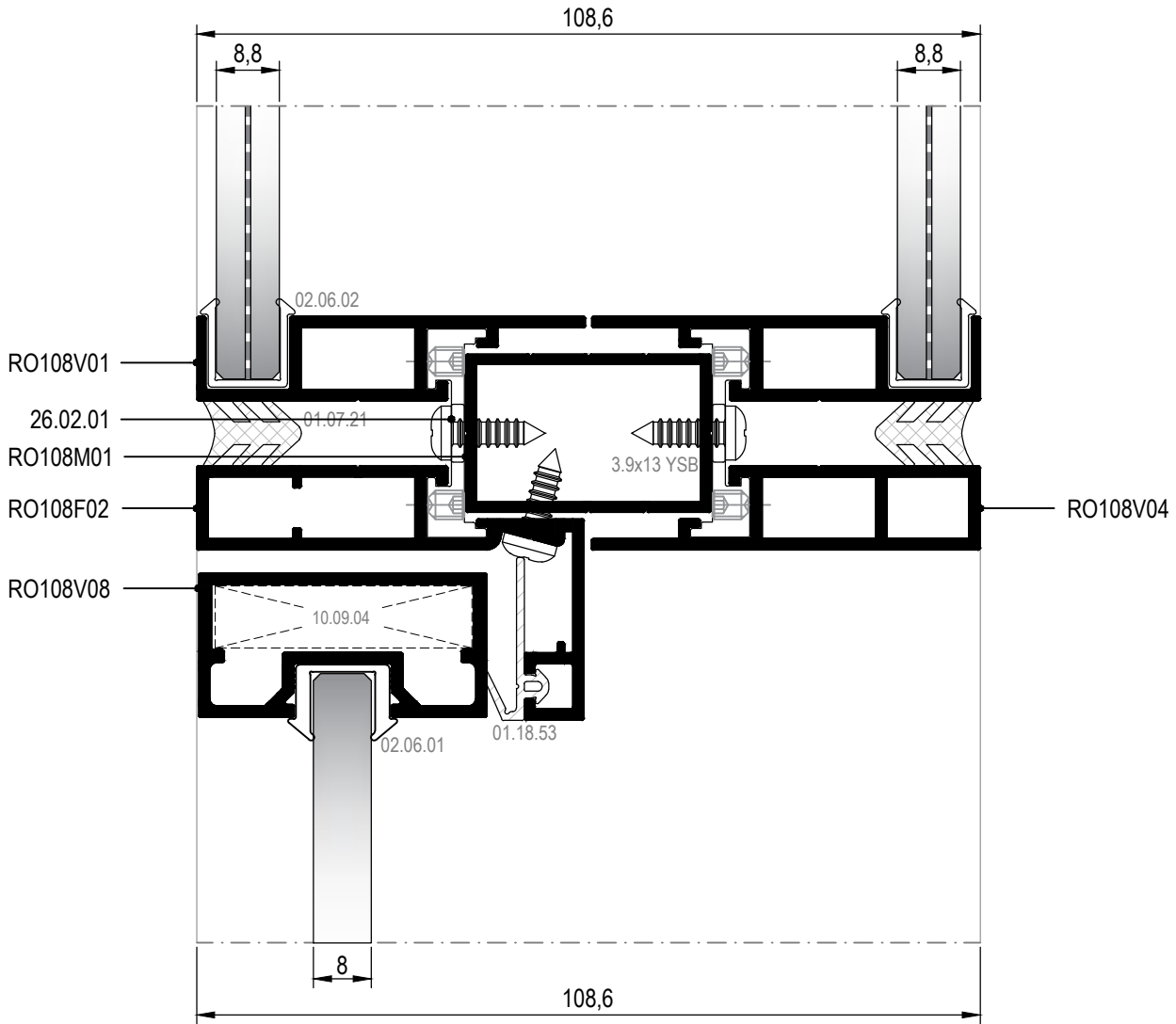
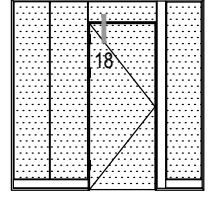

ALÜMİNYUM KASA CAM KAPI DETAYI
GLASS DOOR WITH ALUMINIUM FRAME DETAIL

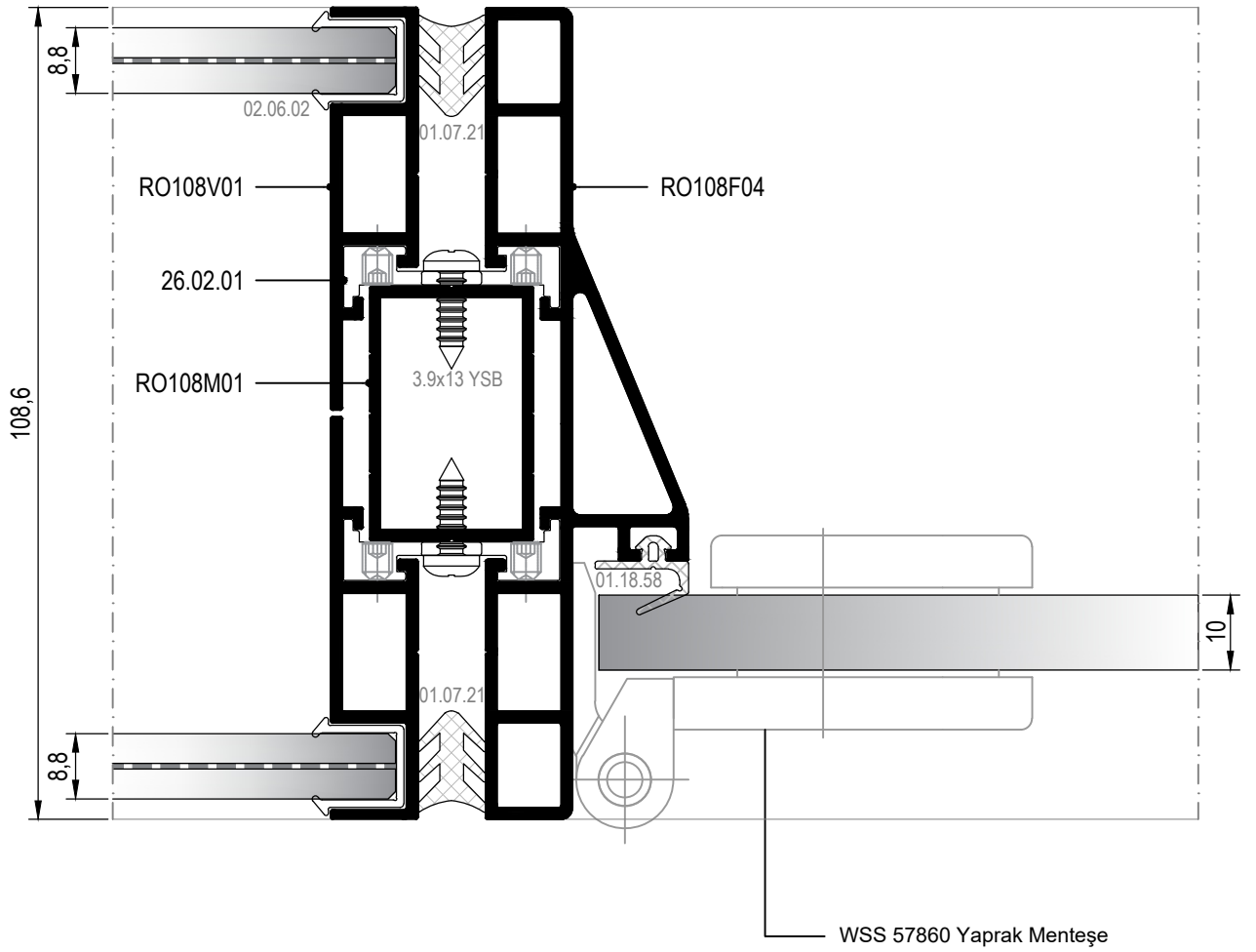
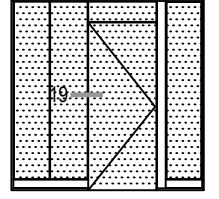

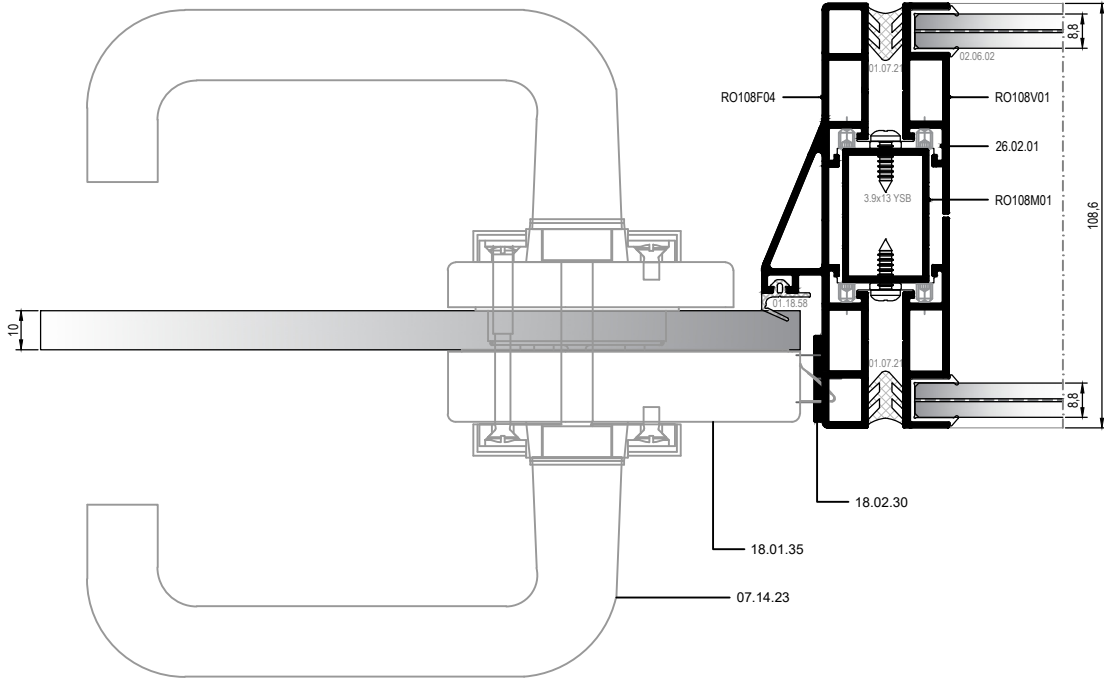

ALÜMİNYUM KASA CAM KAPI DETAYI
GLASS DOOR WITH ALUMINIUM FRAME DETAIL

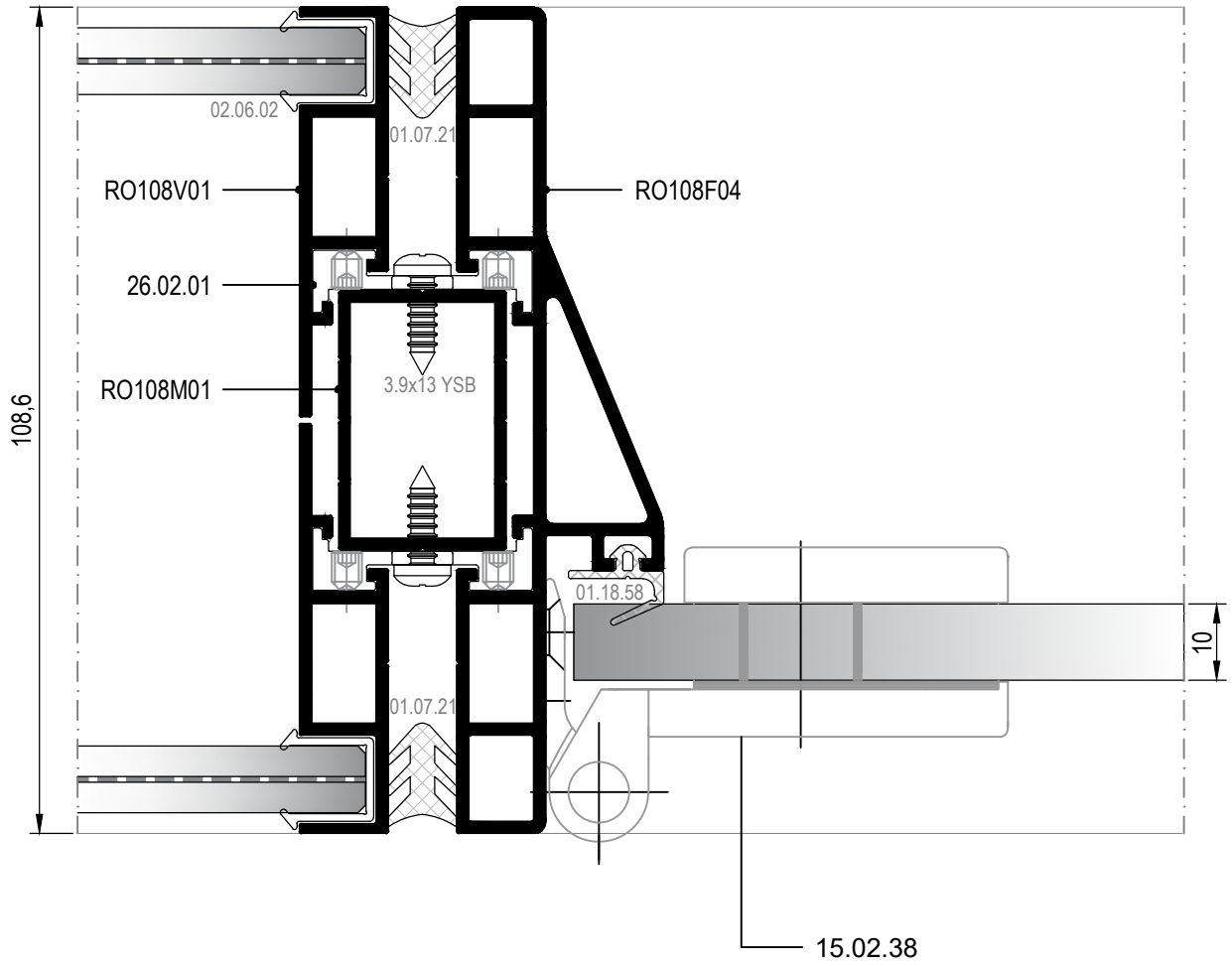
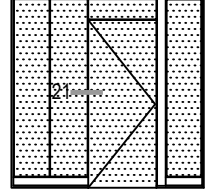

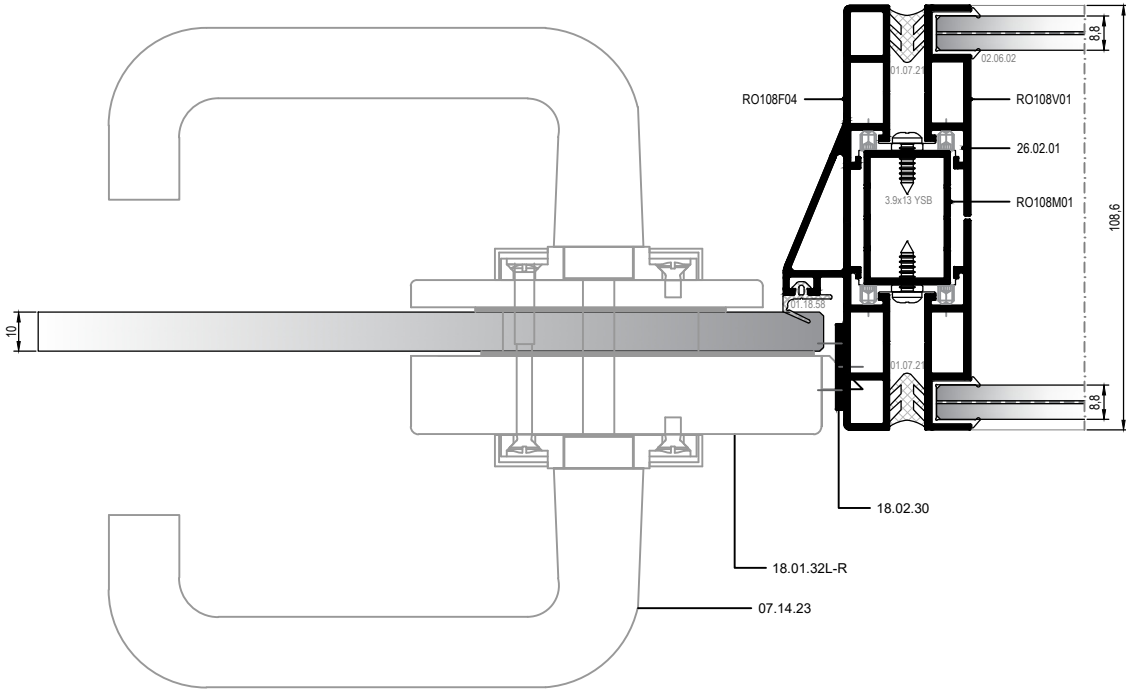

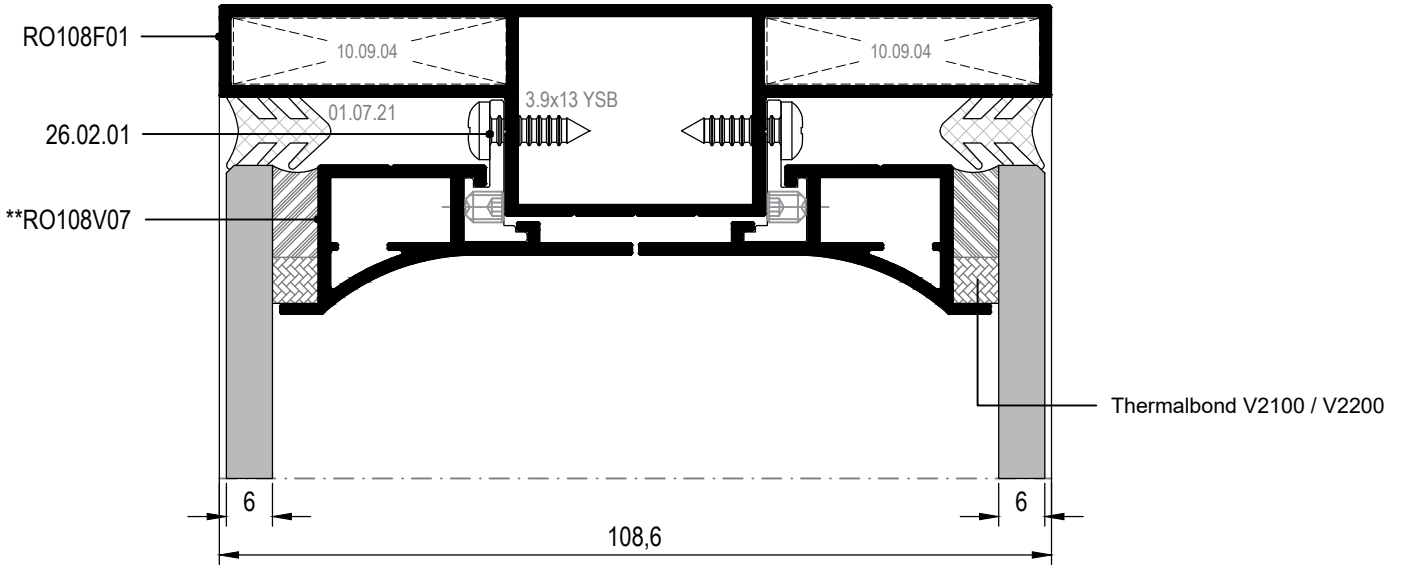
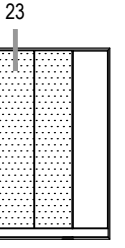

**Kalıp aktif değildir. Sipariş üzerine yapılacaktır.
The die is not active. It will be produced by order.

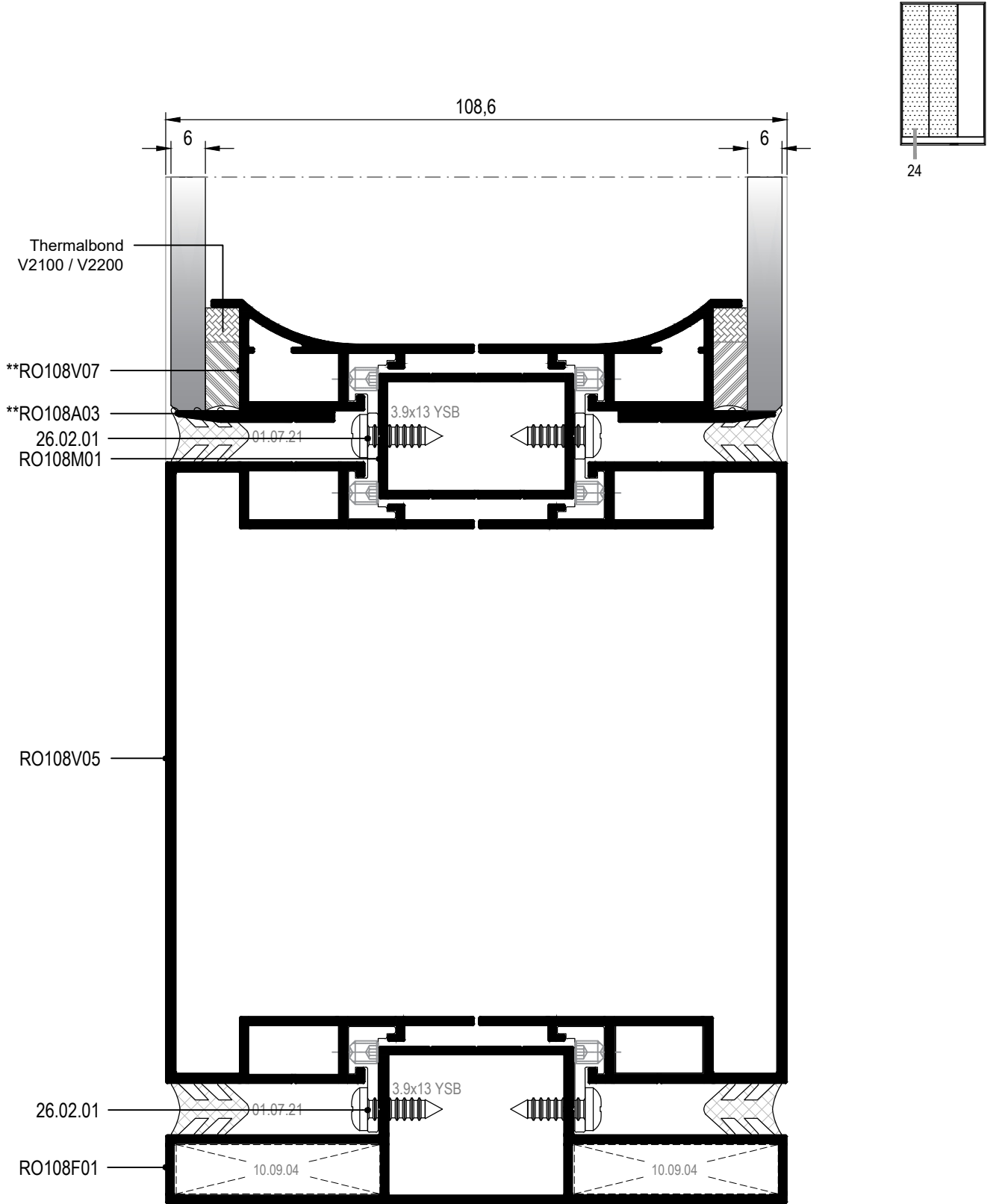

24 DETAYI
DETAIL

**Kalıp aktif değildir. Sipariş üzerine yapılacaktır.
The die is not active. It will be produced by order.

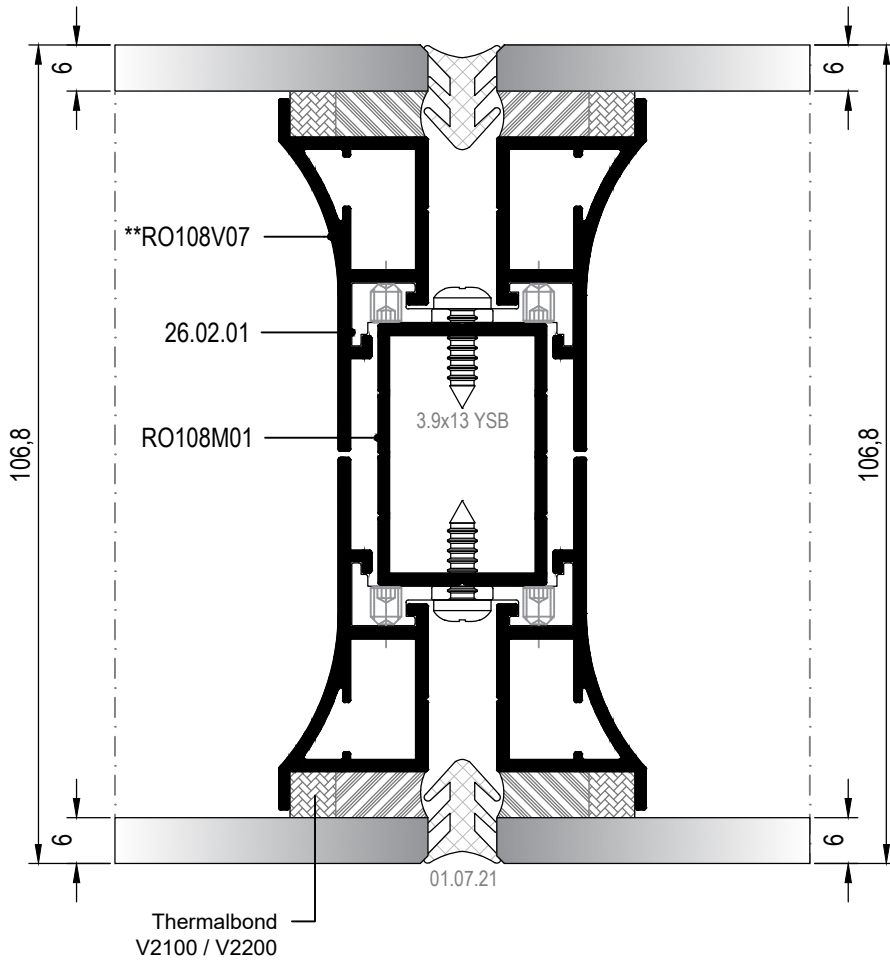
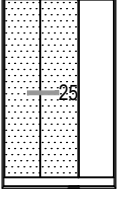

**Kalıp aktif değildir. Sipariş üzerine yapılacaktır.
The die is not active. It will be produced by order.

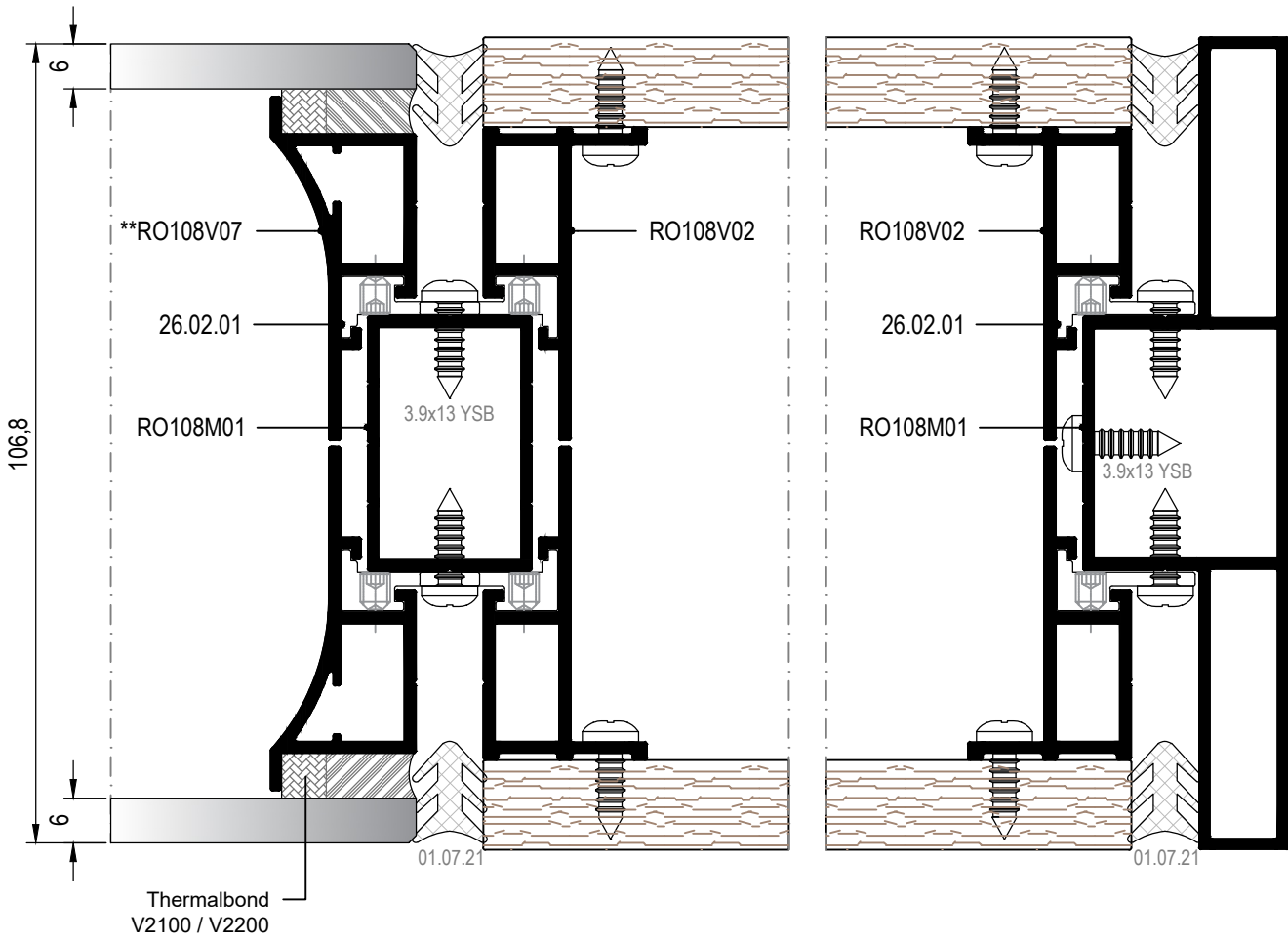
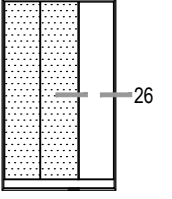

**Kalıp aktif değildir. Sipariş üzerine yapılacaktır.
The die is not active. It will be produced by order.

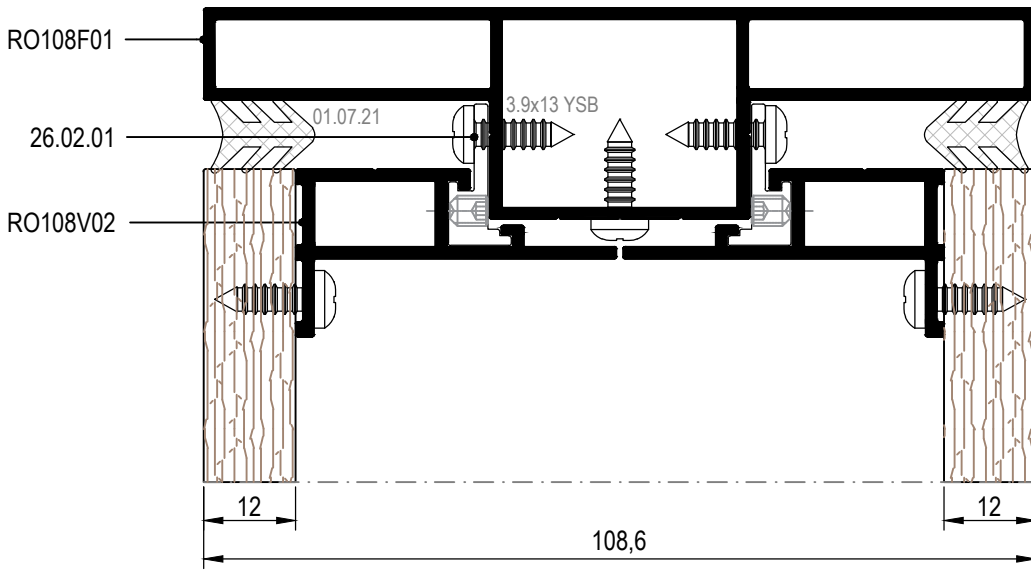
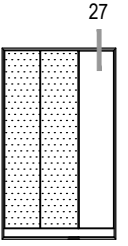

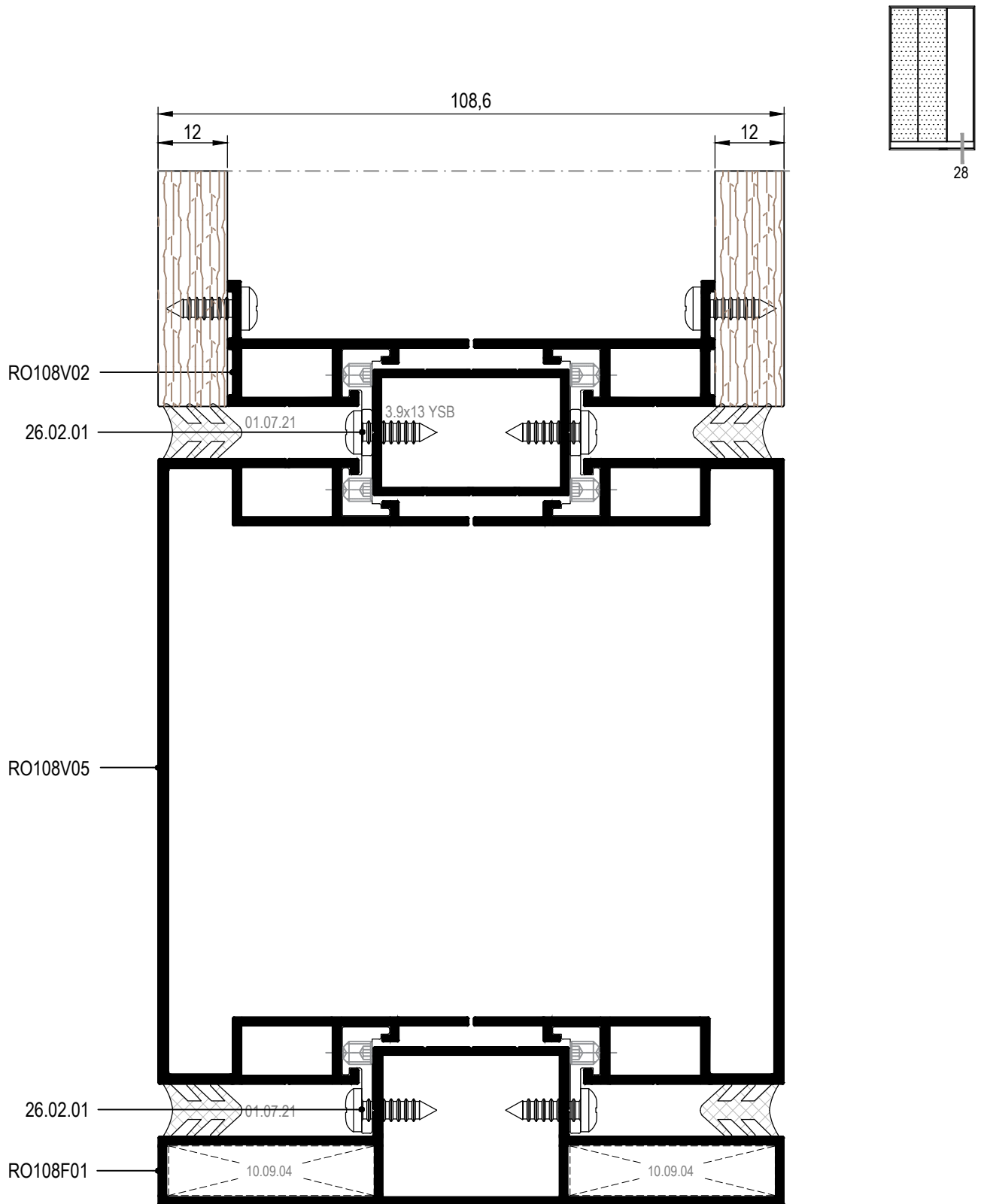

28 DETAYI
DETAIL

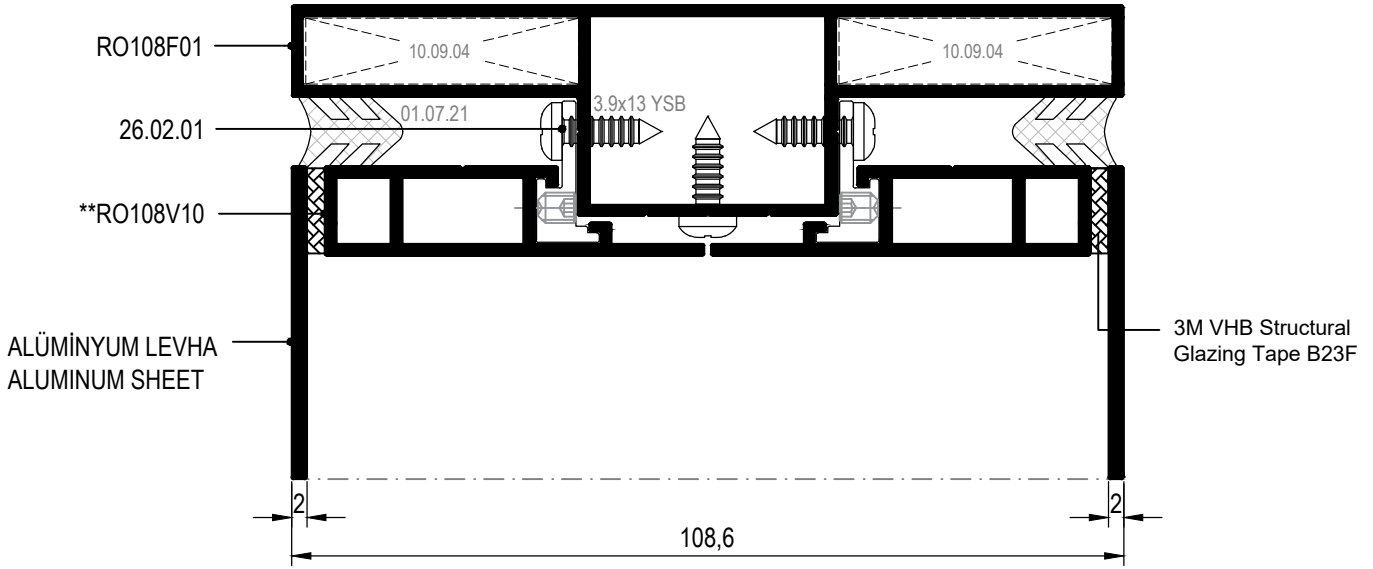
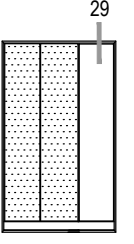

**Kalıp aktif değildir. Sipariş üzerine yapılacaktır.
The die is not active. It will be produced by order.

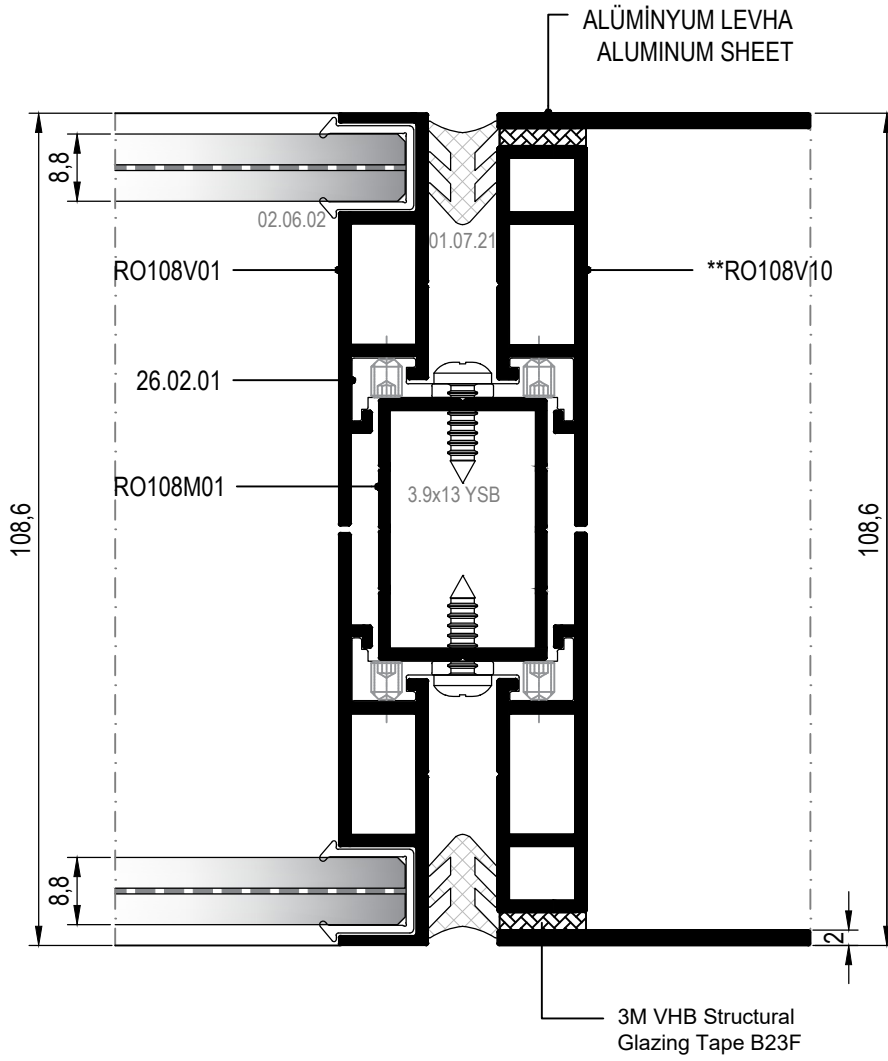
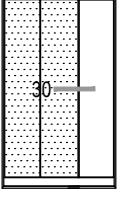

**Kalıp aktif değildir. Sipariş üzerine yapılacaktır.
The die is not active. It will be produced by order.

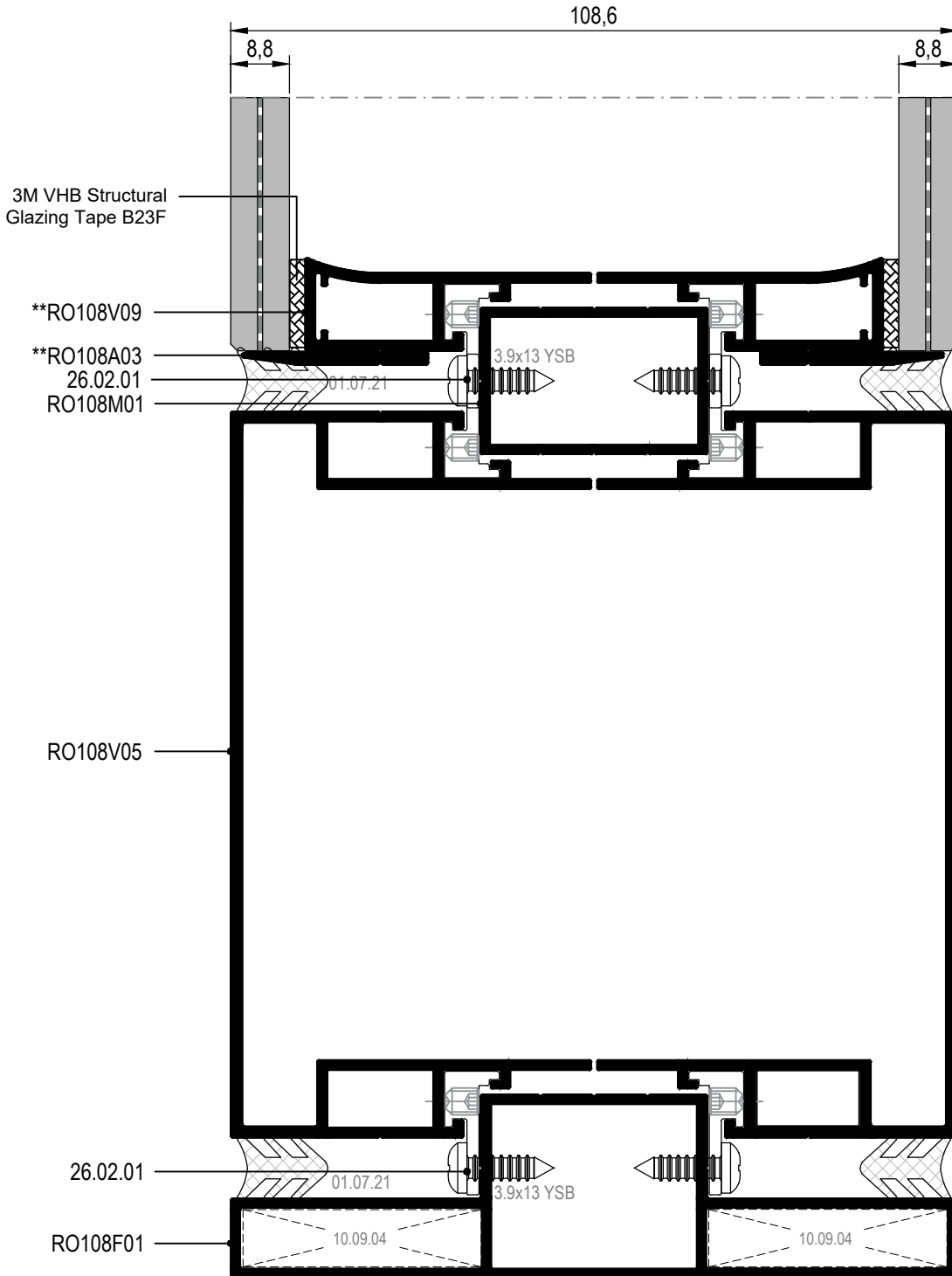

**Kalıp aktif değildir. Sipariş üzerine yapılacaktır.
The die is not active. It will be produced by order.

31 DETAYI
DETAIL

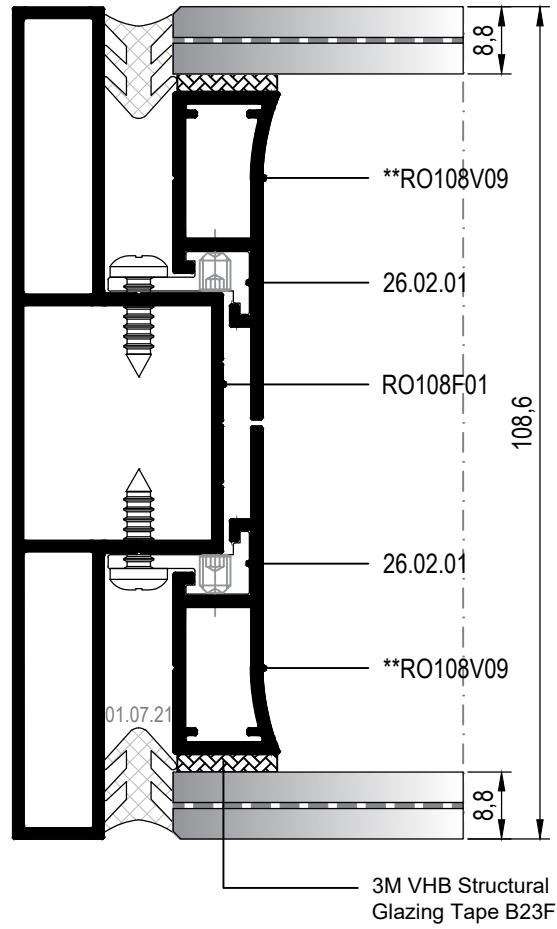
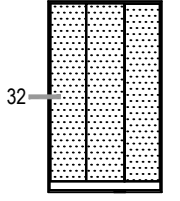

**Kalıp aktif değildir. Sipariş üzerine yapılacaktır.
The die is not active. It will be produced by order.

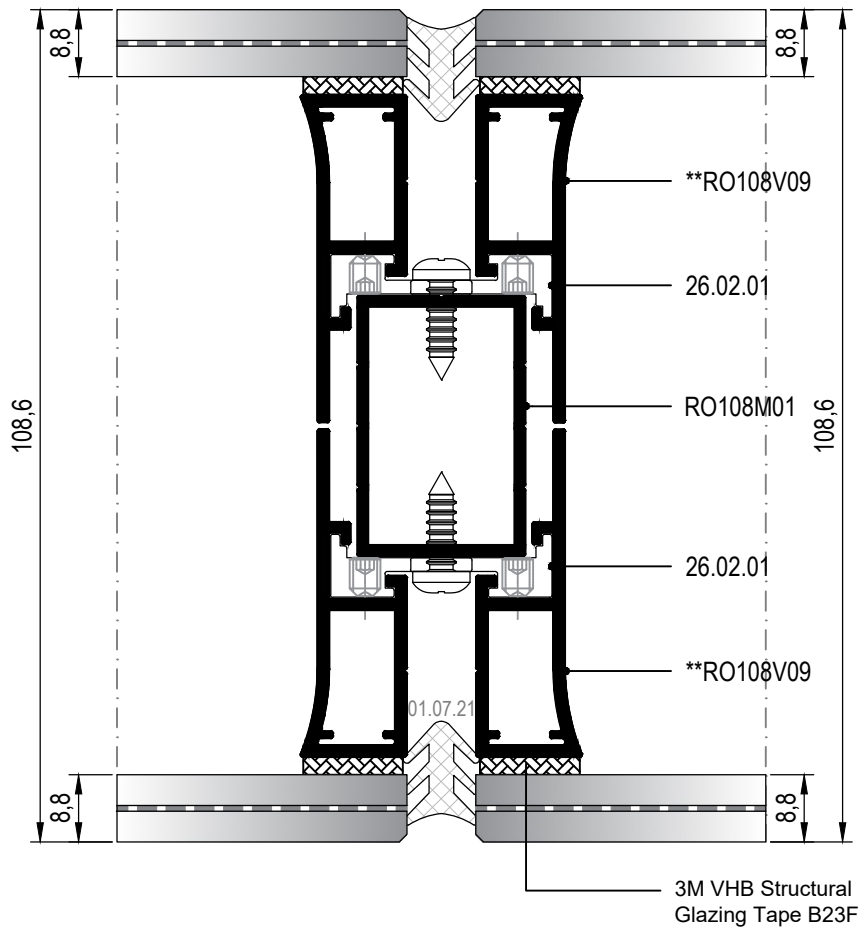
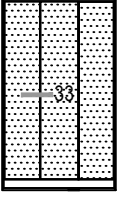

**Kalıp aktif değildir. Sipariş üzerine yapılacaktır.
The die is not active. It will be produced by order.

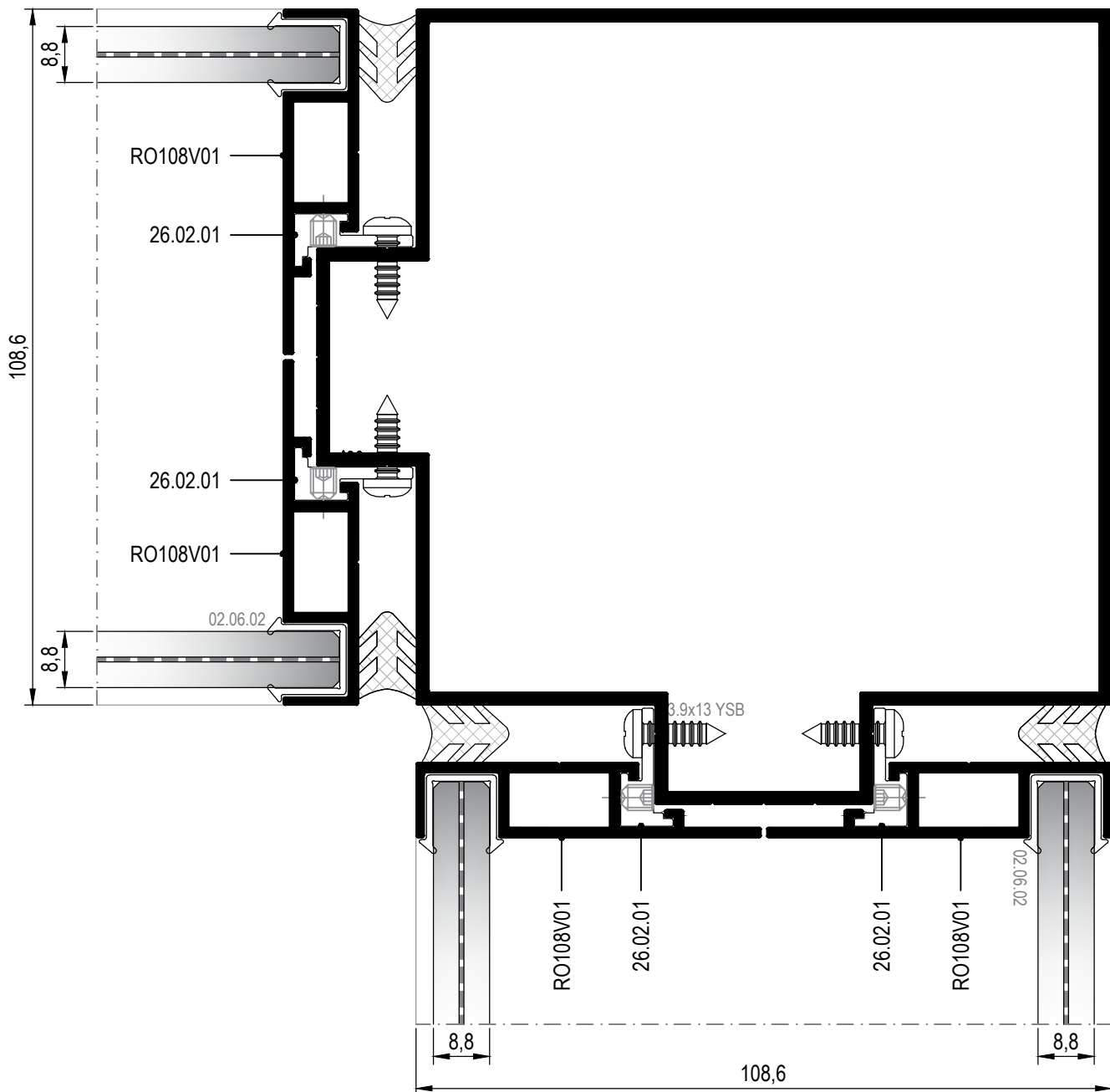

34 DETAYI
DETAIL

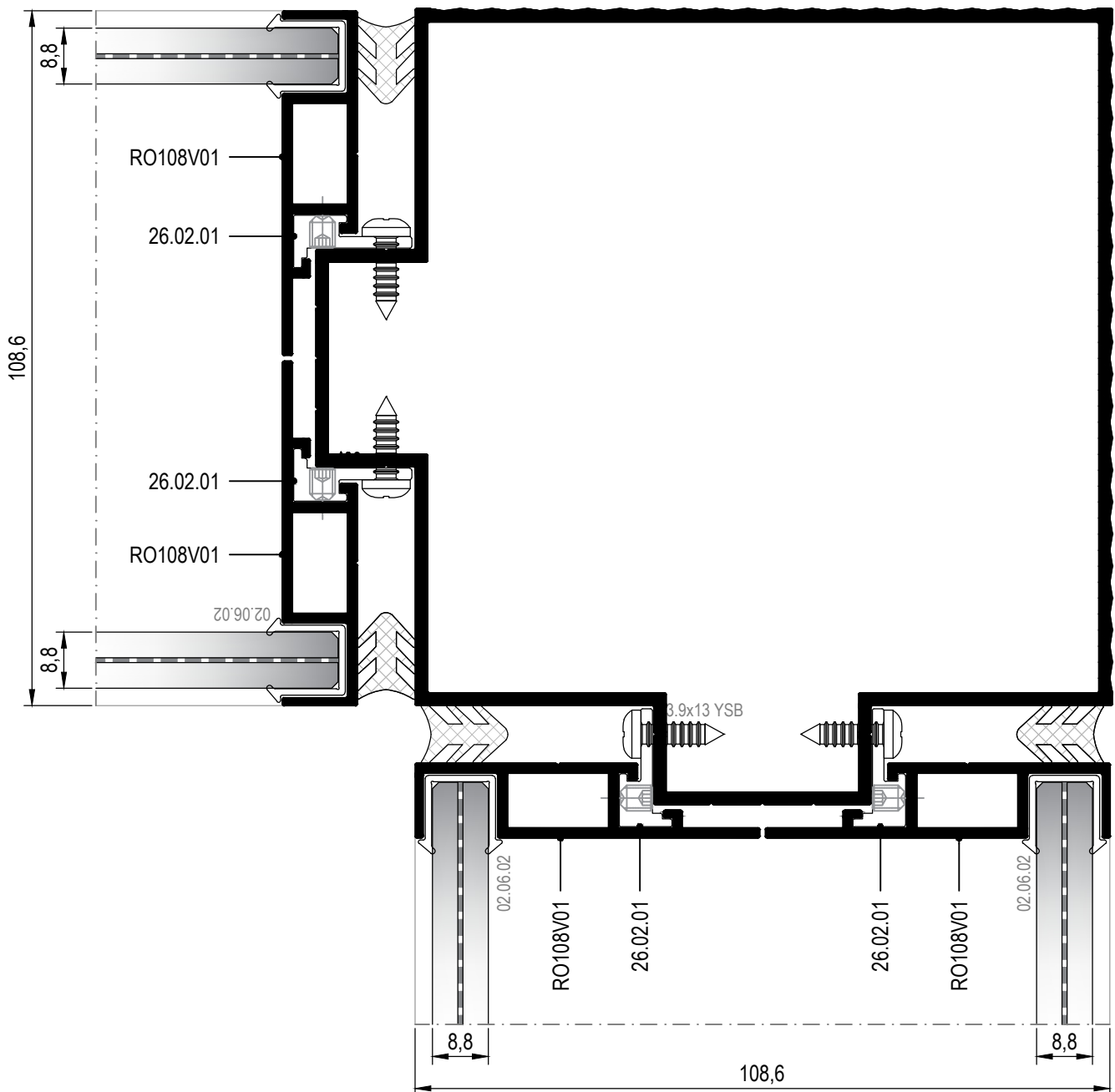

35 DETAYI
DETAIL

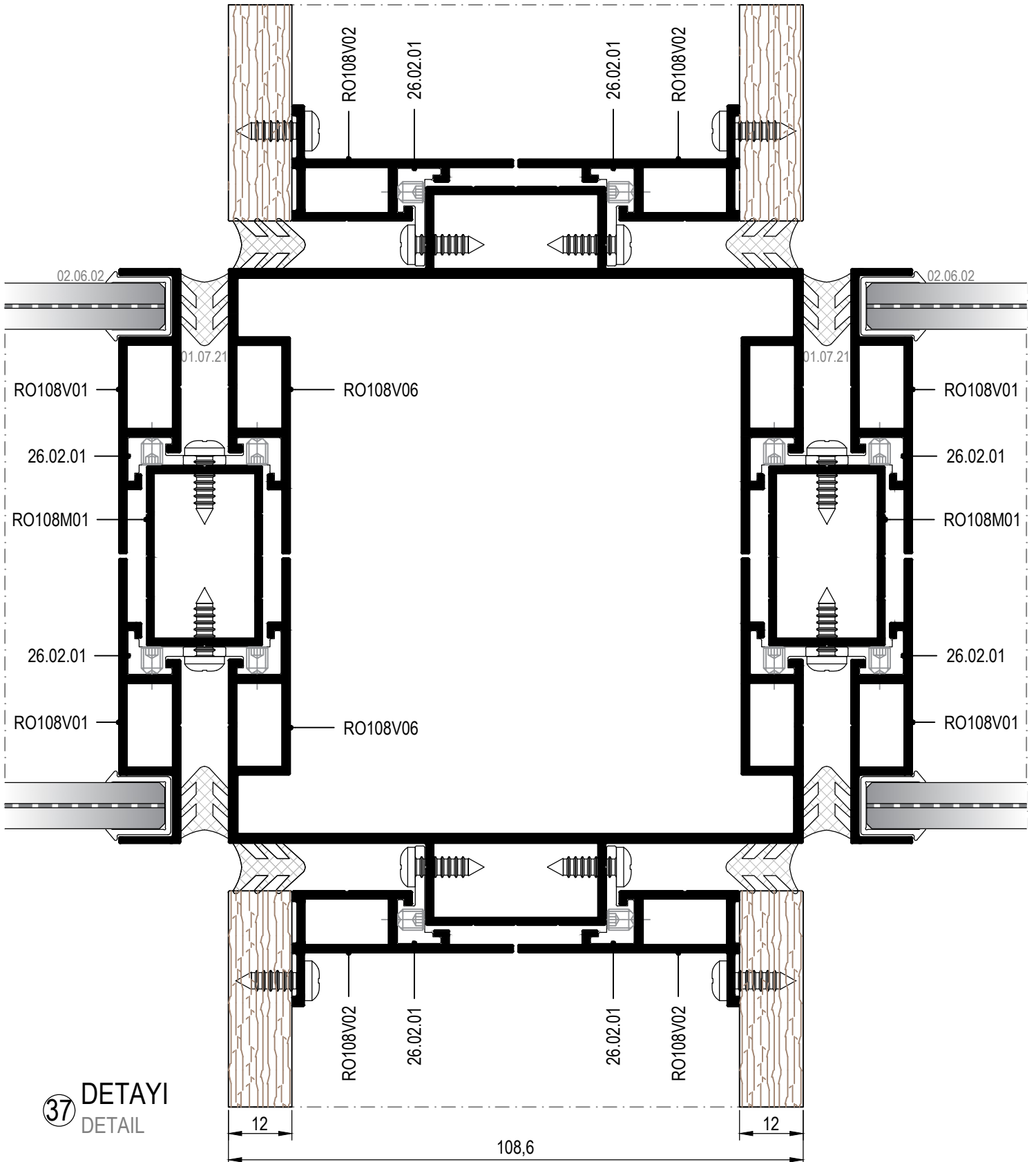

37 DETAYI
DETAIL

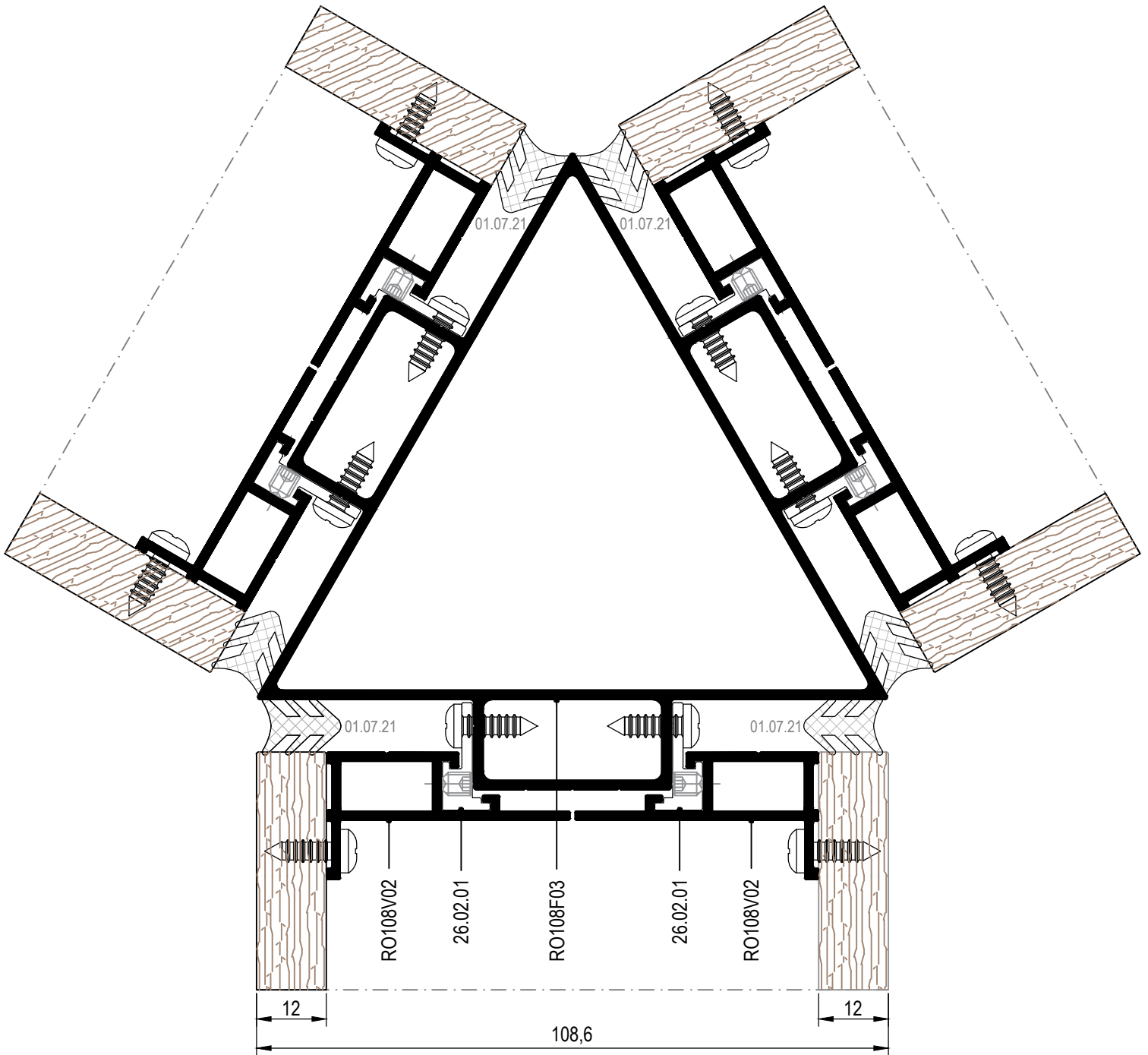

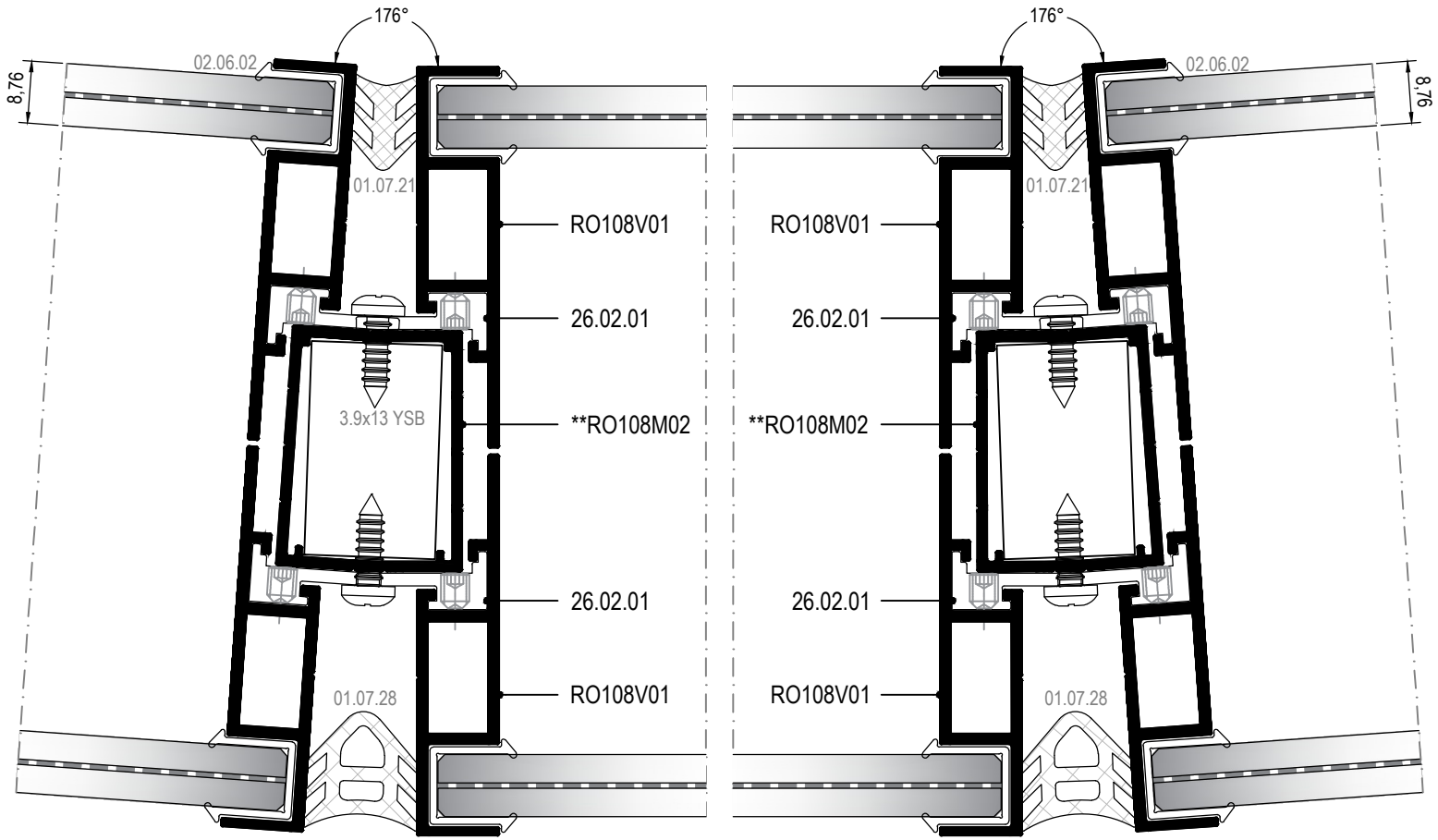

**Kalıp aktif değildir. Sipariş üzerine yapılacaktır.
The die is not active. It will be produced by order.







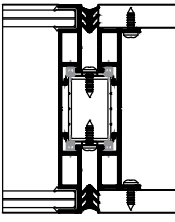

MİMARİ KATALOG
ARCHITECTURAL CATALOGUE

Alüminyum Konvansiyonel Sistemleri
Aluminium Conventional Systems

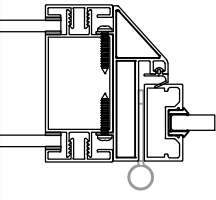
RO108

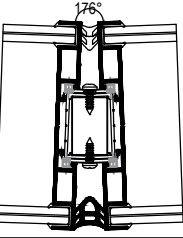
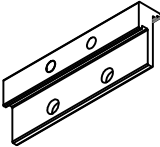

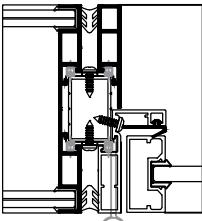
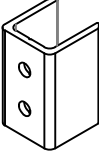

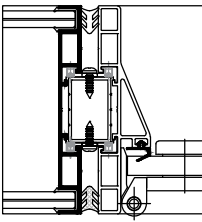
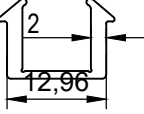
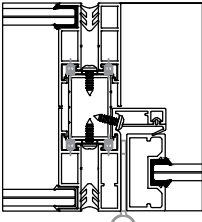
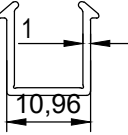
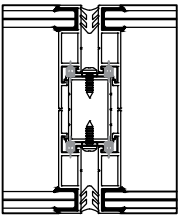
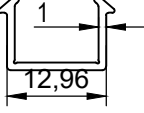
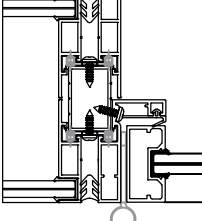

AKSESUARLAR

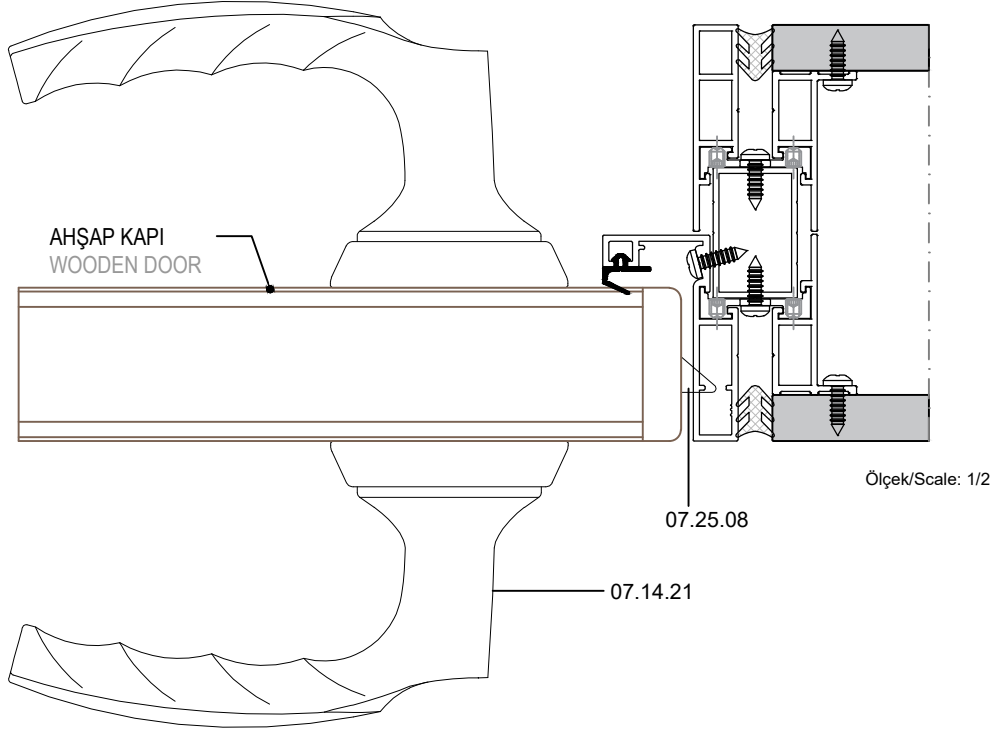
ACCESSORIES

	<p>01.07.21 DERZ FİTİLİ LAP JOINT GASKET</p> <p>Malzeme / Material : EPDM Ağırlık / Weight : 125 gr/m Paket / Package: 120 m / 15 kg</p>			<p>15.02.22 KAPI MENTEŞESİ HINGE FOR DOOR</p>	
	<p>01.07.28 DERZ FİTİLİ LAP JOINT GASKET</p> <p>Malzeme / Material : EPDM Ağırlık / Weight : 170 gr/m Paket / Package: 88 m / 15 kg</p>			<p>26.02.01 KİLİTLEME PROFİLİ LOCKING PROFILE</p> <p>Malzeme / Material : ALÜMİNYUM+SETSKUR+VİDA</p>	
	<p>01.18.53 İÇ BİNİ FİTİLİ INNER ACOUSTICAL GASKET</p> <p>Malzeme / Material : EPDM Ağırlık / Weight : 56 gr/m Paket / Package: 267 m / 15 kg</p>			<p>26.02.02 BAĞLANTI PROFİLİ CONNECTION PROFILE</p> <p>Malzeme / Material : ALÜMİNYUM</p>	
	<p>01.18.58 DIŞ BİNİ FİTİLİ OUTER ACOUSTICAL GASKET</p> <p>Malzeme / Material : EPDM Ağırlık / Weight : 43 gr/m Paket / Package: 348 m / 15 kg</p>				
	<p>02.06.01 CAM FİTİLİ 8-8,76mm cam için GASKET for 8-8,76 mm glass thickness</p> <p>Malzeme / Material : ŞEFFAF PVC TRANSPARENT PVC Paket / Package: 100 mt.</p>				
	<p>02.06.02 CAM FİTİLİ 8-8,76mm cam için GASKET for 8-8,76 mm glass thickness</p> <p>Malzeme / Material : ŞEFFAF PVC TRANSPARENT PVC Paket / Package: 100 mt.</p>				
	<p>02.06.03 CAM FİTİLİ 10-10,76mm cam için GASKET for 10-10,76 mm glass thickness</p> <p>Malzeme / Material : ŞEFFAF PVC TRANSPARENT PVC Paket / Package: 100 mt.</p>				







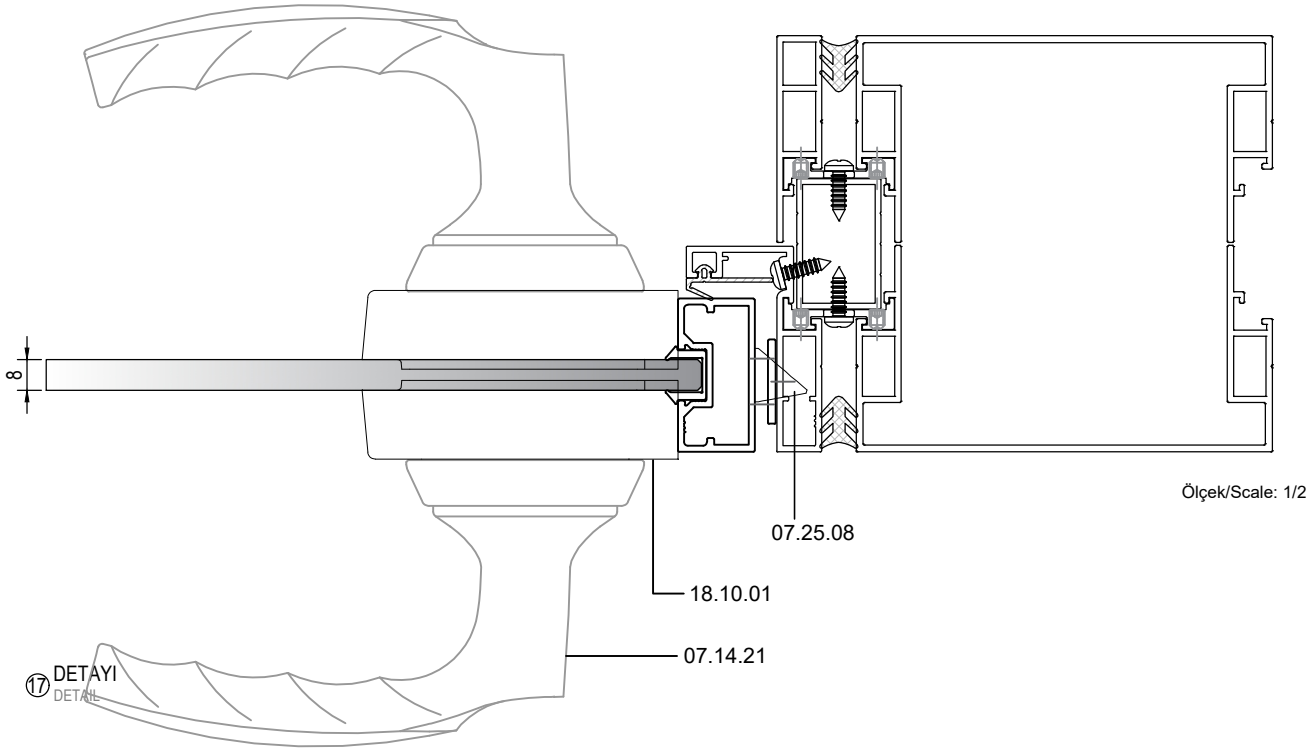

ALÜMİNYUM KASA AHŞAP KAPI DETAYI İÇİN / WOOD DOOR WITH ALUMINIUM FRAME DETAIL



KOD CODE	AÇIKLAMA DESCRIPTION	ALTERNATİF 1 ALTERNATIVE 1	ALTERNATİF 2 ALTERNATIVE 2
 07.14.21	HOPPE ATLANTA KAPI KOLU HOPPE ATLANTA DOOR HANDLE	1	1
 07.25.08	HOPPE HCS DİL SETİ HOPPE MORTISE LOCKING SET	1	1
 18.02.30	HOPPE KASA KARŞILIĞI HOPPE STRIKER FOR FRAME	1	1
 18.04.28	HOPPE ÇİFTLİ KİLİT SİLİNDİRİ HOPPE DOUBLE LOCK CYLINDER	1	--
 18.04.29	HOPPE TEKLİ KİLİT SİLİNDİRİ HOPPE SINGLE LOCK CYLINDER	--	1
 18.04.30	HOPPE MANDAL HOPPE LATCH	--	1
 15.02.22	KAPI MENTEŞESİ HINGE FOR DOOR	3	3

ALÜMİNYUM KASA ALÜMİNYUM ÇERÇEVELİ CAM KAPI DETAYI İÇİN / GLASS DOOR WITH ALUMINIUM FRAME DETAIL







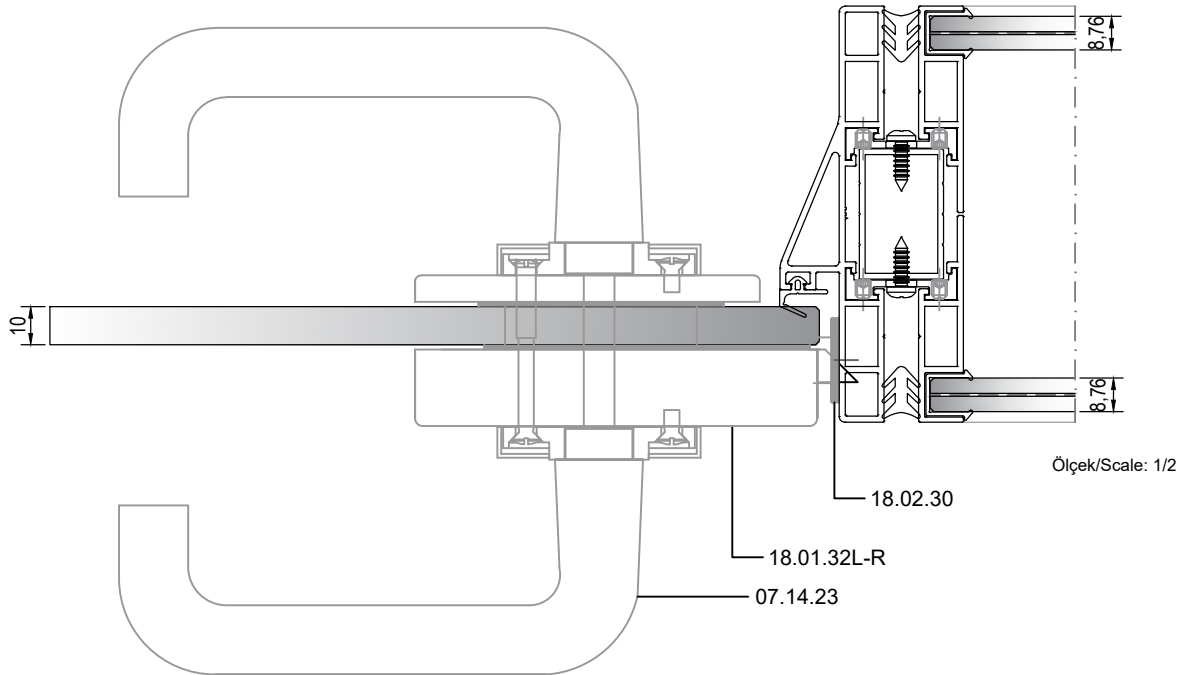
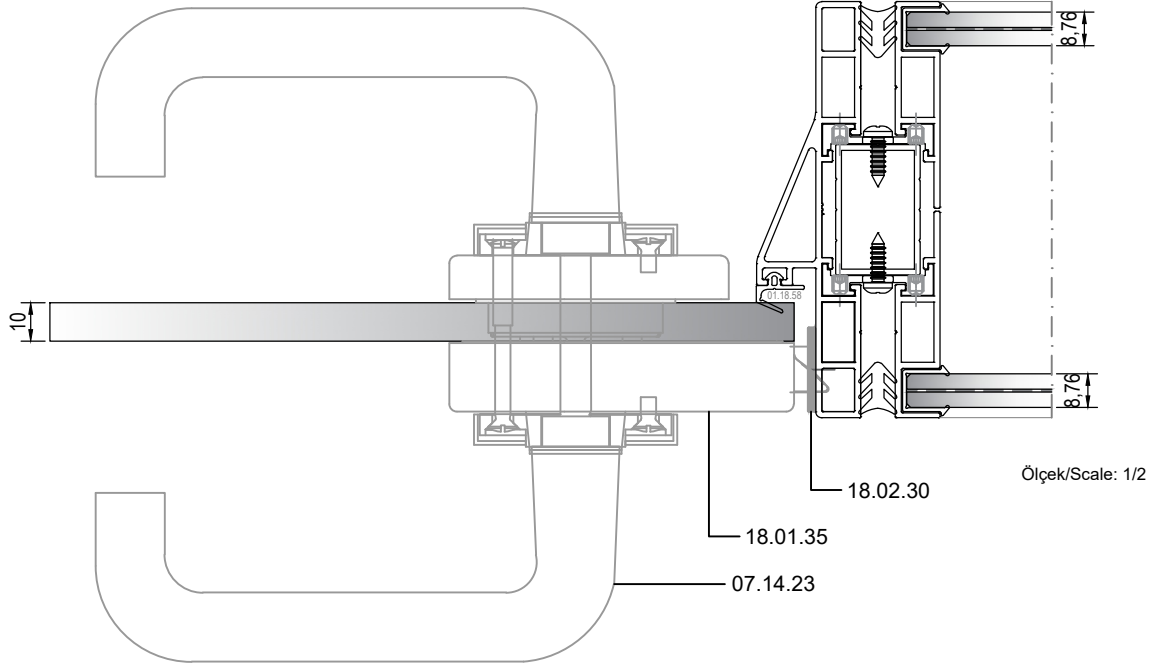



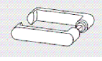



KOD CODE	AÇIKLAMA DESCRIPTION	ALTERNATİF 1 ALTERNATIVE 1	ALTERNATİF 2 ALTERNATIVE 2
 07.14.21	HOPPE ATLANTA KAPI KOLU HOPPE ATLANTA DOOR HANDLE	1	1
 07.25.08	HOPPE HCS DİL SETİ HOPPE MORTISE LOCKING SET	1	1
 18.02.30	HOPPE KASA KARŞILIĞI HOPPE STRIKER FOR FRAME	1	1
 18.10.01 veya / or	HOPPE CAM KAPI ADAPTÖRÜ HOPPE ADAPTER FOR GLASS DOOR	1	1
 18.10.02	YERLİ CAM KAPI ADAPTÖRÜ ADAPTER FOR GLASS DOOR		
 18.04.28	HOPPE ÇİFTLİ KİLİT SİLİNDİRİ HOPPE DOUBLE LOCK CYLINDER	1	–
 18.04.29	HOPPE TEKLİ KİLİT SİLİNDİRİ HOPPE SINGLE LOCK CYLINDER	–	1
 18.04.30	HOPPE MANDAL HOPPE LATCH	–	1
 15.02.22	KAPI MENTEŞESİ HINGE FOR DOOR	3	3

ALÜMİNYUM KASA CAM KAPI DETAYI İÇİN / GLASS DOOR WITH ALUMINIUM FRAME DETAIL



ALÜMİNYUM KASA CAM KAPI DETAYI İÇİN / GLASS DOOR WITH ALUMINIUM FRAME DETAIL

KOD CODE	AÇIKLAMA DESCRIPTION	1.ALTERNATİF 1.ALTERNATİF	2.ALTERNATİF 2.ALTERNATİF
 07.14.23	DORMA JUNIOR OFFICE KAPI KOLU DORMA JUNIOR OFFICE DOOR HANDLE	1	1
 07.14.24	DORMA STUDIO RONDO KAPI KOLU DORMA STUDIO RONDO DOOR HANDLE		
 18.01.32L	DORMA JUNIOR OFFICE KİLİT GÖVDE DORMA JUNIOR OFFICE LOCK	1	--
 18.01.32R	DORMA JUNIOR OFFICE KİLİT GÖVDE DORMA JUNIOR OFFICE LOCK	1	--
 18.01.33	DORMA STUDIO RONDO KİLİT GÖVDE DORMA STUDIO RONDO LOCK	--	1
 15.02.38	DORMA JUNIOR OFFICE MENTEŞE DORMA JUNIOR OFFICE MENTEŞE	1	1
 18.02.30	HOPPE KASA KARŞILIĞI HOPPE STRIKER FOR FRAME	1	1
 18.04.27	DORMA BAREL 61mm DORMA CYLINDER 61mm	1	1
 18.04.07	KALE BAREL 62mm KALE CYLINDER 62mm		

KOD CODE	AÇIKLAMA DESCRIPTION	ALTERNATİF 1 ALTERNATIVE 1	ALTERNATİF 2 ALTERNATIVE 2	TAŞIMA KAP. LOAD CAPACITY
 18.01.41	KAHE CAM KAPI KOLLU KİLİT-ELOKSALLI KAHE GLASS DOOR HANDLE LOCK-ANODIZING	1	--	
 15.02.46	KAHE CAM DUVAR YAYSIZ MENTEŞE KAHE GLASS TO WALL UNSPRUNG HINGE	3	--	30 kg
 18.01.42	KAHE CAM KAPI KOLLU KİLİT-INOX KAHE GLASS DOOR HANDLE LOCK-INOX	--	1	
 15.02.45	KAHE CAM DUVAR YAYSIZ MENTEŞE KAHE GLASS TO WALL UNSPRUNG HINGE	--	3	45 kg

** 18.01.41 VE 18.01.42 KODLU KİLİTLERİN İÇERİSİNDE ALÜMİNYUM BAREL VE KARŞILIK MEVCUTTUR.
** THE 18.01.41 AND 18.01.42 LOCKS CONTAIN AND ALUMINIUM CYLINDER AND STRIKER.



07.14.21

HOPPE ATLANTA KAPI KOLU
HOPPE ATLANTA DOOR HANDLE

Renk / Colour : Siyah-Gri
Black-Grey

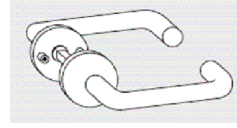

07.14.23

DORMA JUNIOR OFFICE KAPI KOLU
DORMA JUNIOR OFFICE DOOR HANDLE

Renk / Colour : Siyah-Gri
Black-Grey

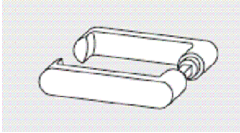

07.14.24

DORMA STUDIO RONDO KAPI KOLU
DORMA STUDIO RONDO DOOR HANDLE

Renk / Colour : Siyah-Gri
Black-Grey



07.25.08

HOPPE HCS DİL SETİ
HOPPE MORTISE LOCKING SET

Renk / Colour : Paslanmaz çelik



18.10.01

HOPPE CAM KAPI ADAPTÖRÜ
HOPPE ADAPTER FOR GLASS DOOR

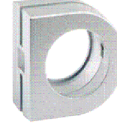

18.10.02

YERLİ CAM KAPI ADAPTÖRÜ
ADAPTER FOR GLASS DOOR



18.04.28

HOPPE ÇİFTLİ KİLİT SİLİNDİRİ
HOPPE DOUBLE LOCK CYLINDER



18.02.30

HOPPE KASA KARŞILIĞI
HOPPE STRIKER FOR FRAME



18.04.29

HOPPE TEKLİ KİLİT SİLİNDİRİ
HOPPE SINGLE LOCK CYLINDER



18.04.30

HOPPE MANDAL
HOPPE LATCH

18.04.30 KODLU MANDAL İLE BİRLİKTE KULLANILMALIDIR.

18.04.29 KODLU SİLİNDİR İLE BİRLİKTE KULLANILMALIDIR.

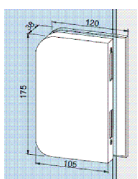

18.02.31L

DORMA JUNIOR OFFICE KİLİT KARŞILIĞI
DORMA JUNIOR OFFICE LOCKING STRIKER

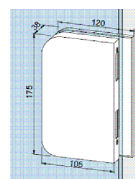

18.02.31R

DORMA JUNIOR OFFICE KİLİT KARŞILIĞI
DORMA JUNIOR OFFICE LOCKING STRIKER

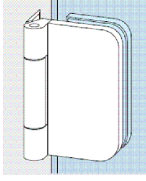

15.02.38

DORMA JUNIOR OFFICE MENTEŞE
DORMA JUNIOR OFFICE HINGE

Renk / Colour : Siyah-Gri
Black-Grey

Kapı ağırlığı maks. 55 kg (Door weight max. 55 kg)
Kanat genişliği maks. 1000 mm (Door sash width max. 1000 mm)



15.02.22

KAPI MENTEŞESİ
HINGE FOR DOOR

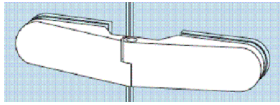

15.02.39L

DORMA STUDIO RONDO MENTEŞE-SOL
DORMA STUDIO RONDO HINGE-LEFT

Renk / Colour : Siyah-Gri
Black-Grey

Kapı ağırlığı maks.45 kg ve 2 adet menteşe kullanılmalı. (Should be used 2 for max 45 kg door.)
8 / 10 mm temperli cam kullanılabilir. (8/10mm tempered glass can be used.)

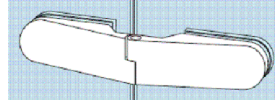

15.02.39R

DORMA STUDIO RONDO MENTEŞE-SAĞ
DORMA STUDIO RONDO HINGE-RIGHT

Renk / Colour : Siyah-Gri
Black-Grey

Kapı ağırlığı maks.45 kg ve 2 adet menteşe kullanılmalı. (Should be used 2 for max 45 kg door.)
8 / 10 mm temperli cam kullanılabilir. (8/10mm tempered glass can be used.)

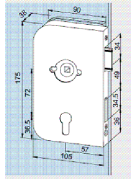

18.01.32L

DORMA JUNIOR OFFICE KİLİT GÖVDE-SOL
DORMA JUNIOR OFFICE LOCK-LEFT

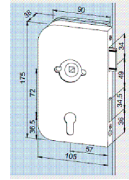

18.01.32R

DORMA JUNIOR OFFICE KİLİT GÖVDE-SAĞ
DORMA JUNIOR OFFICE LOCK-RIGHT

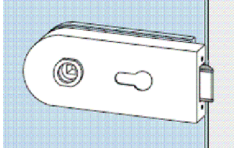

18.01.33

DORMA STUDIO RONDO KİLİT GÖVDE
DORMA STUDIO RONDO LOCK

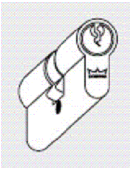

18.04.27

DORMA BAREL
DORMA CYLINDER

61mm= 25,5 + 10 + 25,5mm

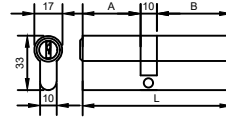

18.04.07

KALE BAREL
KALE CYLINDER

A	B	L
26	26	62



18.01.41

KAHE CAM KAPI KOLLU KİLİT
KAHE GLASS DOOR HANDLE LOCK

Renk / Colour : Eoksalli / Anodizing
Alüminyum barel ve karşılık dahildir.

18.01.41 kodlu kilitin içerisinde Alüminyum barel ve karşılık mevcuttur.
The 18.01.41 lock contains Aluminium cylinder and striker.



18.01.42

KAHE CAM KAPI KOLLU KİLİT
KAHE GLASS DOOR HANDLE LOCK

Renk / Colour : INOX

18.01.42 kodlu kilitin içerisinde Alüminyum barel ve karşılık mevcuttur.
The 18.01.42 lock contains Aluminium cylinder and striker.



15.02.46

KAHE CAM DUVAR YAYSIZ MENTEŞE
KAHE GLASS TO WALL UNSPRUNG HINGE



15.02.45

KAHE CAM DUVAR YAYSIZ MENTEŞE
KAHE GLASS TO WALL UNSPRUNG HINGE