

MİMARİ KATALOG ARCHITECTURAL CATALOGUE

Alüminyum Cephe Sistemleri
Aluminium Facade Systems

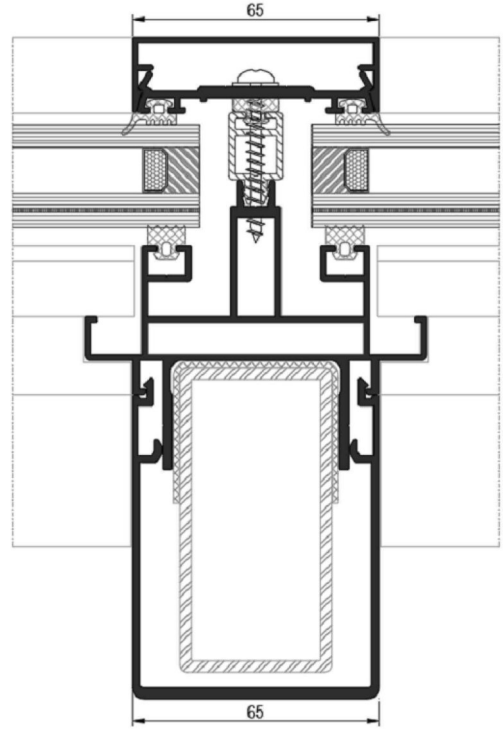

SKY 65

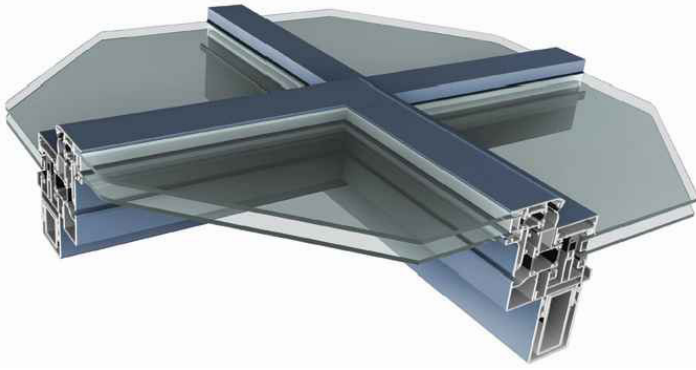

TEKNİK ÖZELLİKLERİ / TECHNICAL PROPERTIES

PROFİL GENİŞLİĞİ / PROFILE WIDTH	65 mm
DİKME DERİNLİKLERİ / MULLION DEPTHS	min. 76,17mm - max. 80mm
KAYIT DERİNLİKLERİ / TRANSOM DEPTHS	min. 15mm - max. 82,1mm
PROFİL ET KALINLIĞI / PROFILE WALL THICKNESS	1,5/1,8/2/2,5 mm
MAX. CAM KALINLIĞI / MAX. GLASS THICKNESS	27mm
ISI BARIYERLERİ / THERMAL INSULATION BAR	14,8/24mm

KULLANIM SEÇENEKLERİ / APPLICATION ALTERNATIVES

KAPAKLI CEPHE / FACADE WITH CAP	•
YARI KAPAKLI CEPHE / TWO SIDE	•
DIŞA AÇILIM GİZLİ KANAT / OUTWARD OPENING HIDDEN VENT	•
ÇELİK TAKVİYELİ SİSTEM / STEEL REINFORCEMENT SYSTEM	•

MİMARİ KATALOG
ARCHITECTURAL CATALOGUE

Alüminyum Cephe Sistemleri
Aluminium Facade Systems

SKY65

PROFİLLER

PROFILES

KOD / CODE	AĞIRLIK (kg/m) / WEIGHT	Jxx cm4	Jyy cm4	Wx cm3	Wy cm3	L m	
R50M16	1,972	40,203	21,856	----	----	6	
R50T11	2,085	44,694	22,469	----	----	6	

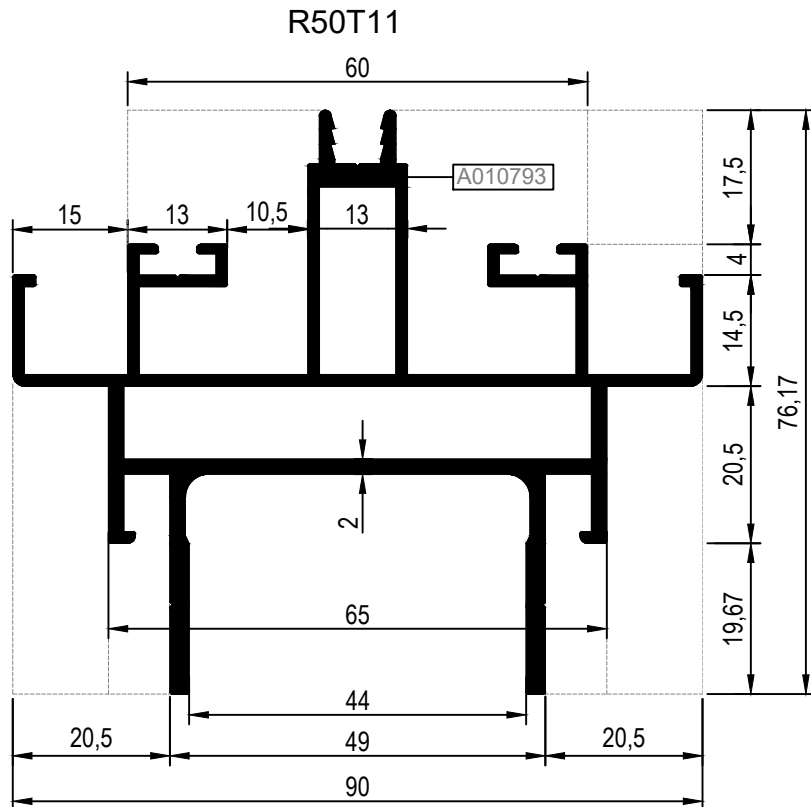
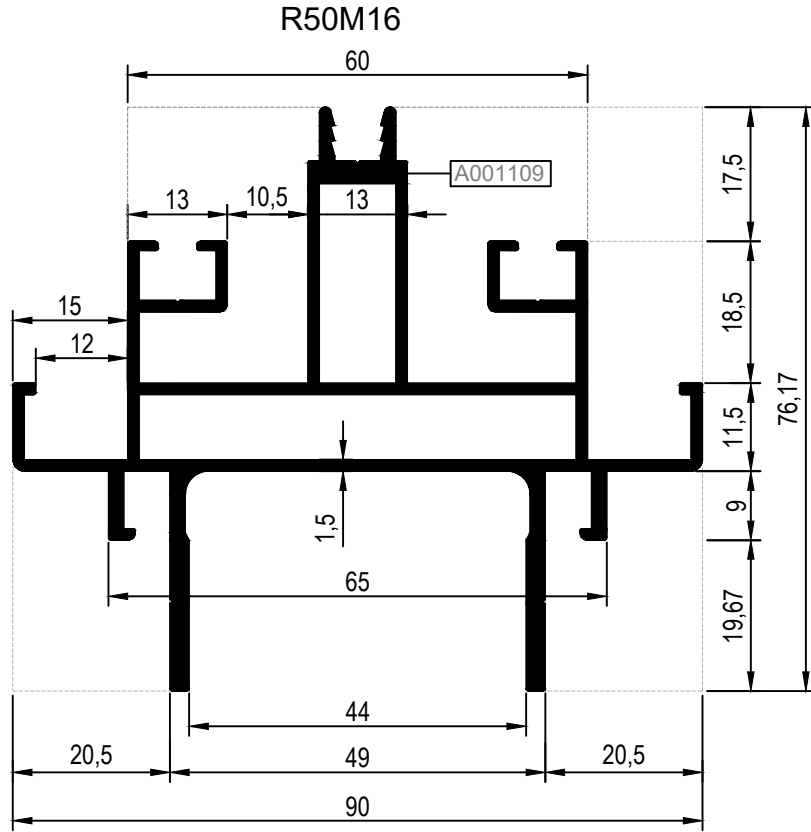

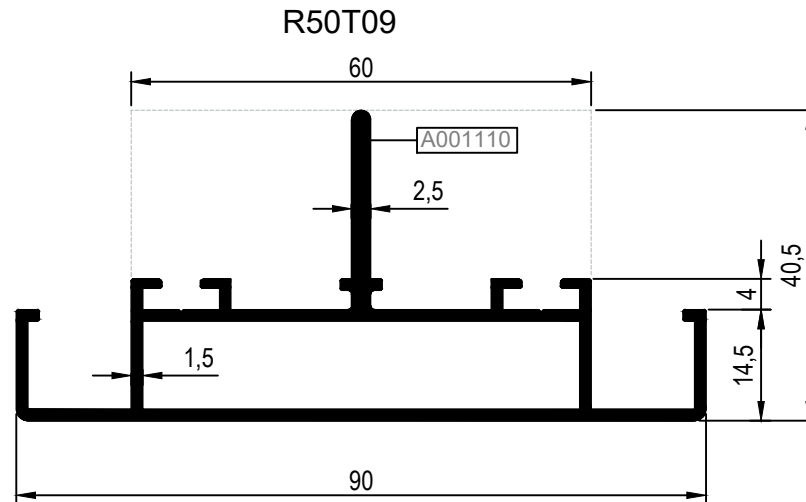
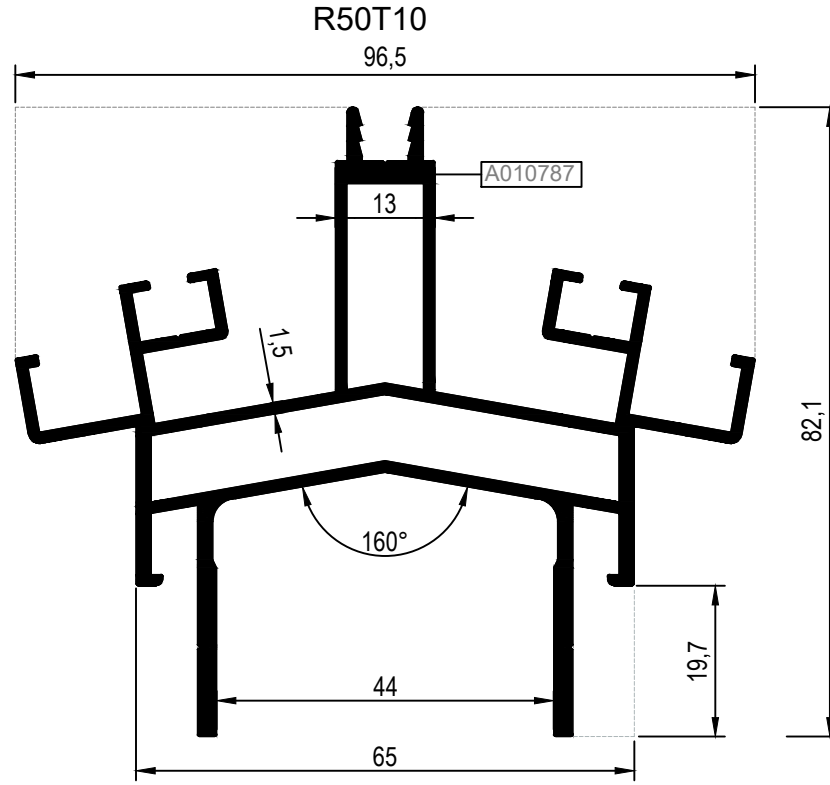

KOD / CODE	AĞIRLIK (kg/m) / WEIGHT	Jxx cm4	Jyy cm4	Wx cm3	Wy cm3	L m	
R50T10	2,077	47,190	25,938	----	----	6	
R50T09	1,101	25,071	3,889	----	----	6	

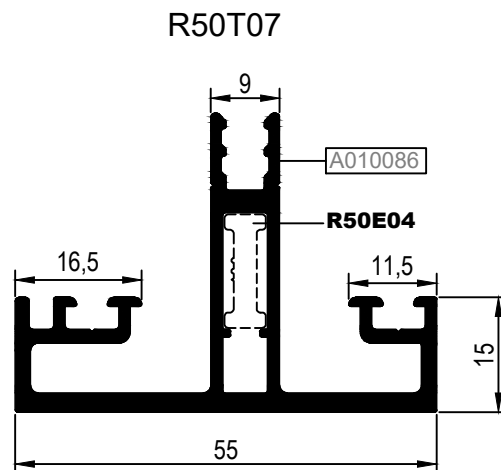
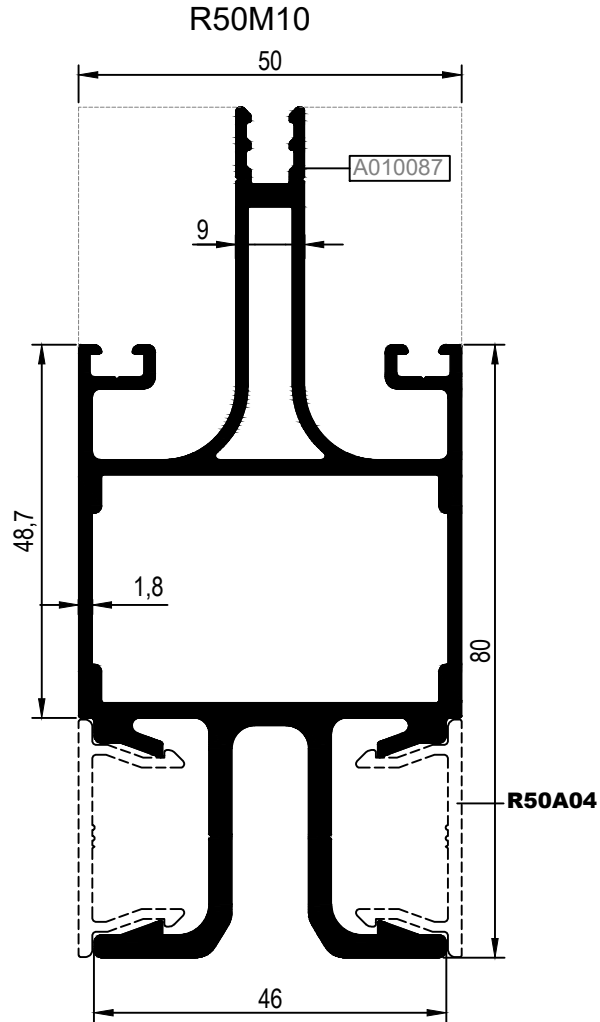

KOD / CODE	AĞIRLIK (kg/m) / WEIGHT	Jxx cm ⁴	Jyy cm ⁴	Wx cm ³	Wy cm ³	L m	
R50M10	2,565	21,713	86,773	----	----	6	
R50T07	1,052	9,560	4,362	----	----	6	

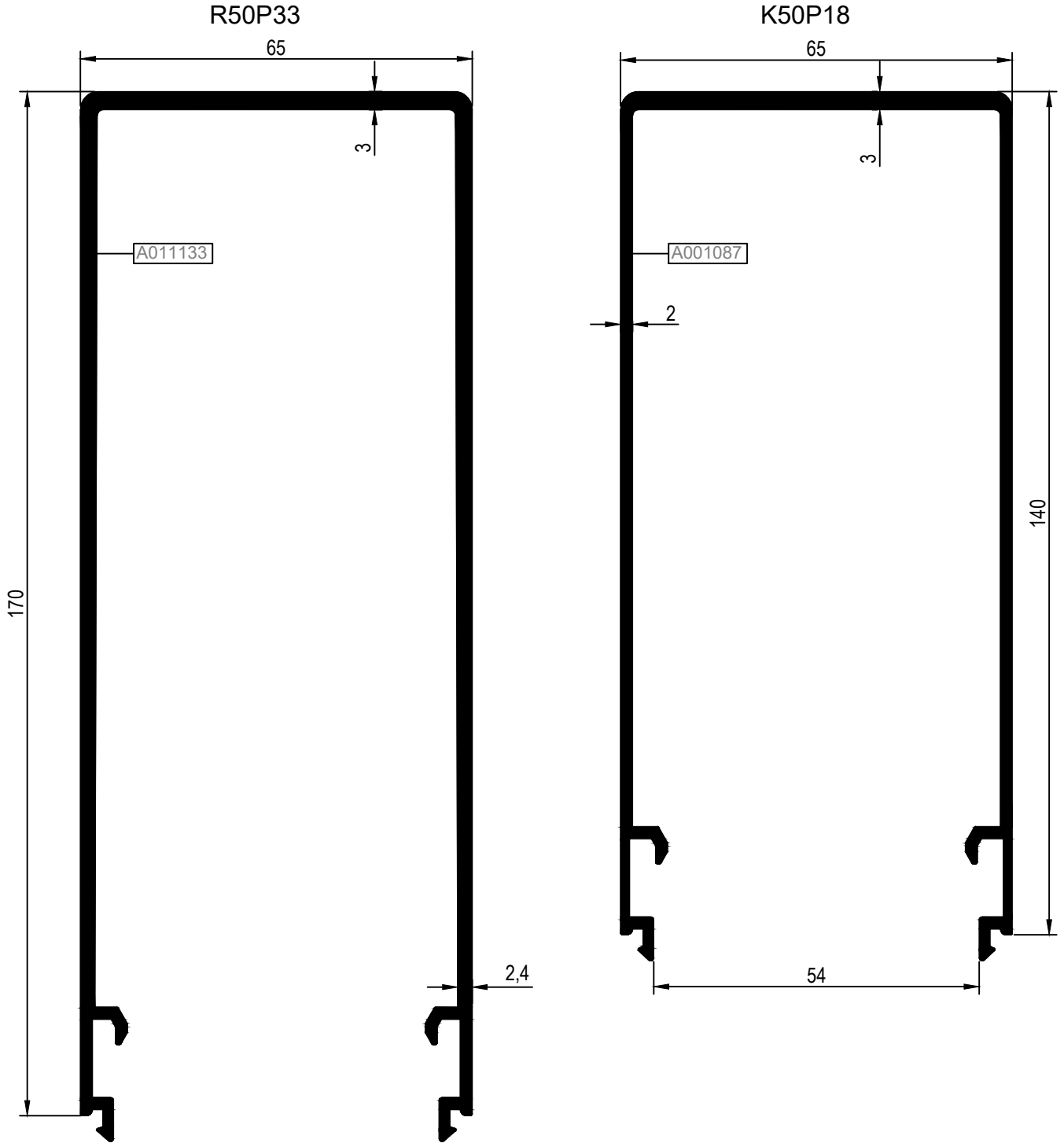

KOD / CODE	AĞIRLIK (kg/m) / WEIGHT	L m	KOD / CODE	AĞIRLIK (kg/m) / WEIGHT	L m
R50P33	2,997	6			
K50P18	2,313	6			



KOD / CODE	AĞIRLIK (kg/m) / WEIGHT	L m	KOD / CODE	AĞIRLIK (kg/m) / WEIGHT	L m
K50P19	1,336	6			
K50P20	0,901	6			

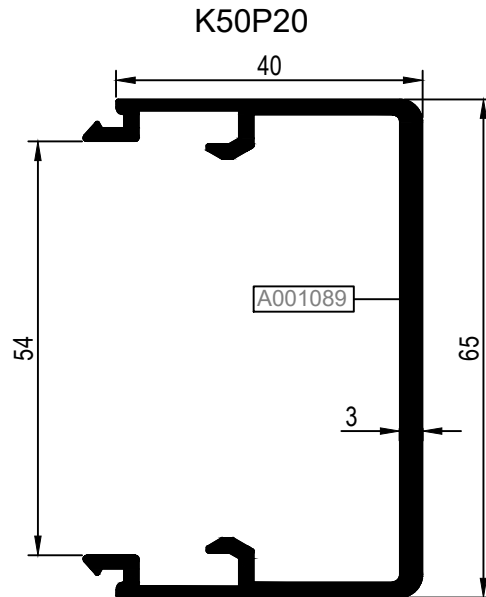
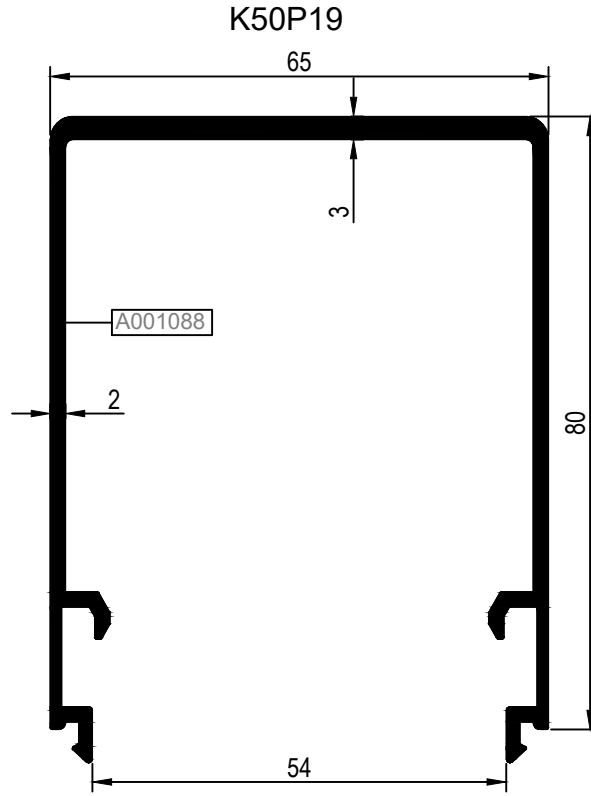
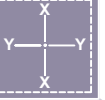

KOD / CODE	AĞIRLIK (kg/m) / WEIGHT	L m	KOD / CODE	AĞIRLIK (kg/m) / WEIGHT	L m
R50P05	0,566	6	R50A04	0,245	6
R50P04	0,455	6	R50E04	0,146	6
R50P21	0,872	6	R50S03	0,362	6
R50P22	0,580	6			

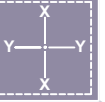

R50P05

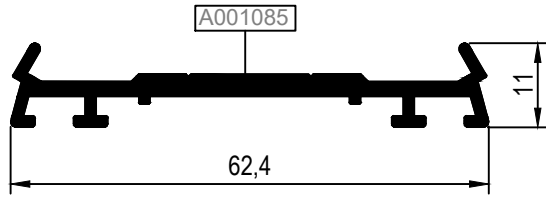

R50P04

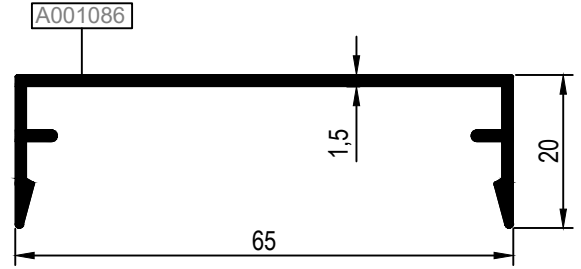

R50P21

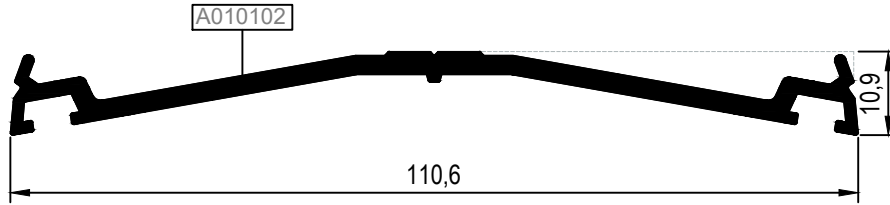

R50P22

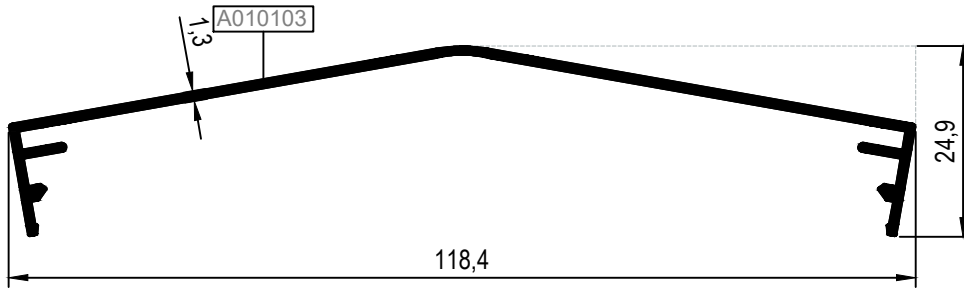

R50S03

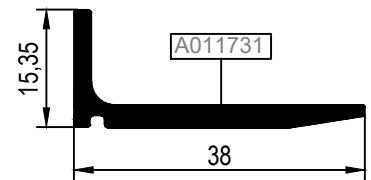

R50A04

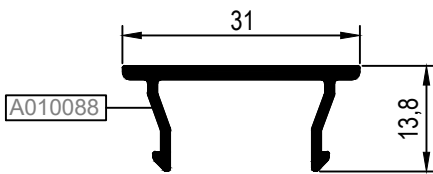

R50E04

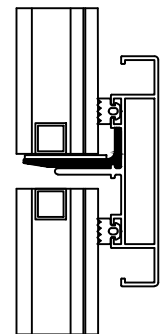
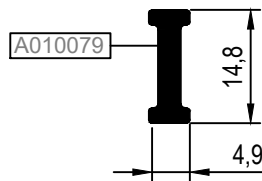

Ölçek/Scale: 1/2





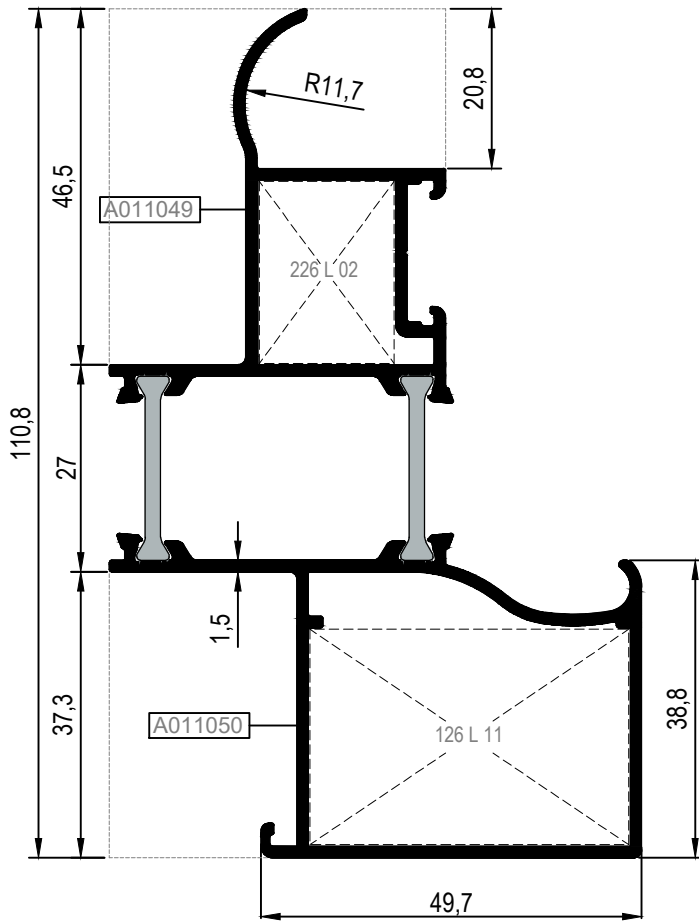

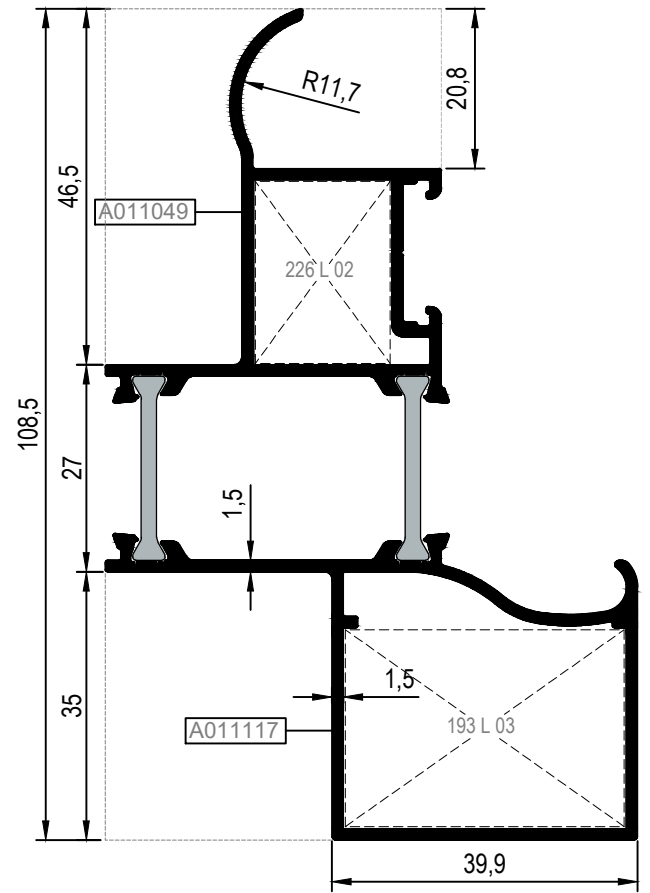

KOD / CODE	AĞIRLIK (kg/m) / WEIGHT	Jxx cm4	Jyy cm4	Wx cm3	Wy cm3	L m	
AR50M22	1,728	----	----	----	----	6	
AR50M23	1,660	----	----	----	----	6	

AR50M22



AR50M23



Nr	KÖŞE BAĞLANTI PROFİLİ PROFİL KOD NUMARASI		KÖŞE BAĞLANTI PROFİLİ PARÇA KOD NUMARASI		KESİM ÖLÇÜSÜ
AR50M22	A011049	A002020 (25L02)		226 L 02	 23,8 mm
	A011050	A002126 (25L11)		126 L 11	 28,1 mm
AR50M23	A011049	A002020 (25L02)		226 L 02	 23,8 mm
	A011117	A002021 (25L03)		193 L 03	 25,9 mm

KOD / CODE	AĞIRLIK (kg/m) / WEIGHT	Jxx cm4	Jyy cm4	Wx cm3	Wy cm3	L m	
AR50V20	1,216	----	----	----	----	6	
R50R12	0,643	----	----	----	----	6	

AR50V20

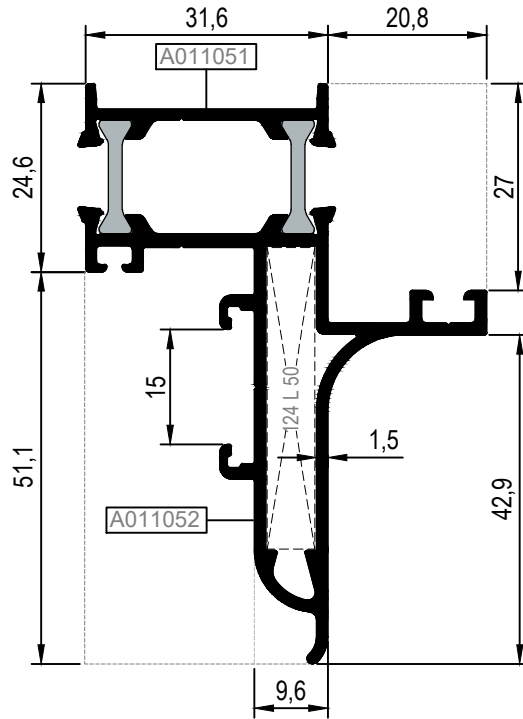

R50R12

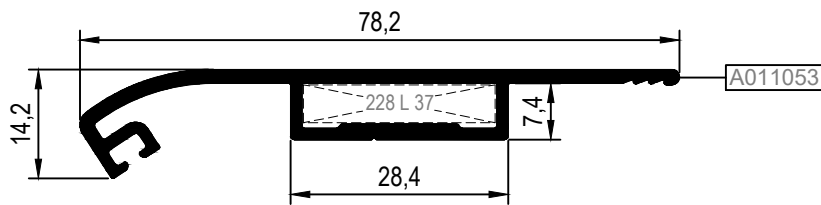

Nr	KÖŞE BAĞLANTI PROFİLİ PROFİL KOD NUMARASI		KÖŞE BAĞLANTI PROFİLİ PARÇA KOD NUMARASI	KESİM ÖLÇÜSÜ
AR50V20	A011052	A010838 (25L50)	124 L 50	39,3 mm
R50R12	A011053	A002398 (25L37)	228 L 37	5,1 mm

PROFİL KODU (PROFILE CODE)	25L02	25L03	25L11	25L37
FABRİKA KODU(FACTORY CODE)	A002020	A002021	A002126	A002398
AĞIRLIK (WEIGHT)	4,943 kg/m	4,315 kg/m	6,733 kg/m	7,971 kg/m
ÇİZİM (DRAWING)				

PROFİL KODU (PROFILE CODE)	25L50			
FABRİKA KODU(FACTORY CODE)	A010838			
AĞIRLIK (WEIGHT)	1,748 kg/m			
ÇİZİM (DRAWING)				

Nr			KESİM ÖLÇÜSÜ CUTTING SIZE		AKS. KODU ACS. CODE
AR50M22	A011049	25L02 (A002020)	23,8 mm	226 L 02	
	A011050	25L11 (A002126)	28,1 mm	126 L 11	
AR50M23	A011049	25L02 (A002020)	23,8 mm	226 L 02	
	A011117	25L03 (A002021)	25,9 mm	193 L 03	
AR50V20	A011052	25L50 (A010838)	39,3 mm	124 L 50	
R50R12	A011053	25L37 (A002398)	5,1 mm	228 L 37	

MİMARİ KATALOG
ARCHITECTURAL CATALOGUE

Alüminyum Cephe Sistemleri
Aluminium Facade Systems

SKY65

DETAYLAR

DETAILS

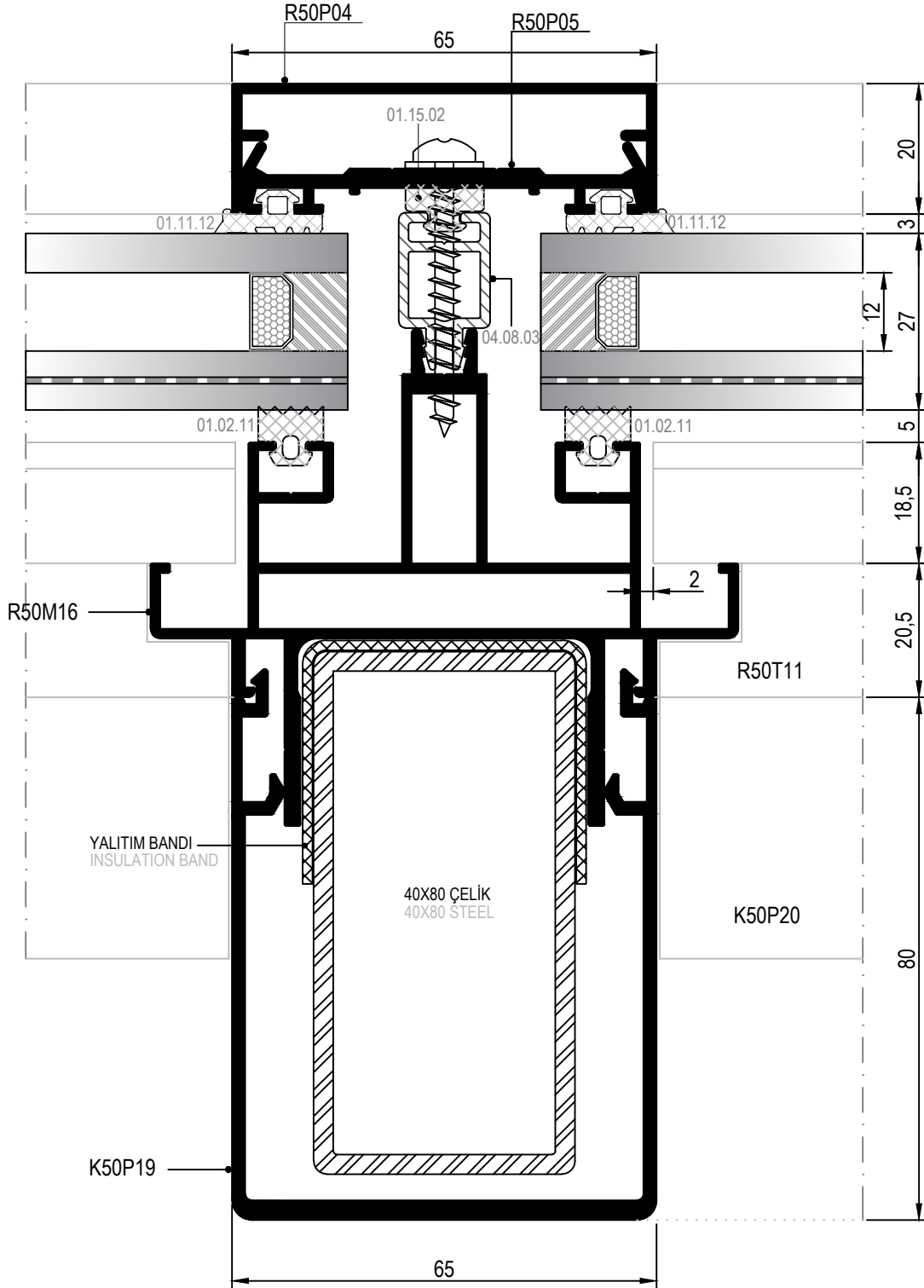
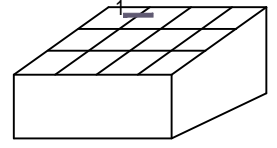

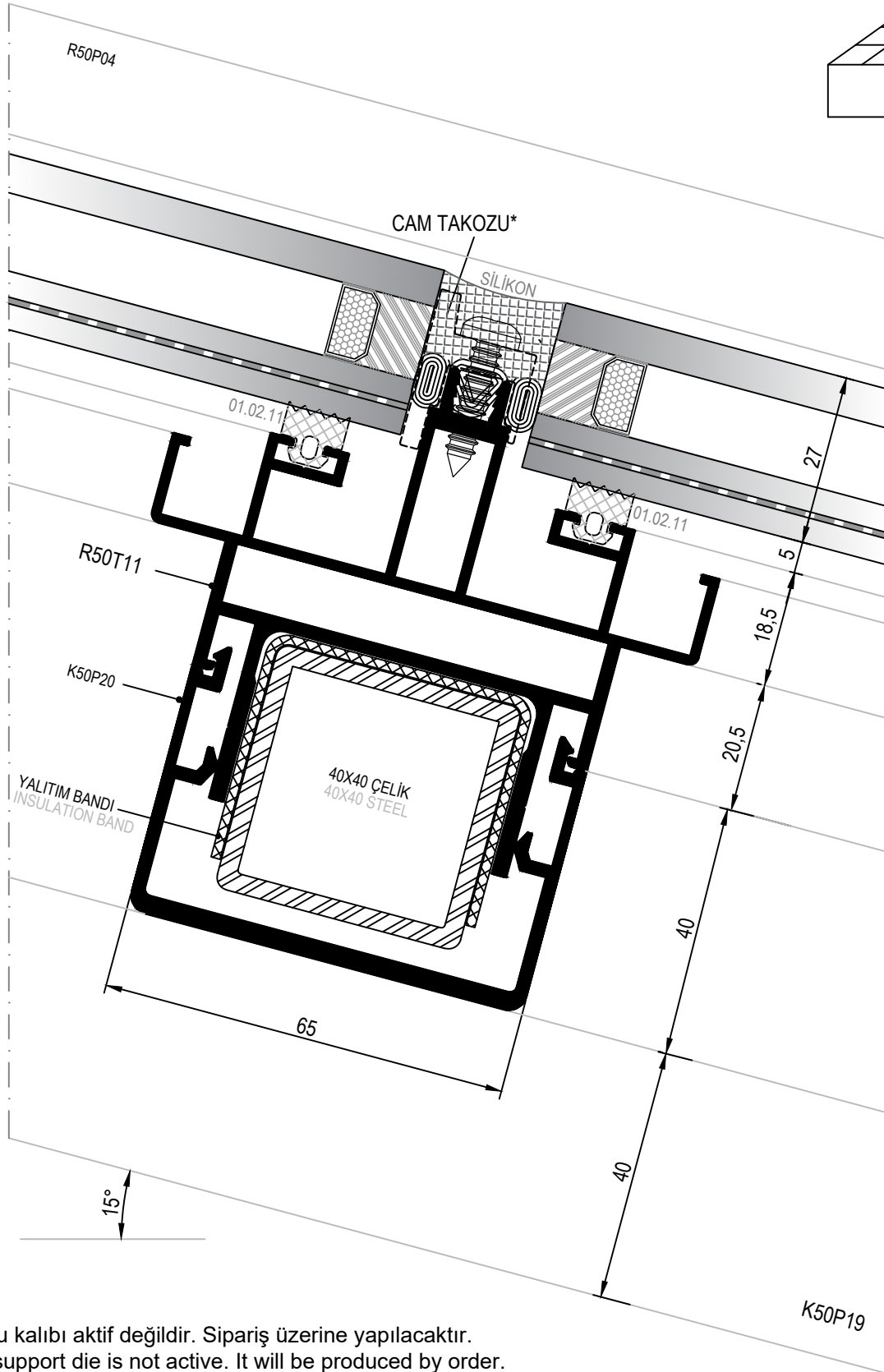

*Cam takozu kalıbı aktif değildir. Sipariş üzerine yapılacaktır.
*The glass support die is not active. It will be produced by order.

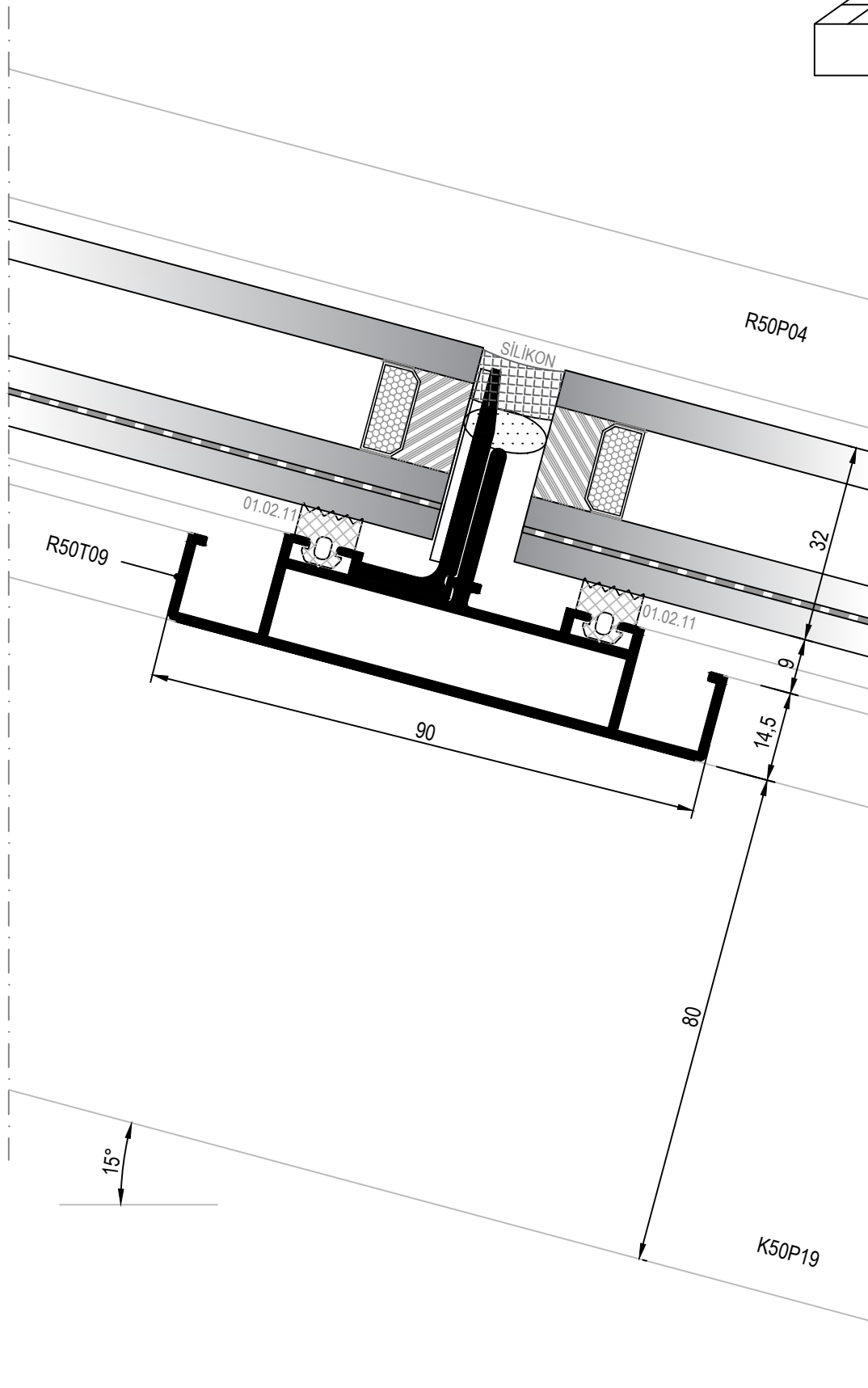
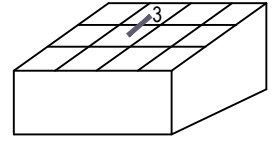

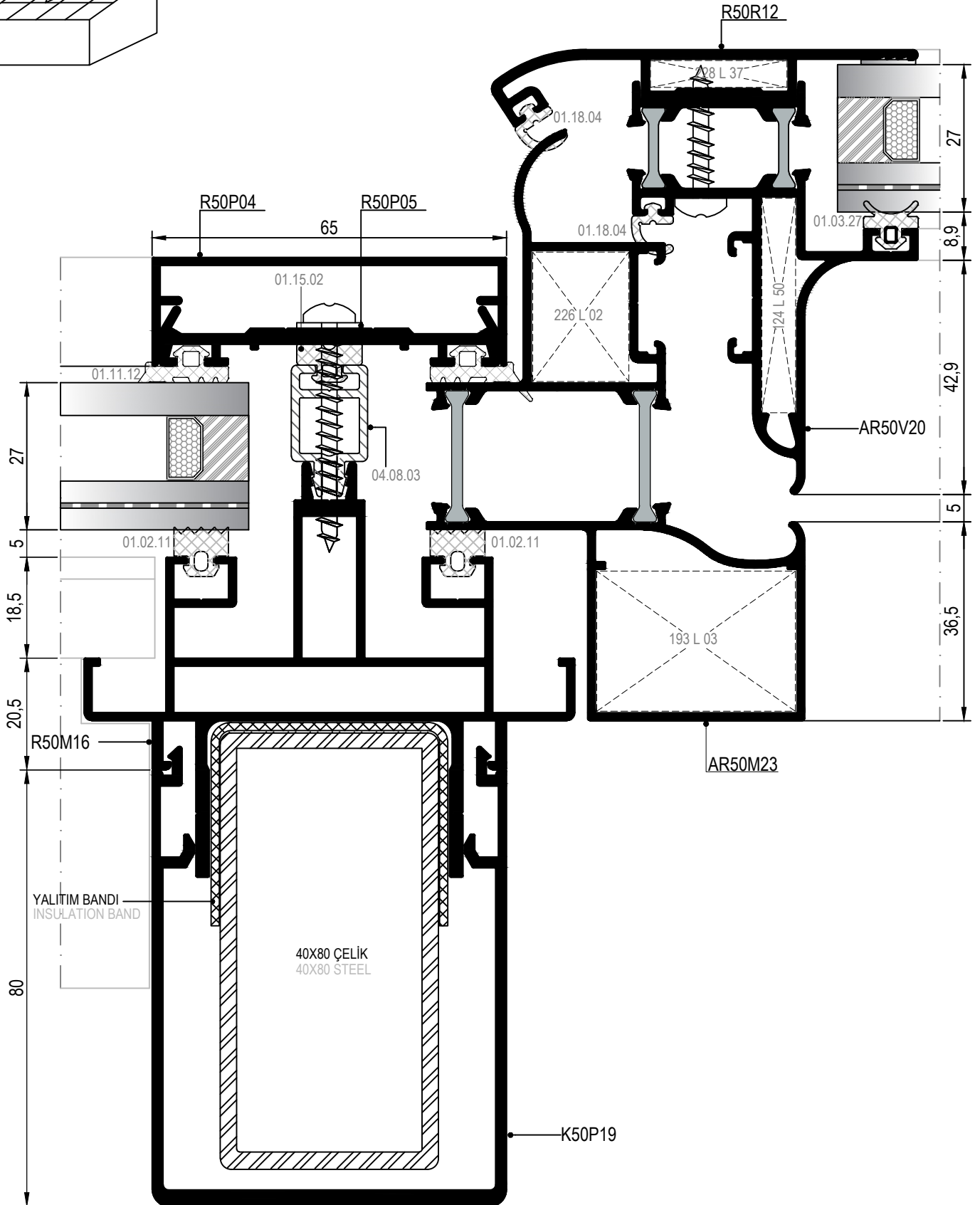
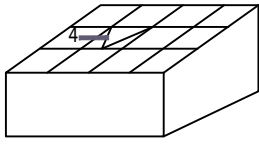

④ DETAY
DETAIL

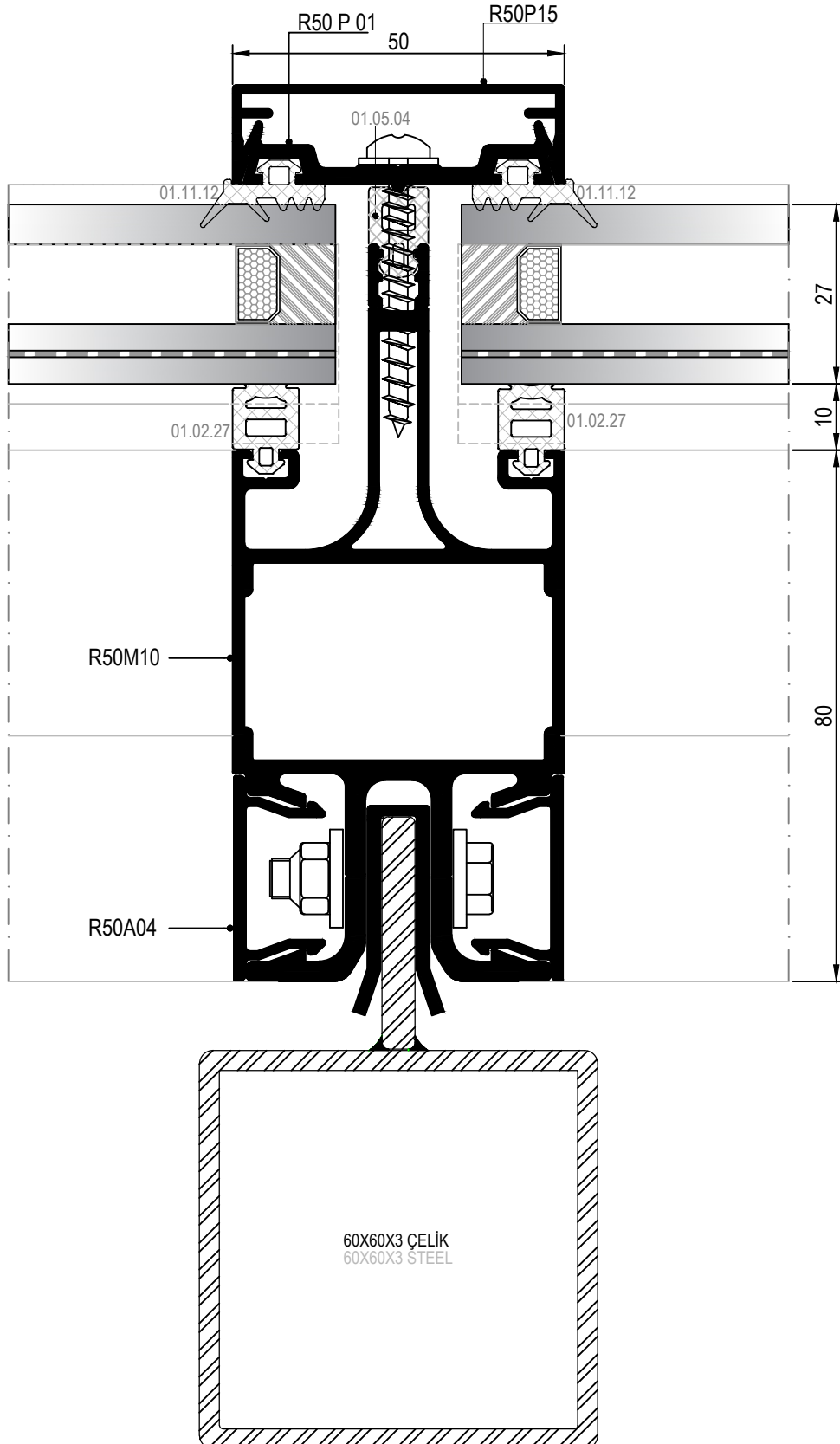
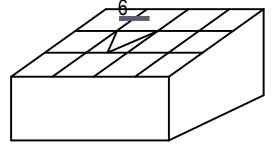

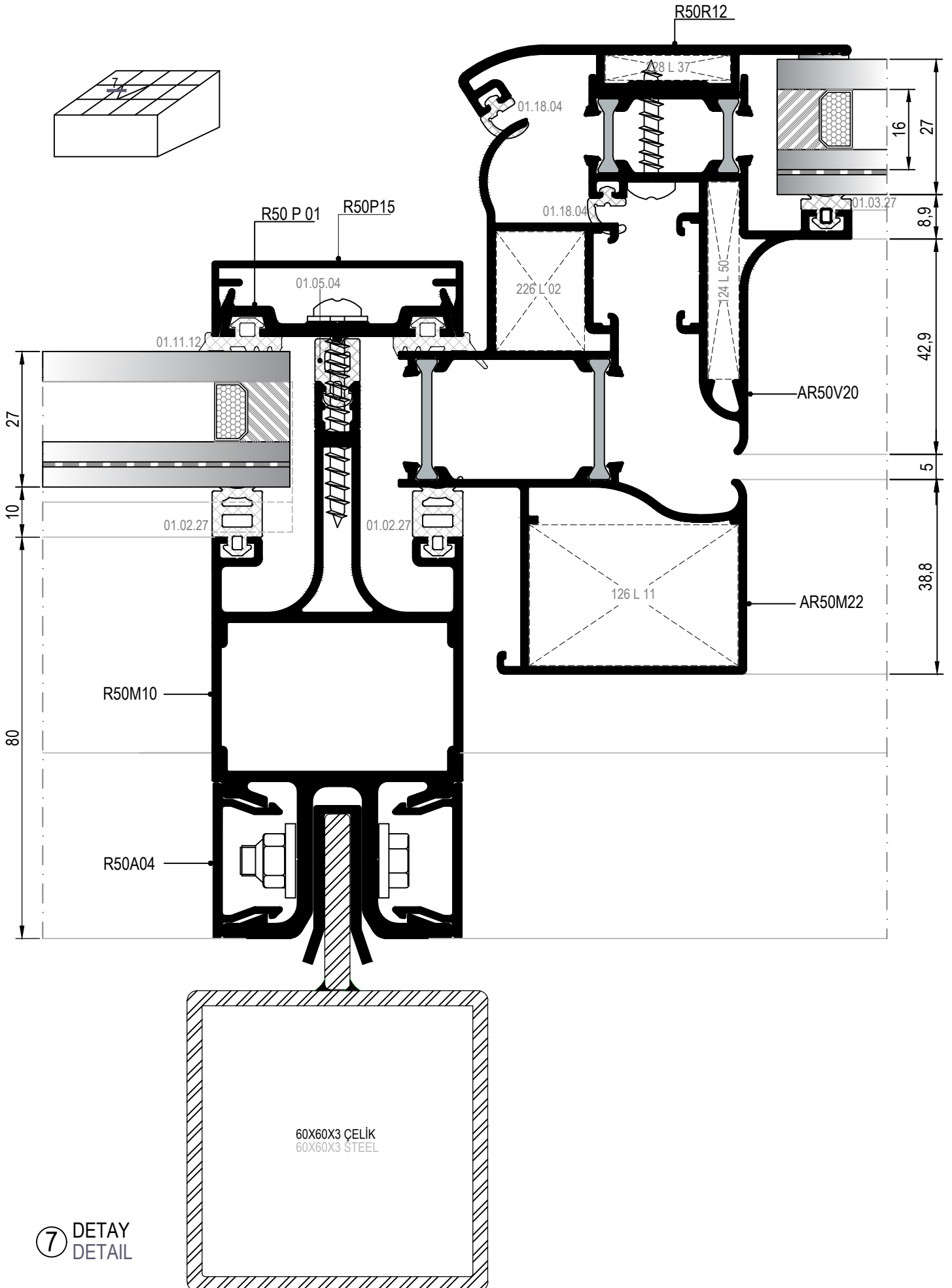

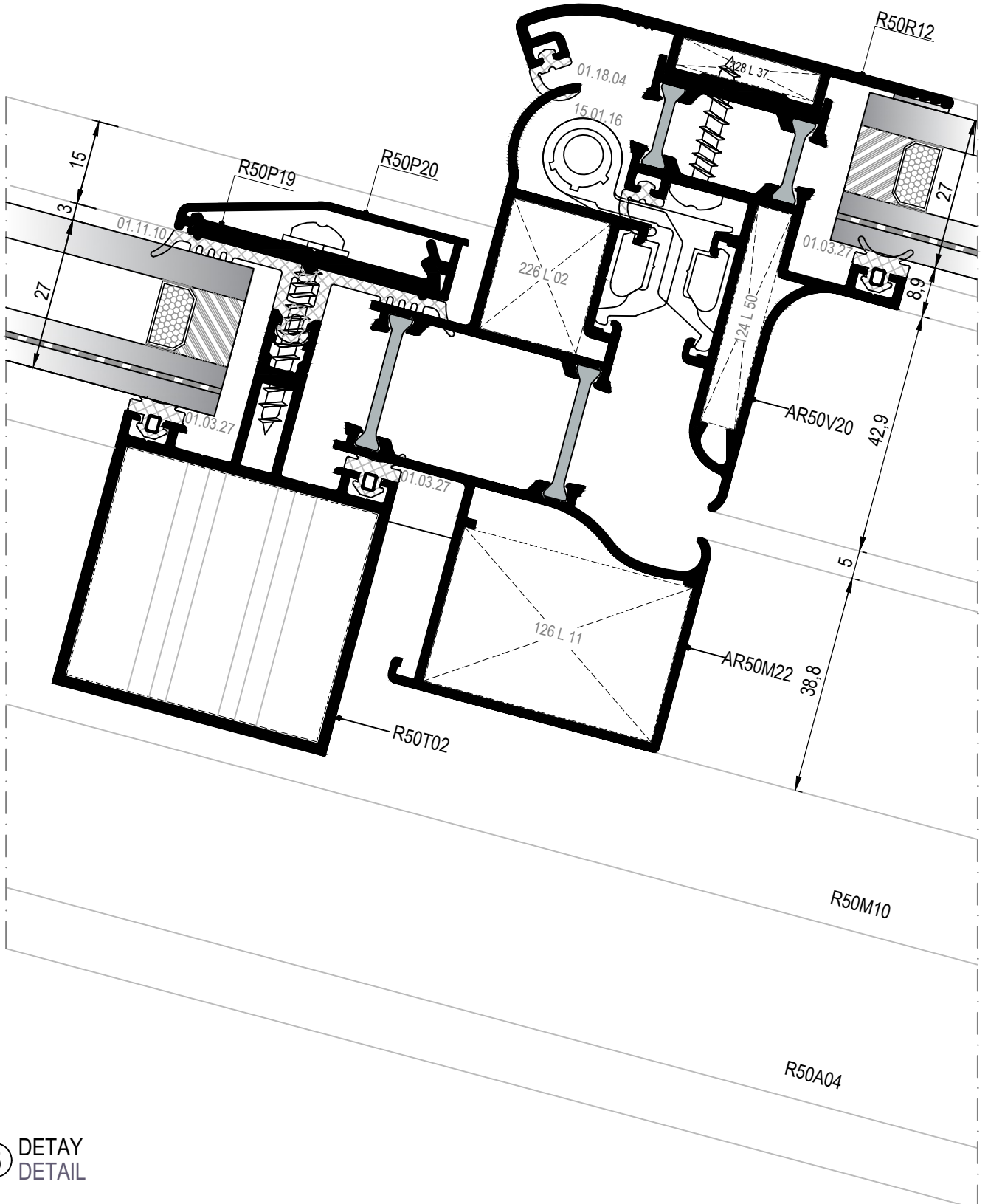
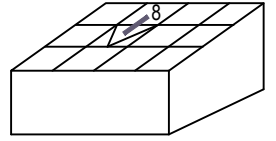

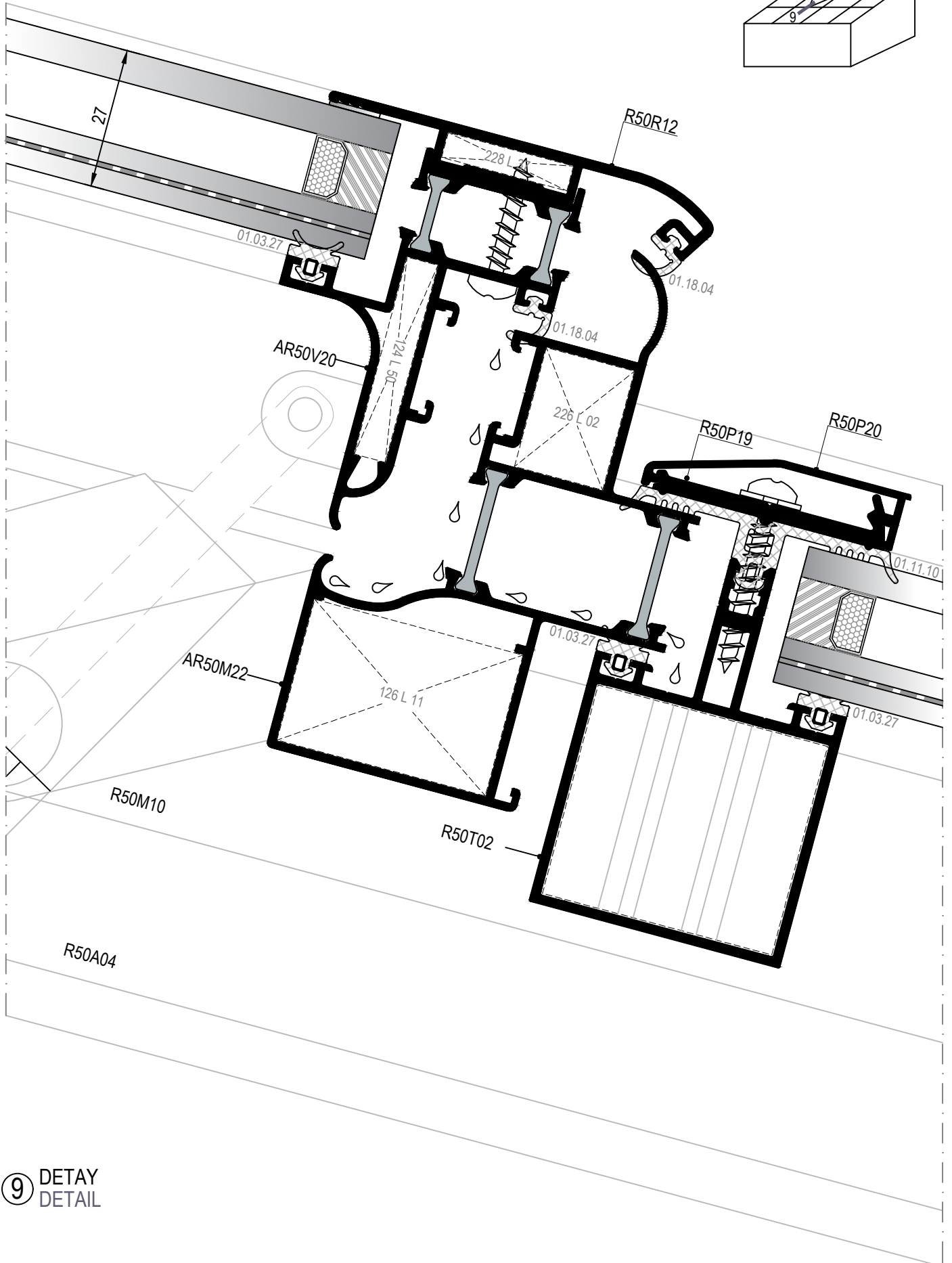
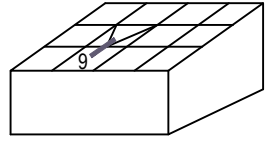

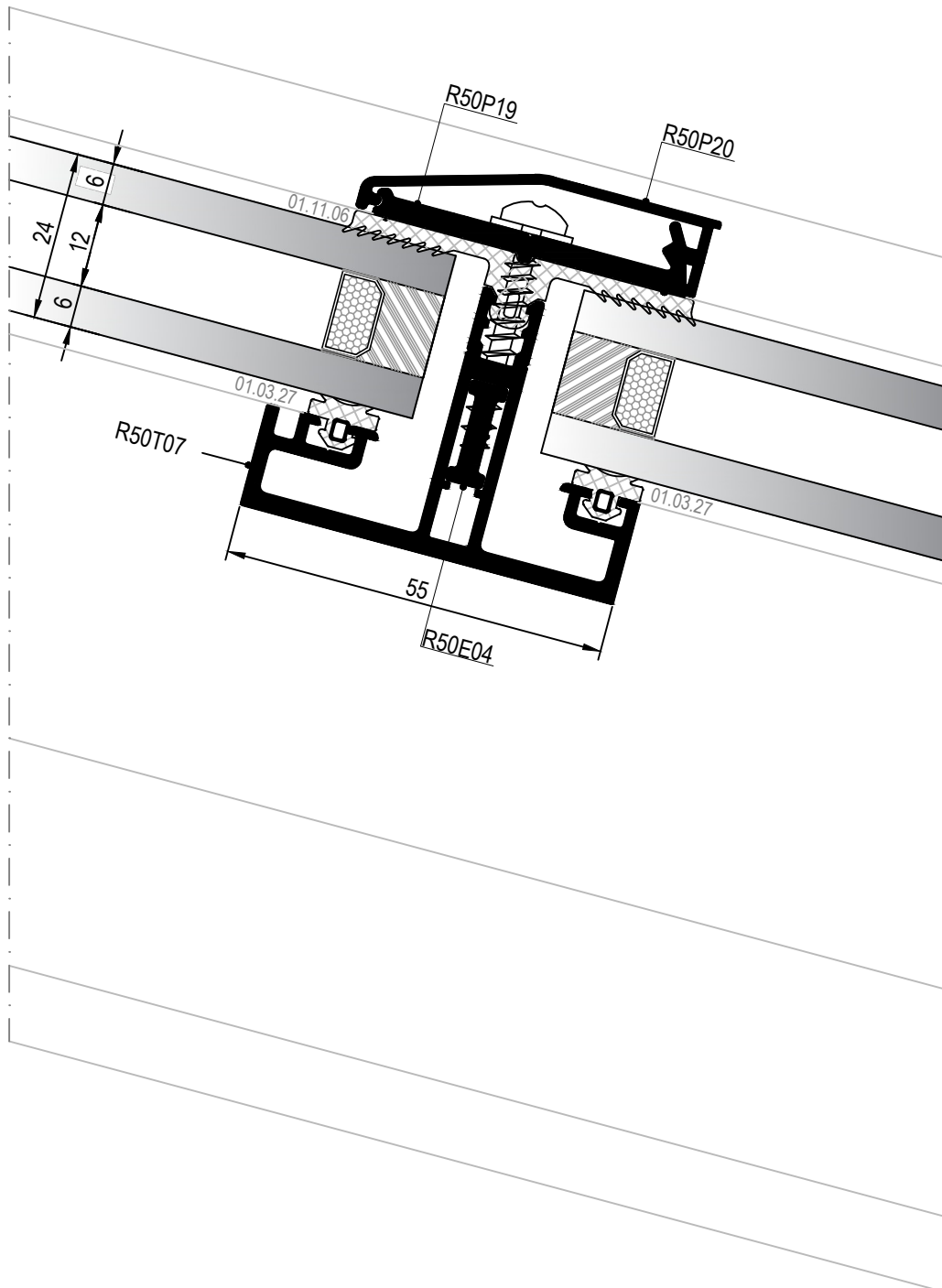
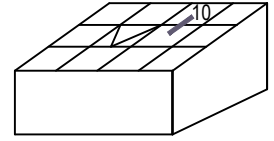







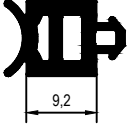
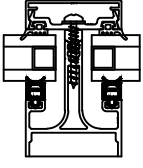
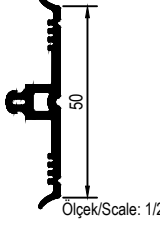
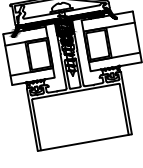

MİMARİ KATALOG
ARCHITECTURAL CATALOGUE

Alüminyum Cephe Sistemleri
Aluminium Facade Systems

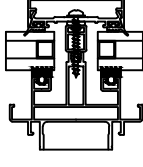
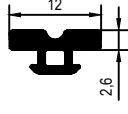
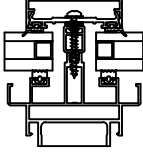
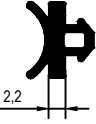
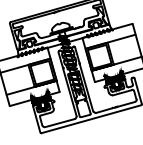
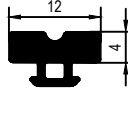
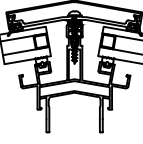
SKY65

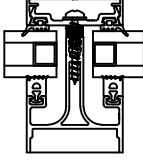
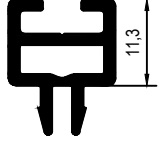
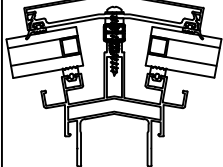
AKSESUARLAR

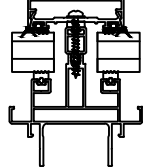
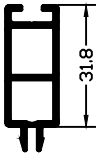
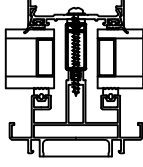
ACCESSORIES

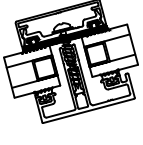
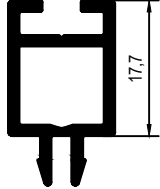
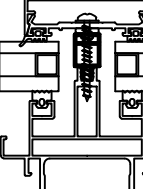
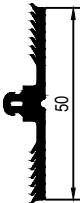
	01.02.27 CAM FİTİLİ GLAZING GASKET Malzeme / Material : EPDM Ağırlık / Weight : 116 gr/m Paket / Package: 127 m / 15 kg			01.11.10 KAPAK ALTI FİTİLİ GLAZING GASKET Malzeme / Material : EPDM Ağırlık / Weight : 240 gr/m Paket / Package: 62,5 m / 15 kg	
	01.02.11 CAM FİTİLİ GLAZING GASKET Malzeme / Material : EPDM Ağırlık / Weight : 87 gr/m Paket / Package: 172 m / 15 kg			01.15.01 ORTA FİTİLİ CENTRAL GASKET Malzeme / Material : EPDM Ağırlık / Weight : 52 gr/m Paket / Package: 288,46 m / 15 kg	
	01.03.27 CAM FİTİLİ GLAZING GASKET Malzeme / Material : EPDM Ağırlık / Weight : 56 gr/m Paket / Package: 242 m / 15 kg			01.15.02 ORTA FİTİLİ CENTRAL GASKET Malzeme / Material : EPDM Ağırlık / Weight : 77 gr/m Paket / Package: 194,8 m / 15 kg	
	01.05.01 ORTA BASKI FİTİLİ CENTRAL GASKET Malzeme / Material : EPDM Ağırlık / Weight : 84 gr/m Paket / Package: 178 m / 15 kg			02.01.11 PVC PROFİL PVC PROFILE Malzeme / Material : PVC	
	01.11.12 DIŞ CAM FİTİLİ GLAZING GASKET (OUT) Malzeme / Material : EPDM Ağırlık / Weight : 90 gr/m Paket / Package: 166 m / 15 kg			02.01.12 PVC PROFİL PVC PROFILE Malzeme / Material : PVC	
	01.11.05 KAPAK ALTI FİTİLİ GLAZING GASKET Malzeme / Material : EPDM Ağırlık / Weight : 235 gr/m Paket / Package: 64 m / 15 kg			04.08.03 PVC PROFİL PVC PROFILE Malzeme / Material : PVC	
	01.11.06 KAPAK ALTI FİTİLİ GLAZING GASKET Malzeme / Material : EPDM Ağırlık / Weight : 228 gr/m Paket / Package: 65,8 m / 15 kg	