

MİMARİ KATALOG
ARCHITECTURAL CATALOGUE

Alüminyum Kapı ve Pencere Sistemleri
Aluminium Door and Window Systems

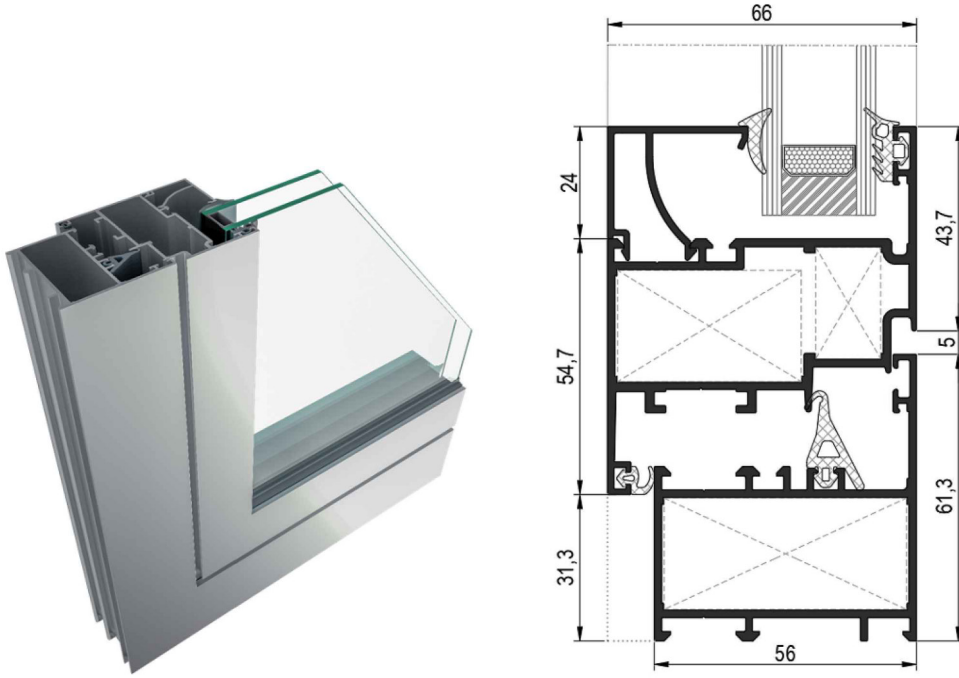

RW56



TEKNİK ÖZELLİKLERİ / TECHNICAL PROPERTIES

	DÜZ HATLI STRAIGHT	OVAL OVAL
KASA DERİNLİĞİ / FRAME DEPTH	56mm	64,8mm
KANAT DERİNLİĞİ / VENT DEPTH	66mm	
PROFİL ET KALINLIĞI / PROFILE WALL THICKNESS	1,6 / 2mm	
MAKS. CAM KALINLIĞI / MAX. GLASS THICKNESS	39mm	

KULLANIM SEÇENEKLERİ / APPLICATION ALTERNATIVES

	KAPI DOOR	PENCERE WINDOW
İÇE AÇILIR / INWARD OPENING	•	•
DIŞA-İÇE AÇILIR HEMYÜZ KAPI / OUTWARD-INWARD OPENING COPLANAR DOOR	•	
VASİSTAS / BOTTOM HUNG		•
ÇİFT EKSEN AÇILIM / TILT&TURN OPENING	•	•

MİMARİ KATALOG
ARCHITECTURAL CATALOGUE

Alüminyum Kapı ve Pencere Sistemleri
Aluminium Door and Window Systems

RW56

PROFİLLER

PROFILES

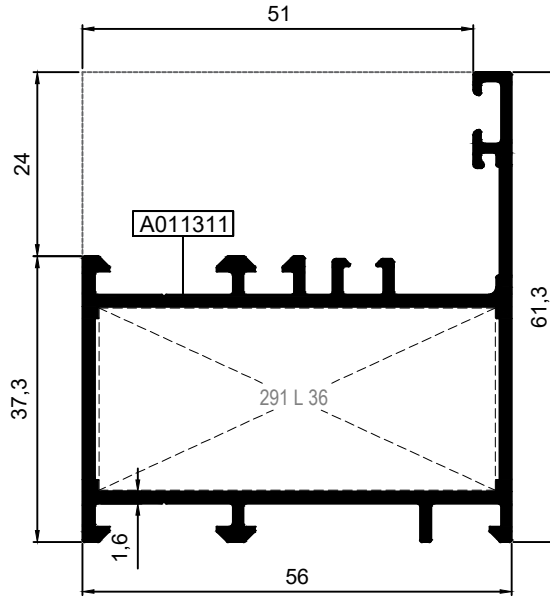

KOD / CODE	AĞIRLIK (kg/m) / WEIGHT	Jxx cm ⁴	Jyy cm ⁴	L m	
M56F02	1,099	17,088	10,554	6	
M56F03	1,281	19,775	12,049	6	

M56F02

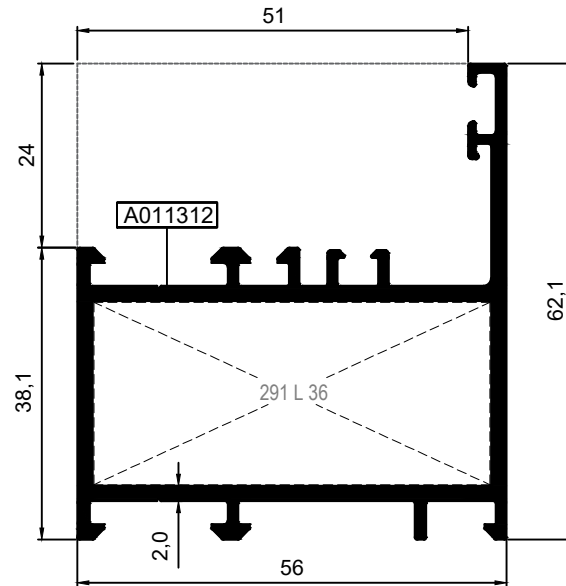

M56F03



Nr		 L m	KESİM ÖLÇÜSÜ CUTTING SIZE	 AKS. KODU ACS. CODE
M56F02	A011311	25L36 (A002397)	51,6 mm	291 L 36
M56F03	A011312	25L36 (A002397)	51,6 mm	291 L 36

KOD / CODE	AĞIRLIK (kg/m) / WEIGHT	Jxx cm ⁴	Jyy cm ⁴	L m	
M56DF01	1,058	17,758	12,647	6	
M56DF02	1,058	17,834	12,717	6	

M56DF01*

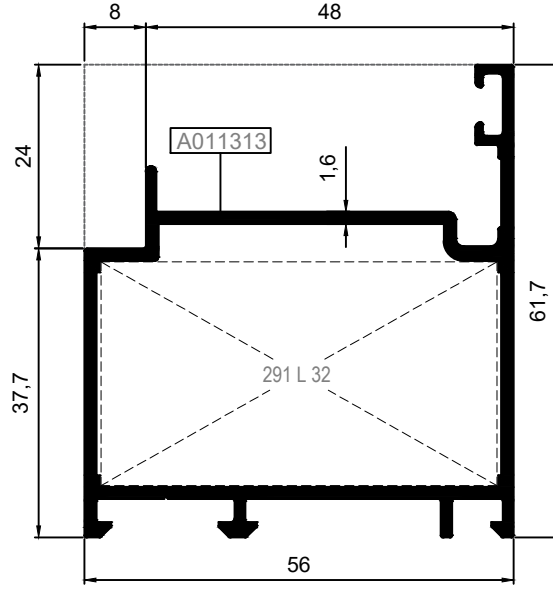

M56DF02**

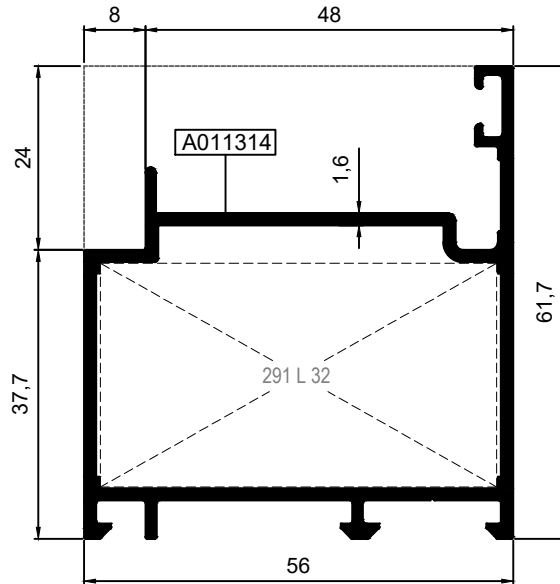



*İÇE AÇILIM HEMYÜZ KAPI KASA PROFİLİ
INWARD OPENING FLUSH DOOR FRAME PROFILE

** DIŞA AÇILIM HEMYÜZ KAPI KASA PROFİLİ
OUTWARD OPENING FLUSH DOOR FRAME PROFILE

Nr		L m	KESİM ÖLÇÜSÜ CUTTING SIZE	AKS. KODU ACS. CODE
M56DF01	A011313	25L32 (A002430)	51,6 mm	291 L 32
M56DF02	A011314	25L32 (A002430)	51,6 mm	291 L 32

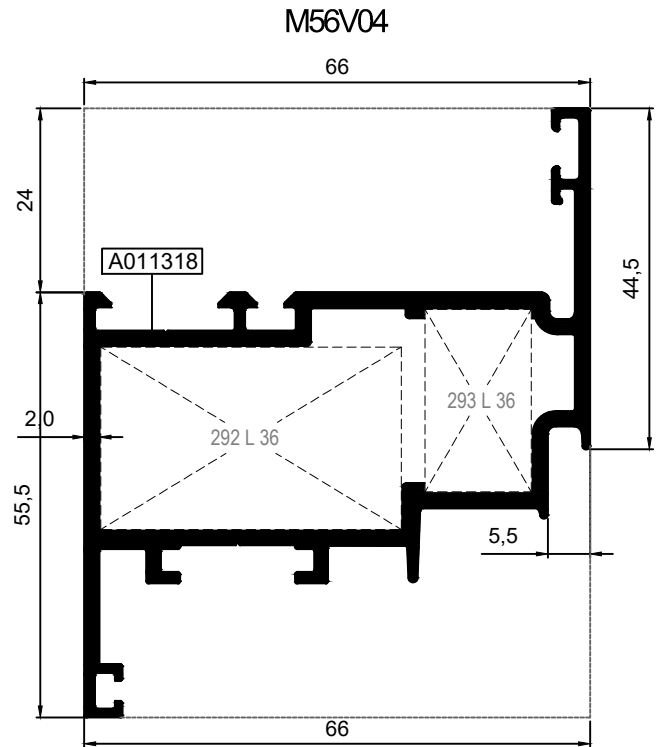
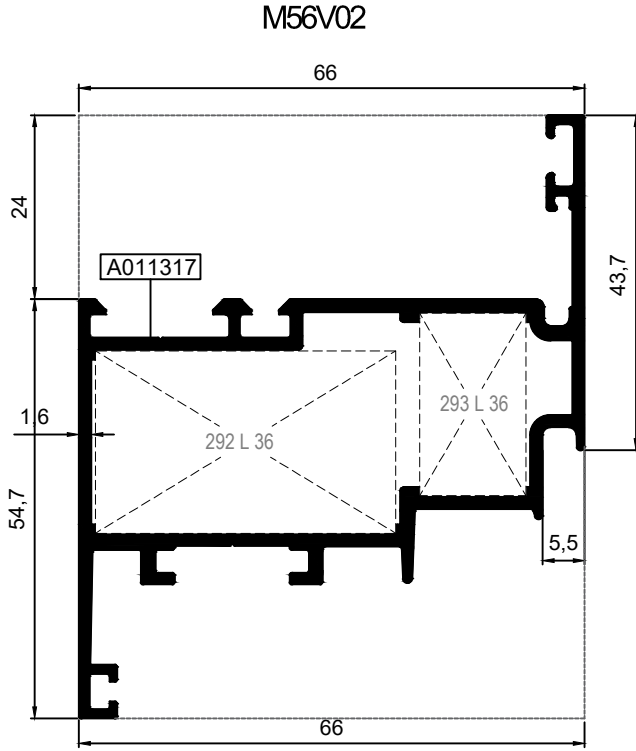
KOD / CODE	AĞIRLIK (kg/m) / WEIGHT	Jxx cm4	Jyy cm4	L m	
M56V02	1,315	28,389	15,253	6	
M56V04	1,535	32,624	17,355	6	



Nr		 L m	KESİM ÖLÇÜSÜ CUTTING SIZE	 AKS. KODU ACS. CODE
M56V02	A011317	25L36 (A002397)	39,1 mm	292 L 36
		25L36 (A002397)	13,8 mm	293 L 36
M56V04	A011318	25L36 (A002397)	39,1 mm	292 L 36
		25L36 (A002397)	13,8 mm	293 L 36

KOD / CODE	AĞIRLIK (kg/m) / WEIGHT	Jxx cm ⁴	Jyy cm ⁴	L m	
M56DV01	1,301	23,652	28,906	6	
M56DV03	1,517	27,255	32,967	6	

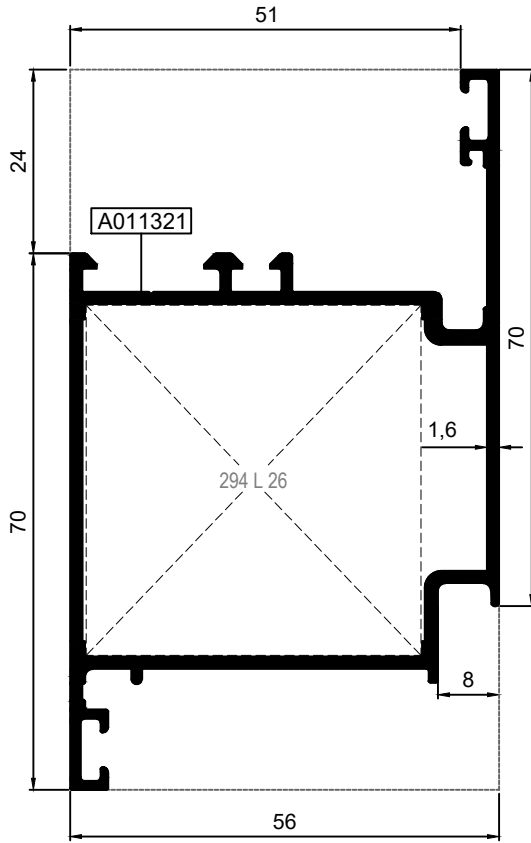

İÇE AÇILIM HEMYÜZ KAPI KANAT PROFİLLERİ
INWARD OPENING FLUSH DOOR VENT PROFILES

M56DV01

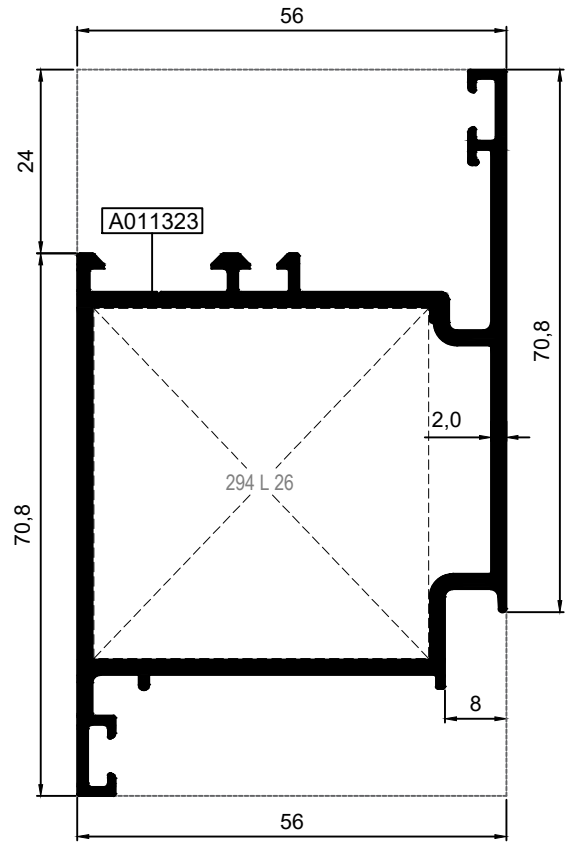

M56DV03

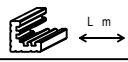

Nr			KEŞİM ÖLÇÜSÜ CUTTING SIZE	 AKS. KODU ACS. CODE
M56DV01	A011321	25L26 (A010540)	43,6 mm	294 L 26
M56DV03	A011323	25L26 (A010540)	43,6 mm	294 L 26

KOD / CODE	AĞIRLIK (kg/m) / WEIGHT	Jxx cm ⁴	Jyy cm ⁴	L m	
M56DV02	1,307	22,526	28,943	6	
M56DV04	1,523	26,132	32,976	6	

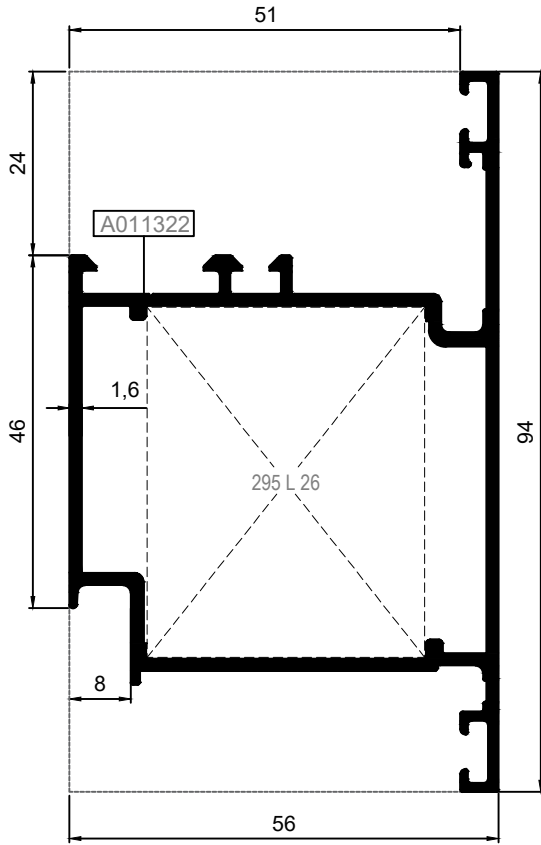

DIŞA AÇILIM HEMÜZ KAPI KANAT PROFİLLERİ
OUTWARD OPENING FLUSH DOOR VENT PROFILES

M56DV02

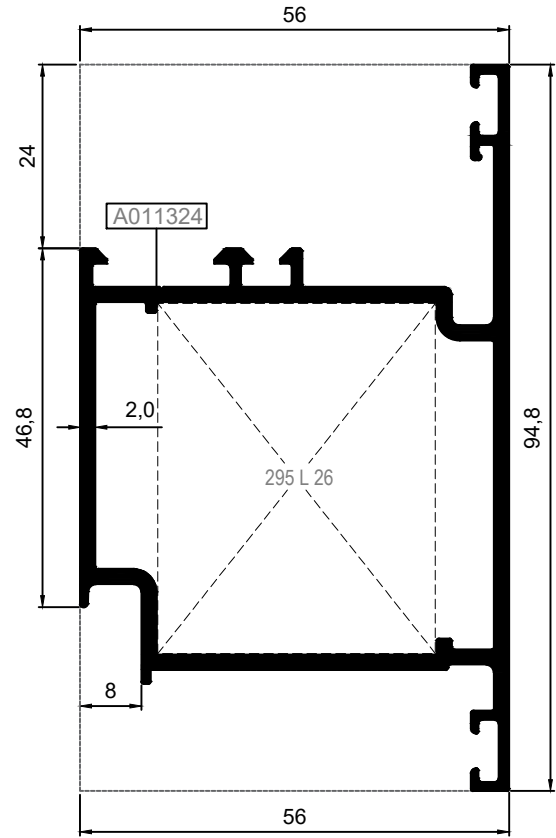

M56DV04

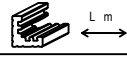

Nr		 L m	KESİM ÖLÇÜSÜ CUTTING SIZE	 AKS. KODU ACS. CODE
M56DV02	A011322	25L26 (A010540)	36,1 mm	295 L 26
M56DV04	A011324	25L26 (A010540)	36,1 mm	295 L 26

KOD / CODE	AĞIRLIK (kg/m) / WEIGHT	Jxx cm ⁴	Jyy cm ⁴	L m	
M56M02	1,285	19,612	17,413	6	
M56M06	1,479	22,525	19,346	6	

M56M02

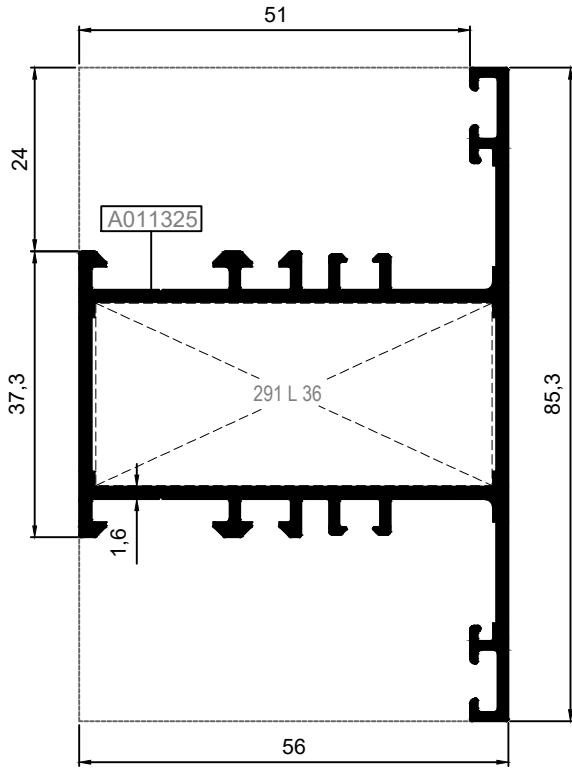

M56M06

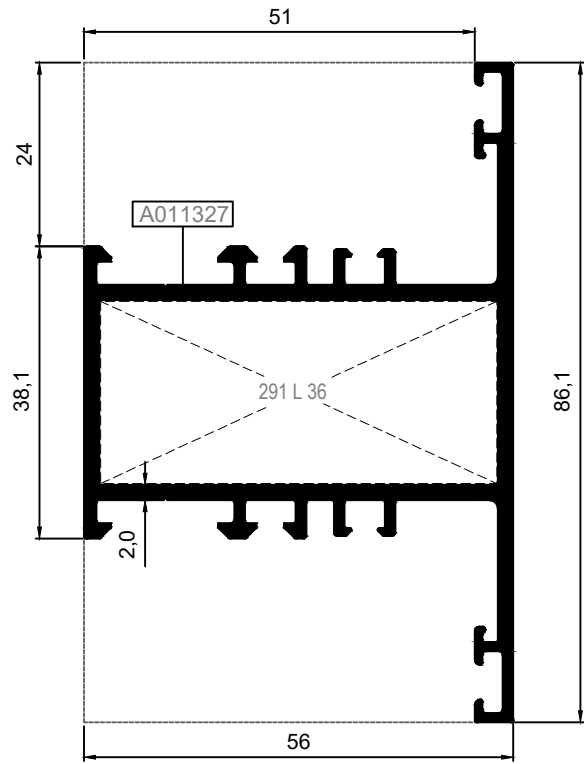

Nr		L m	KEŞİM ÖLÇÜSÜ CUTTING SIZE	AKS. KODU ACS. CODE
M56M02	A011325	25L36 (A002397)	51,6 mm	291 L 36
M56M06	A011327	25L36 (A002397)	51,6 mm	291 L 36
Nr		L m	KEŞİM ÖLÇÜSÜ CUTTING SIZE	AKS. KODU ACS. CODE
M56M02	A011325	25J25 (A011337)	23,7 mm	285 J 25
M56M06	A011327	25J25 (A011337)	23,7 mm	285 J 25

KOD / CODE	AĞIRLIK (kg/m) / WEIGHT	Jxx cm ⁴	Jyy cm ⁴	L m	
M56M05	1,296	29,164	17,206	6	
M56M07	1,511	33,556	19,256	6	

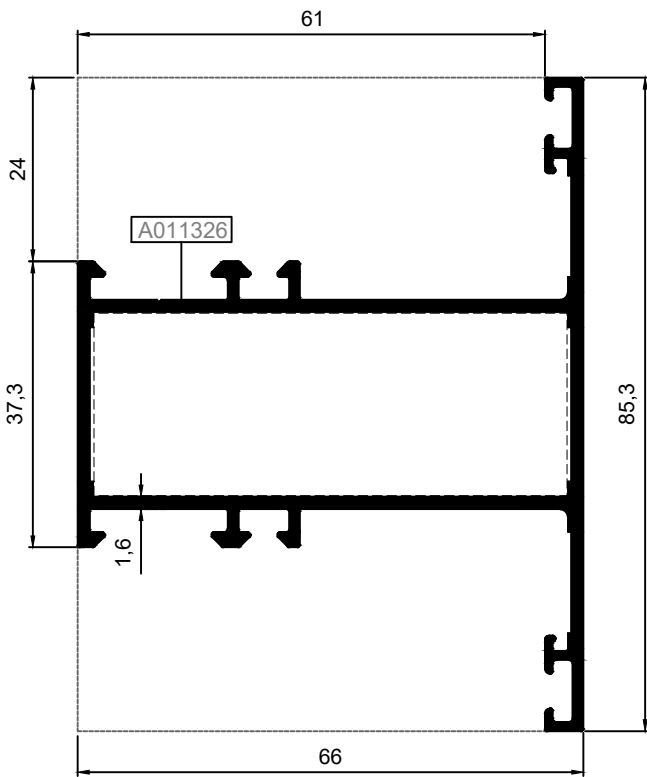

M56M05*

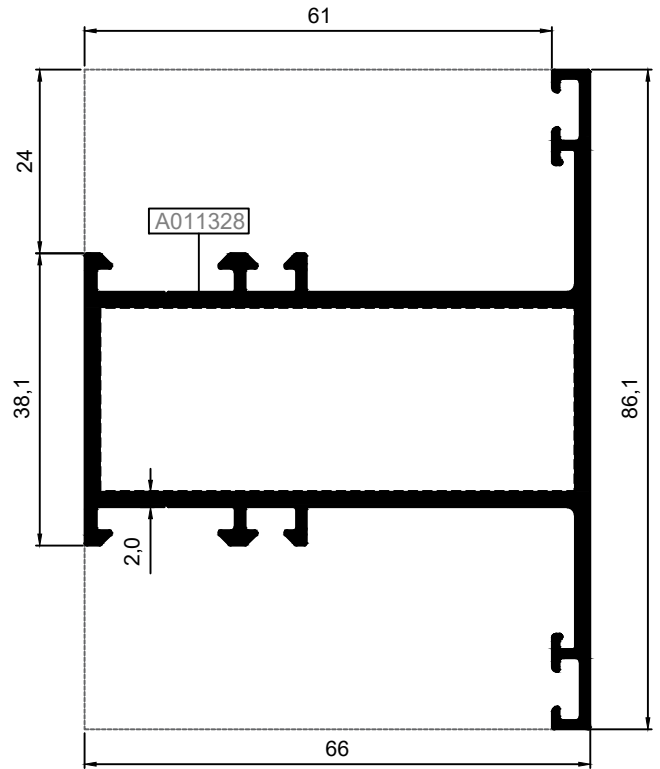

M56M07*

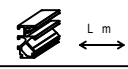

*M56V02 & M56V04 KANAT PROFİLLERİ İLE KULLANILIR
USE WITH M56V02& M56V04 VENT PROFILES

Nr			KEŞİM ÖLÇÜSÜ CUTTING SIZE	 AKS. KODU ACS. CODE
M56M05	A011326	25J24 (A011336)	23,7 mm	285 J 24
M56M07	A011328	25J24 (A011336)	23,7 mm	285 J 24

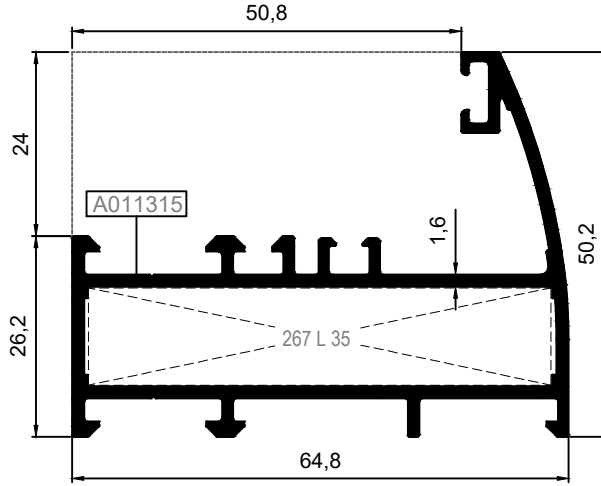

KOD / CODE	AĞIRLIK (kg/m) / WEIGHT	Jxx cm ⁴	Jyy cm ⁴	L m	
M56CF01	1,117	19,723	6,652	6	
M56CF02	1,214	23,295	12,594	6	

M56CF01

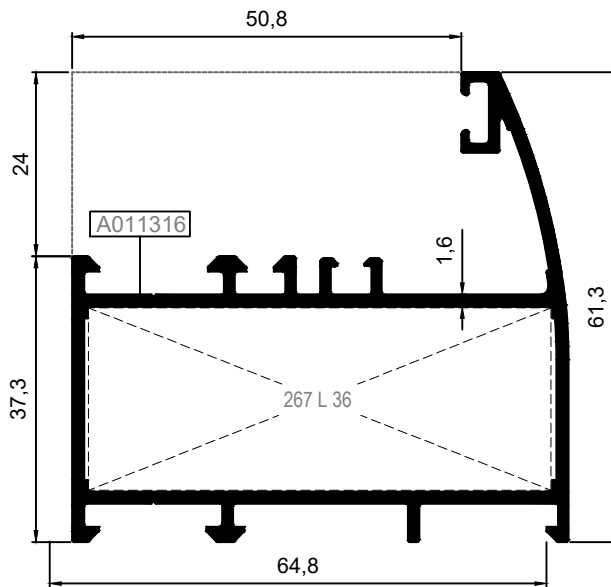

M56CF02



Nr		 L m	KESİM ÖLÇÜSÜ CUTTING SIZE	 AKS. KODU ACS. CODE
M56CF01	A011315	25L35 (A010076)	60,3 mm	267 L 35
M56CF02	A011316	25L36 (A002397)	60,3 mm	267 L 36

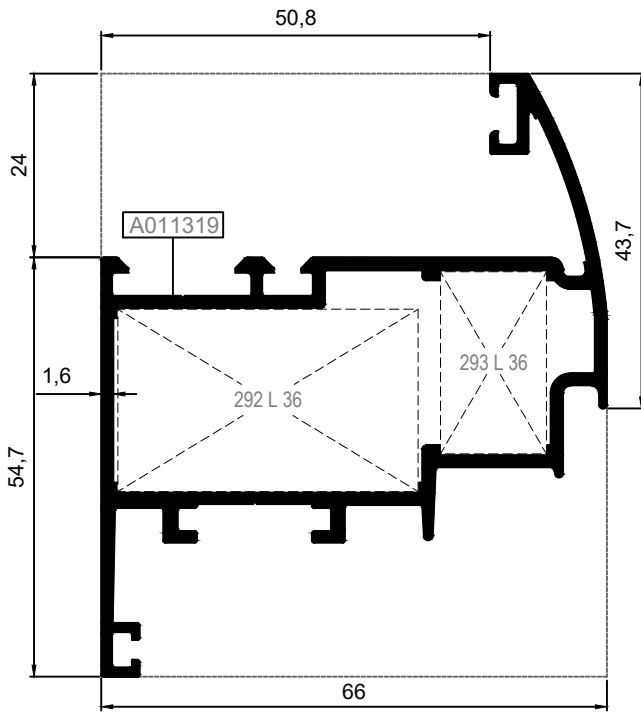

KOD / CODE	AĞIRLIK (kg/m) / WEIGHT	Jxx cm ⁴	Jyy cm ⁴	L m	
M56CV02	1,337	26,961	16,930	6	
M56CV03	1,527	34,233	40,541	6	

M56CV02

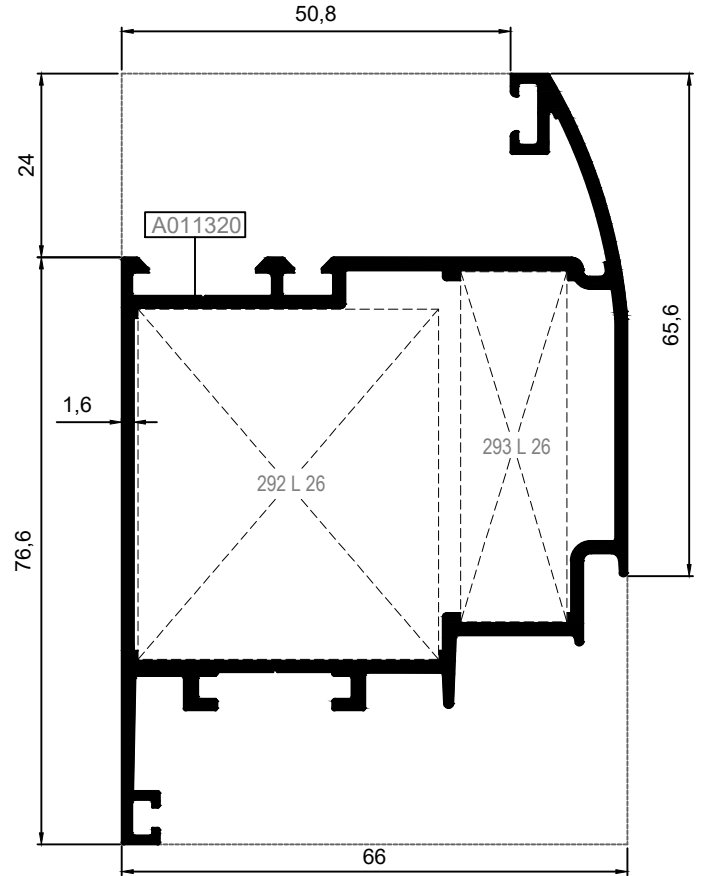

M56CV03



Nr		 L m	KESİM ÖLÇÜSÜ CUTTING SIZE	 AKS. KODU ACS. CODE
M56CV02	A011319	25L36 (A002397)	39,1 mm	292 L 36
		25L36 (A002397)	13,8 mm	293 L 36
M56CV03	A011320	25L26 (A010540)	39,1 mm	292 L 26
		25L26 (A010540)	13,8 mm	293 L 26

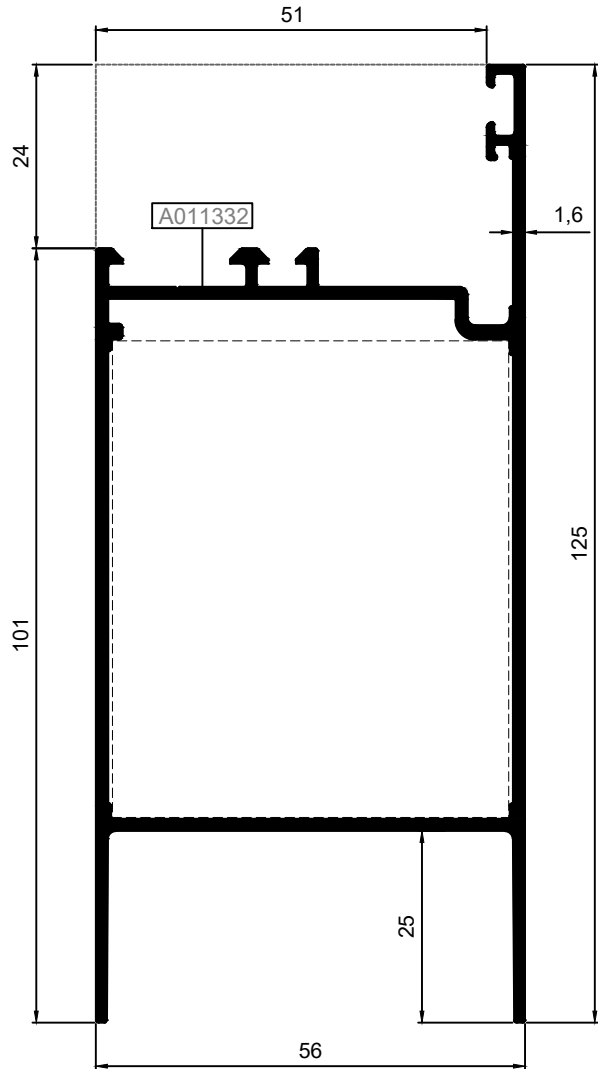

KOD / CODE	AĞIRLIK (kg/m) / WEIGHT	Jxx cm ⁴	Jyy cm ⁴	L m	
M56K01	1,572	32,028	69,692	6	
M56K04	1,900	38,360	83,523	6	

M56K01

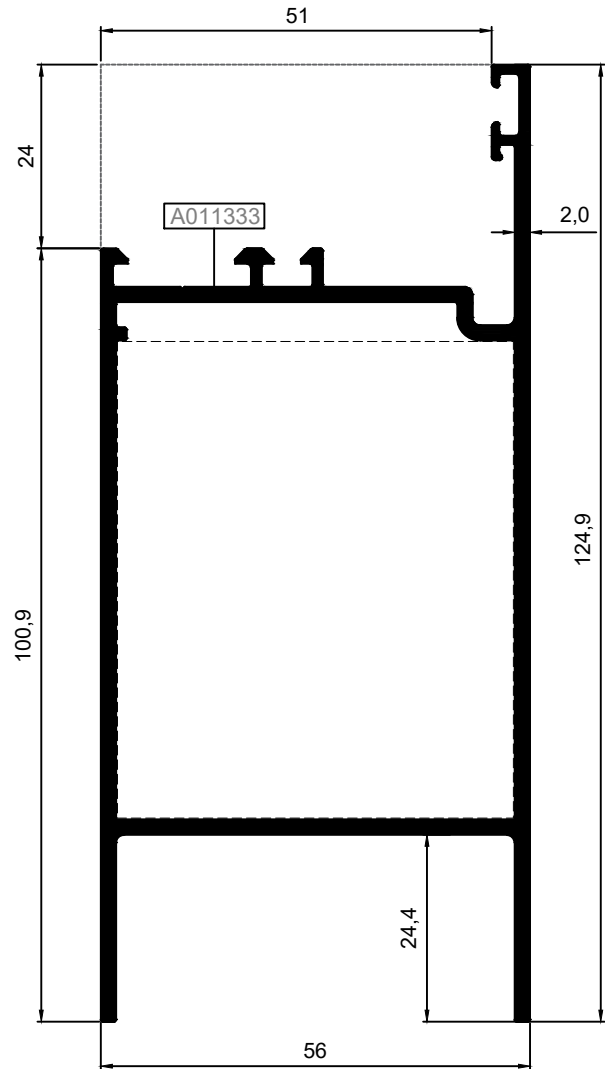

M56K04



Nr		 L m	KESİM ÖLÇÜSÜ CUTTING SIZE	 AKS. KODU ACS. CODE
M56K01	A011332	25J25 (A011337)	62,1 mm	297 J 25
M56K04	A011333	25J25 (A011337)	62,1 mm	297 J 25

KOD / CODE	AĞIRLIK (kg/m) / WEIGHT	Jxx cm4	Jyy cm4	L m	
M56A04	1,144	16,289	8,532	6	
25106	0,105	----	----	6	

M56A04

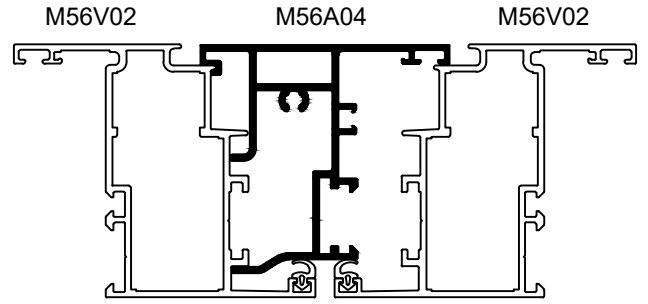
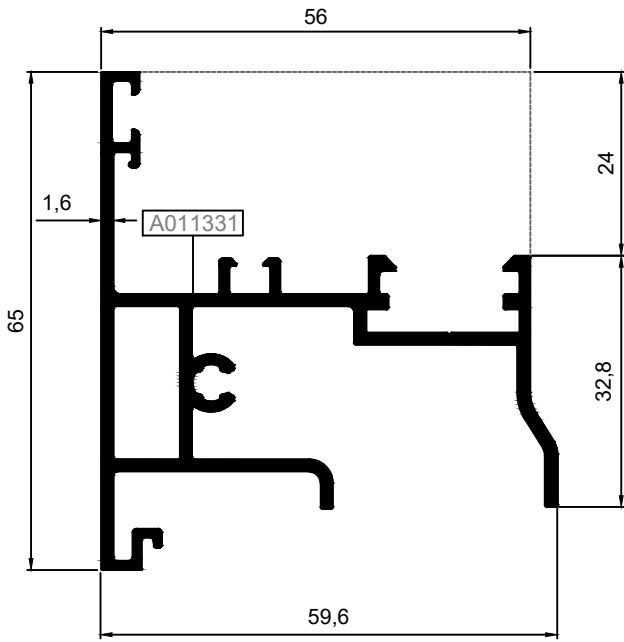

Ölçek/Scale:1/2

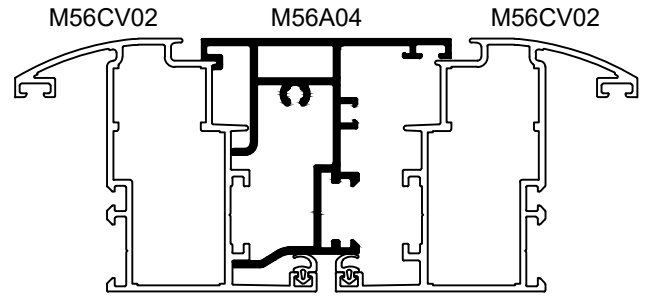

Ölçek/Scale:1/2

25106

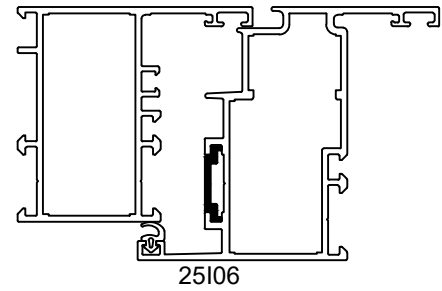
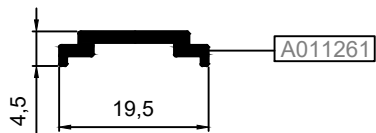

Ölçek/Scale:1/2

KOD / CODE	AĞIRLIK (kg/m) / WEIGHT	Jxx cm ⁴	Jyy cm ⁴	L m	
M56DA01	0,840	10,344	4,429	6	
M56DA02	0,845	10,232	4,431	6	
MT65A01	0,273	----	----	6	

M56DA01

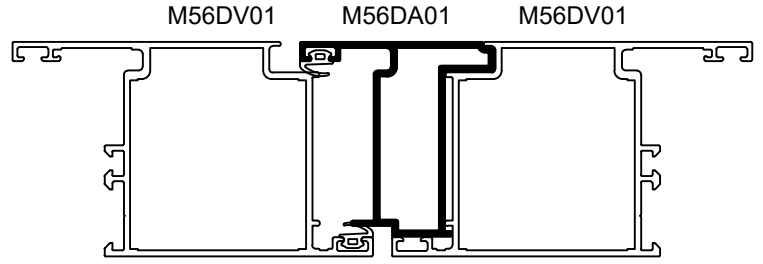
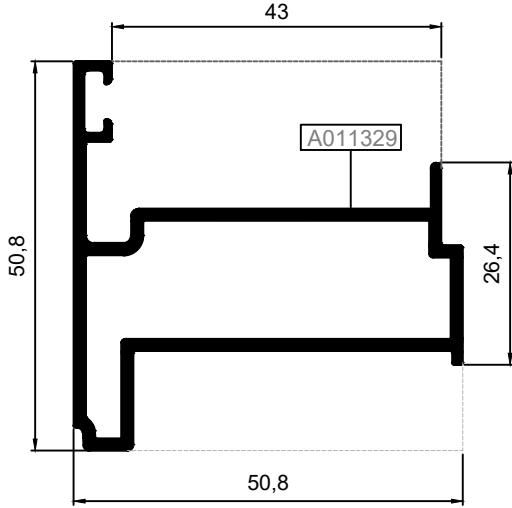

İÇE AÇILIM HEMYÜZ KAPI
INWARD OPENING FLUSH DOOR

Ölçek/Scale:1/2

M56DA02

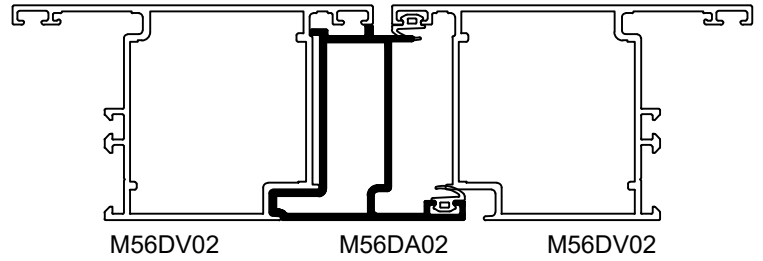
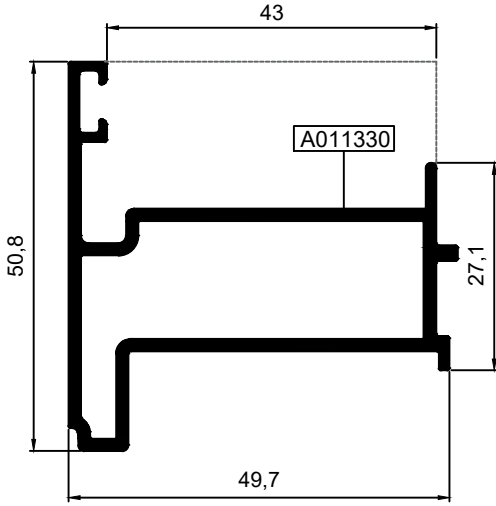

DIŞA AÇILIM HEMYÜZ KAPI
OUTWARD OPENING FLUSH DOOR

Ölçek/Scale:1/2

MT65A01

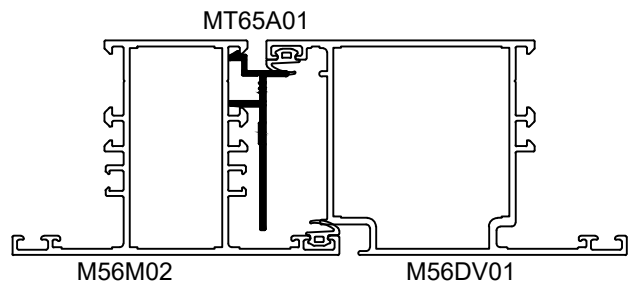
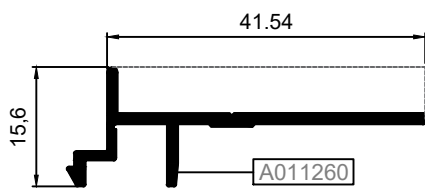

İÇE AÇILIM HEMYÜZ KAPI
INWARD OPENING FLUSH DOOR

Ölçek/Scale:1/2

KOD / CODE	AĞIRLIK (kg/m) / WEIGHT	Jxx cm ⁴	Jyy cm ⁴	L m	
M56C01	1,147	25,241	25,241	6	
M56C02	0,897	12,092	9,039	6	
MT65A02	0,090	----	----	6	

M56C01

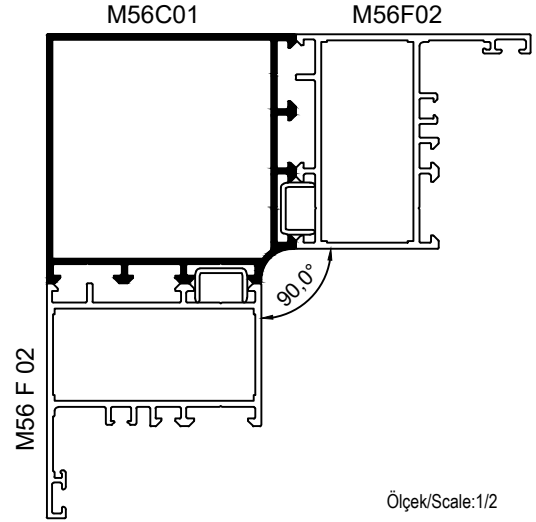
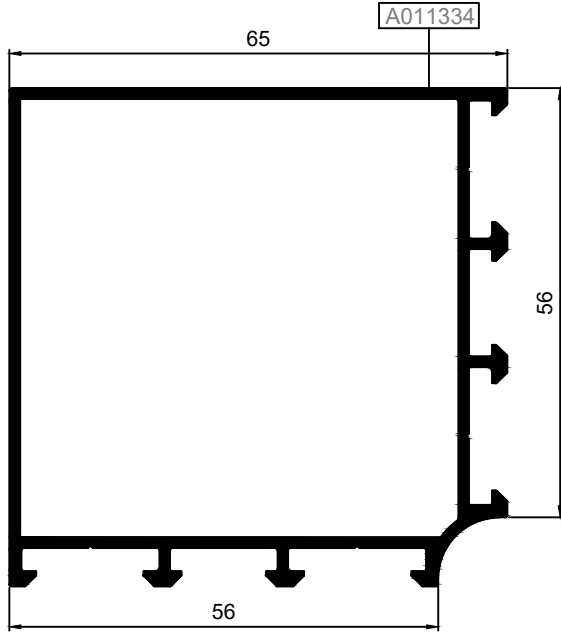

M56C02

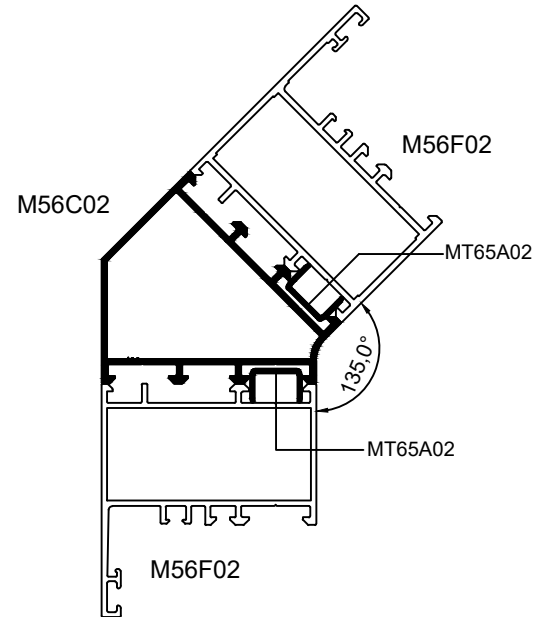
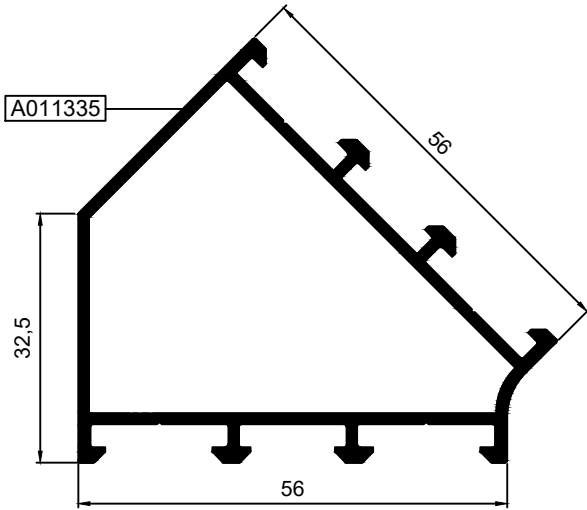

MT65A02

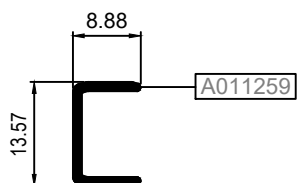

KOD / CODE	AĞIRLIK (kg/m) / WEIGHT	Jxx cm4	Jyy cm4	L m	
24G13	0,296	----	----	6	
24G14	0,315	----	----	6	
24G15	0,334	----	----	6	
24G16	0,353	----	----	6	

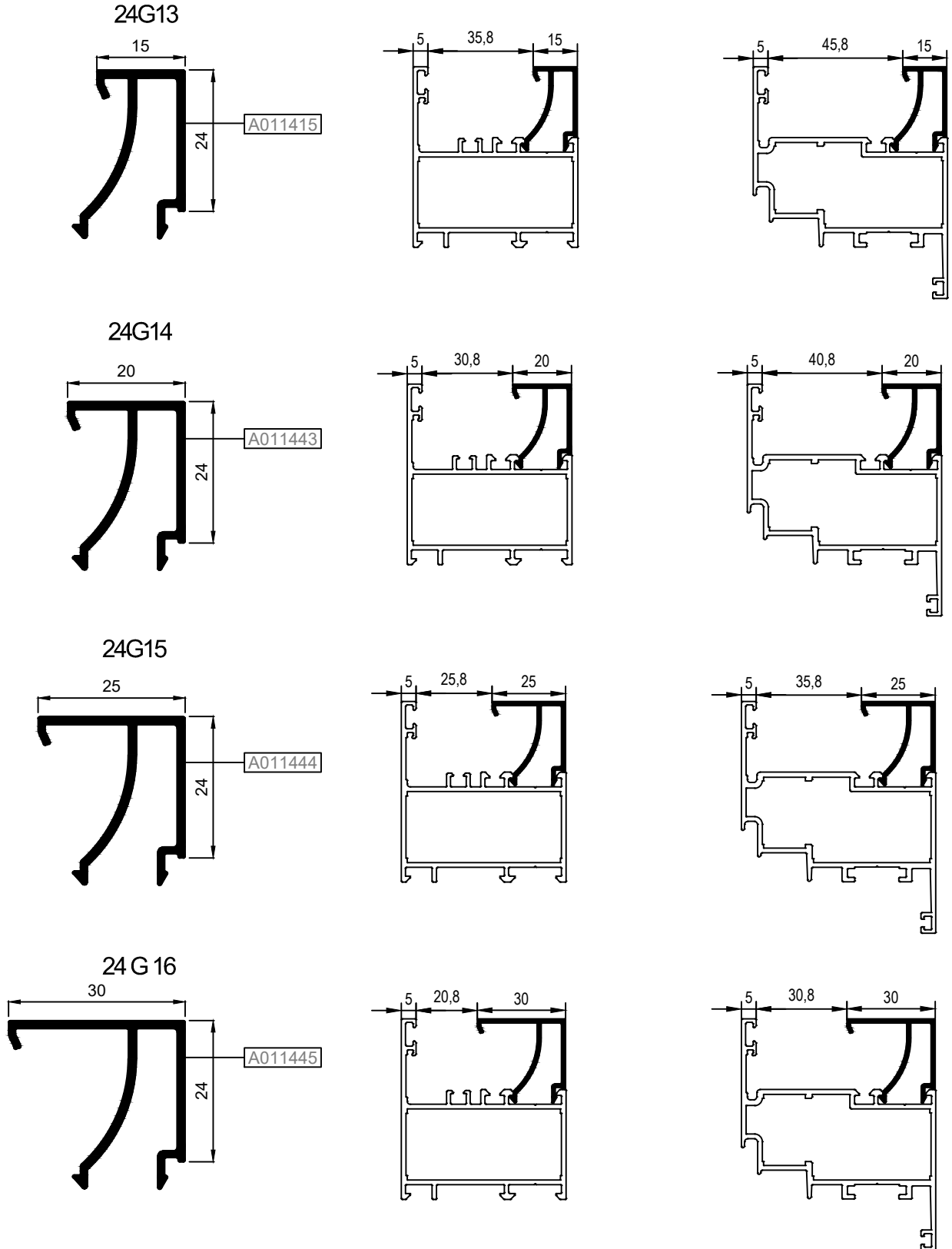

KOD / CODE	AĞIRLIK (kg/m) / WEIGHT	Jxx cm ⁴	Jyy cm ⁴	L m
24G17	0,372	----	----	6
24G18	0,391	----	----	6

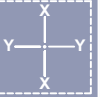

24 G 17

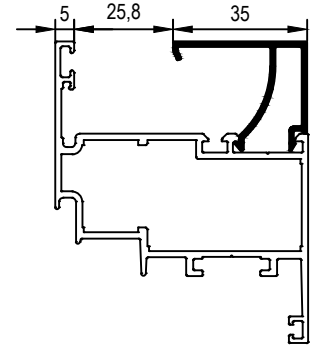
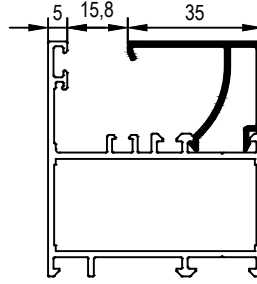
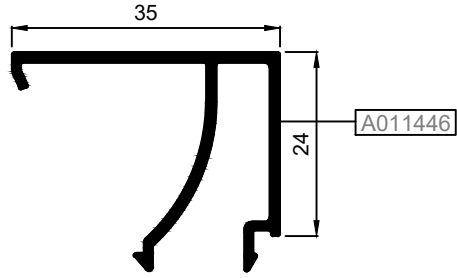

24 G 18

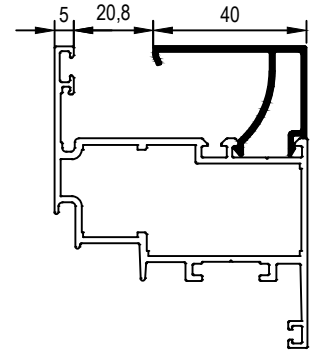
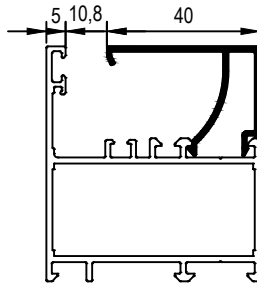
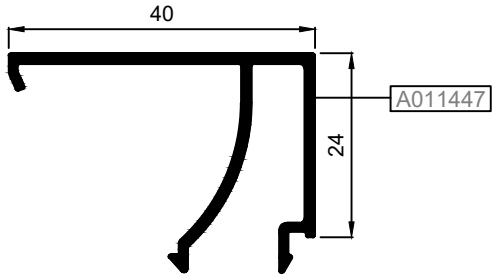

UYGULANAN PROFİLLER: M56F02-M56F03-M56DV01-M56DV02-M56DV03-M56DV04-M56CF01-M56CF02-M56CV02-M56CV03-M56M02
M56M06-M56K01-M56K04
USE WITH: M56F02-M56F03-M56DV01-M56DV02-M56DV03-M56DV04-MT56CF01-M56CF02-M56CV02-M56CV03-M56M02-M56M06-M56K01-M56K04

B CAM ÇİTASI GLAZING BEAD	C İÇ CAM FİTİLİ GLAZING GASKET	A CAM KALINLIĞI GLASS THICKNESS	D DIŞ CAM FİTİLİ GLAZING GASKET
24G13	01.17.20	29 mm	01.11.15
24G13	01.17.05	28 mm	01.11.15
24G13	01.17.14	27 mm	01.11.15
24G13	01.17.15	26 mm	01.11.15
24G13	01.17.21	25 mm	01.11.15
24G14	01.17.20	24 mm	01.11.15
24G14	01.17.05	23 mm	01.11.15
24G14	01.17.14	22 mm	01.11.15
24G14	01.17.15	21 mm	01.11.15
24G14	01.17.21	20 mm	01.11.15
24G15	01.17.20	19 mm	01.11.15
24G15	01.17.05	18 mm	01.11.15
24G15	01.17.14	17 mm	01.11.15
24G15	01.17.15	16 mm	01.11.15
24G15	01.17.21	15 mm	01.11.15
24G16	01.17.20	14 mm	01.11.15
24G16	01.17.05	13 mm	01.11.15
24G16	01.17.14	12 mm	01.11.15
24G16	01.17.15	11 mm	01.11.15
24G16	01.17.21	10 mm	01.11.15

B CAM ÇİTASI GLAZING BEAD	C İÇ CAM FİTİLİ GLAZING GASKET	A CAM KALINLIĞI GLASS THICKNESS	D DIŞ CAM FİTİLİ GLAZING GASKET
24G17	01.17.20	9 mm	01.11.15
24G17	01.17.05	8 mm	01.11.15
24G17	01.17.14	7 mm	01.11.15
24G17	01.17.15	6 mm	01.11.15
24G17	01.17.21	5 mm	01.11.15
24G18	01.17.20	4 mm	01.11.15

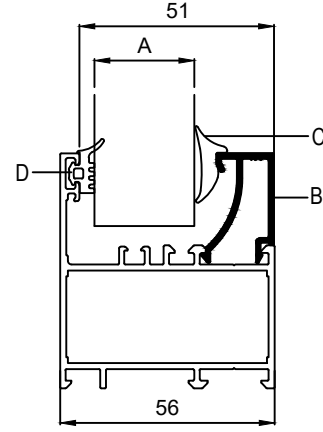

CAM MONTAJINDA SADECE BU SİSTEM İÇİN TASARLANAN VE ÜRETİLEN FİTİLLER KULLANILMALIDIR. FARKLI MALZEME KULLANIMLARI İŞLEVSEL VE TASARIMSAL SORUNLARA SEBEP OLABİLİR. THE GASKETS USED DURING INSTALLING THE GLASS SHOULD BE ONLY THE ONES CREATED FOR THIS SYSTEM. THE USE OF OTHER MATERIALS MAY CAUSE FUNCTIONAL AND DESIGN PROBLEMS.

TABLODA VERİLEN CAM KALINLIKLARI TEORİK OLUP SİSTEMİN ISI PERFORMANS KRİTERLERİNDEN BAĞIMSIZDIR. THE GLASS THICKNESSES IN THE TABLE ARE THEORETICAL AND INDEPENDENT FROM THERMAL PERFORMANCE CRITERIA OF THE SYSTEM.

YUKARIDAKİ TABLODA VERİLEN CAM-FİTİL VE PROFİL İLİŞKİSİ TEORİK OLUP PROFİL VE CAM TOLERANSLARINDAN KAYNAKLI ÖLÇÜ FARKLILIKLARI OLUŞABİLİR. THE RELATIONSHIP BETWEEN GLASS-GASKET AND PROFILE PROVIDED IN THE TABLE IS THEORETICAL. IT MAY OCCUR SIZE DIFFERENCES FROM THE TOLERANCES OF PROFILE AND GLASS.

UYGULANAN PROFİLLER: M56V02-M56V04-M56M05-M56M07
USE WITH: M56V02-M56V04-M56M05-M56M07

B CAM ÇİTASI GLAZING BEAD	C İÇ CAM FİTİLİ GLAZING GASKET	A CAM KALINLIĞI GLASS THICKNESS	D DIŞ CAM FİTİLİ GLAZING GASKET
24G13	01.17.20	39 mm	01.11.15
24G13	01.17.05	38 mm	01.11.15
24G13	01.17.14	37 mm	01.11.15
24G13	01.17.15	36 mm	01.11.15
24 G 13	01.17.21	35 mm	01.11.15
24G14	01.17.20	34 mm	01.11.15
24G14	01.17.05	33 mm	01.11.15
24G14	01.17.14	32 mm	01.11.15
24G14	01.17.15	31 mm	01.11.15
24G14	01.17.21	30 mm	01.11.15
24G15	01.17.20	29 mm	01.11.15
24G15	01.17.05	28 mm	01.11.15
24G15	01.17.14	27 mm	01.11.15
24G15	01.17.15	26 mm	01.11.15
24G15	01.17.21	25 mm	01.11.15
24G16	01.17.20	24 mm	01.11.15
24G16	01.17.05	23 mm	01.11.15
24G16	01.17.14	22 mm	01.11.15
24G16	01.17.15	21 mm	01.11.15
24G16	01.17.21	20 mm	01.11.15

B CAM ÇİTASI GLAZING BEAD	C İÇ CAM FİTİLİ GLAZING GASKET	A CAM KALINLIĞI GLASS THICKNESS	D DIŞ CAM FİTİLİ GLAZING GASKET
24G17	01.17.20	19 mm	01.11.15
24G17	01.17.05	18 mm	01.11.15
24G17	01.17.14	17 mm	01.11.15
24G17	01.17.15	16 mm	01.11.15
24G17	01.17.21	15 mm	01.11.15
24G18	01.17.20	14 mm	01.11.15
24G18	01.17.05	13 mm	01.11.15
24G18	01.17.14	12 mm	01.11.15
24G18	01.17.15	11 mm	01.11.15
24G18	01.17.21	10 mm	01.11.15

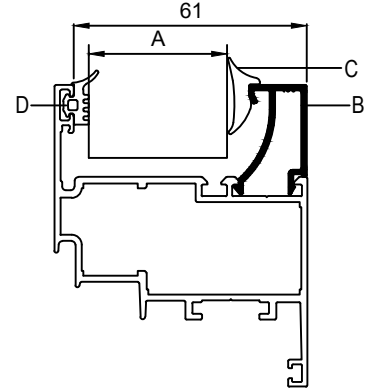

CAM MONTAJINDA SADECE BU SİSTEM İÇİN TASARLANAN VE ÜRETİLEN FİTİLLER KULLANILMALIDIR. FARKLI MALZEME KULLANIMLARI İŞLEVSEL VE TASARIMSAL SORUNLARA SEBEP OLABİLİR. THE GASKETS USED DURING INSTALLING THE GLASS SHOULD BE ONLY THE ONES CREATED FOR THIS SYSTEM. THE USE OF OTHER MATERIALS MAY CAUSE FUNCTIONAL AND DESIGN PROBLEMS.

TABLODA VERİLEN CAM KALINLIKLARI TEORİK OLUP SİSTEMİN ISI PERFORMANS KRİTERLERİNDEN BAĞIMSIZDIR. THE GLASS THICKNESSES IN THE TABLE ARE THEORETICAL AND INDEPENDENT FROM THERMAL PERFORMANCE CRITERIA OF THE SYSTEM.

YUKARIDAKİ TABLODA VERİLEN CAM-FİTİL VE PROFİL İLİŞKİSİ TEORİK OLUP PROFİL VE CAM TOLERANSLARINDAN KAYNAKLI ÖLÇÜ FARKLILIKLARI OLUŞABİLİR. THE RELATIONSHIP BETWEEN GLASS-GASKET AND PROFILE PROVIDED IN THE TABLE IS THEORETICAL. IT MAY OCCUR SIZE DIFFERENCES FROM THE TOLERANCES OF PROFILE AND GLASS.

TAKOZLAR (CLEATS)

PROFİL KODU (PROFILE CODE)	25L26	25L32	25L35	25L36
FABRİKA KODU(FACTORY CODE)	A010540	A002430	A010076	A002397
AĞIRLIK (WEIGHT)	4,870 kg/m	3,702 kg/m	4,192 kg/m	3,229 kg/m
ÇİZİM (DRAWING)				

PROFİL KODU (PROFILE CODE)	25J24	25J25		
FABRİKA KODU(FACTORY CODE)	A011336	A011337		
AĞIRLIK (WEIGHT)	1,318 kg/m	1,232 kg/m		
ÇİZİM (DRAWING)				

KÖŞE TAKOZLARI (CORNER CLEATS)

Nr		L m	KESİM ÖLÇÜSÜ CUTTING SIZE	AKS. KODU ACS. CODE
M56F02	A011311	25L36 (A002397)	51,6 mm	291 L 36
M56F03	A011312	25L36 (A002397)	51,6 mm	291 L 36
M56DF01	A011313	25L32 (A002430)	51,6 mm	291 L 32
M56DF02	A011314	25L32 (A002430)	51,6 mm	291 L 32
M56CF01	A011315	25L35 (A010076)	60,3 mm	267 L 35
M56CF02	A011316	25L36 (A002397)	60,3 mm	267 L 36
M56V02	A011317	25L36 (A002397)	39,1 mm	292 L 36
		25L36 (A002397)	13,8 mm	293 L 36
M56V04	A011318	25L36 (A002397)	39,1 mm	292 L 36
		25L36 (A002397)	13,8 mm	293 L 36
M56DV01	A011321	25L26 (A010540)	43,6 mm	294 L 26
M56DV02	A011322	25L26 (A010540)	36,1 mm	295 L 26
M56DV03	A011323	25L26 (A010540)	43,6 mm	294 L 26
M56DV04	A011324	25L26 (A010540)	36,1 mm	295 L 26
M56CV02	A011319	25L36 (A002397)	39,1 mm	292 L 36
		25L36 (A002397)	13,8 mm	293 L 36
M56CV03	A011320	25L26 (A010540)	39,1 mm	292 L 26
		25L26 (A010540)	13,8 mm	293 L 26
M56M02	A011325	25L36 (A002397)	51,6 mm	291 L 36
M56M06	A011327	25L36 (A002397)	51,6 mm	291 L 36

ORTA KAYIT BAĞLANTILARI (MULLION CONNECTION PIECES)

Nr		L m	KESİM ÖLÇÜSÜ CUTTING SIZE	AKS. KODU ACS. CODE
M56M02	A011325	25J25 (A011337)	23,7 mm	285 J 25
M56M05	A011326	25J24 (A011336)	23,7 mm	285 J 24
M56M06	A011327	25J25 (A011337)	23,7 mm	285 J 25
M56M07	A011328	25J24 (A011336)	23,7 mm	285 J 24
M56K01	A011332	25J25 (A011337)	62,1 mm	297 J 25
M56K04	A011333	25J25 (A011337)	62,1 mm	297 J 25

MİMARİ KATALOG
ARCHITECTURAL CATALOGUE

Alüminyum Kapı ve Pencere Sistemleri
Aluminium Door and Window Systems

RW56

DETAYLAR

DETAILS

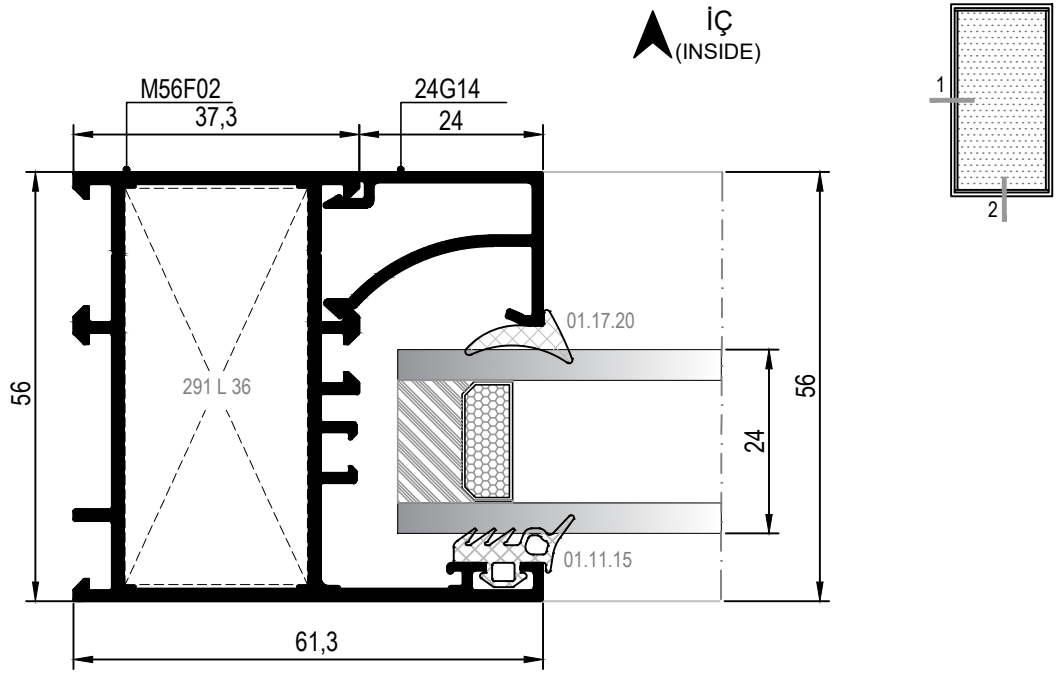

① DETAYI
DETAIL

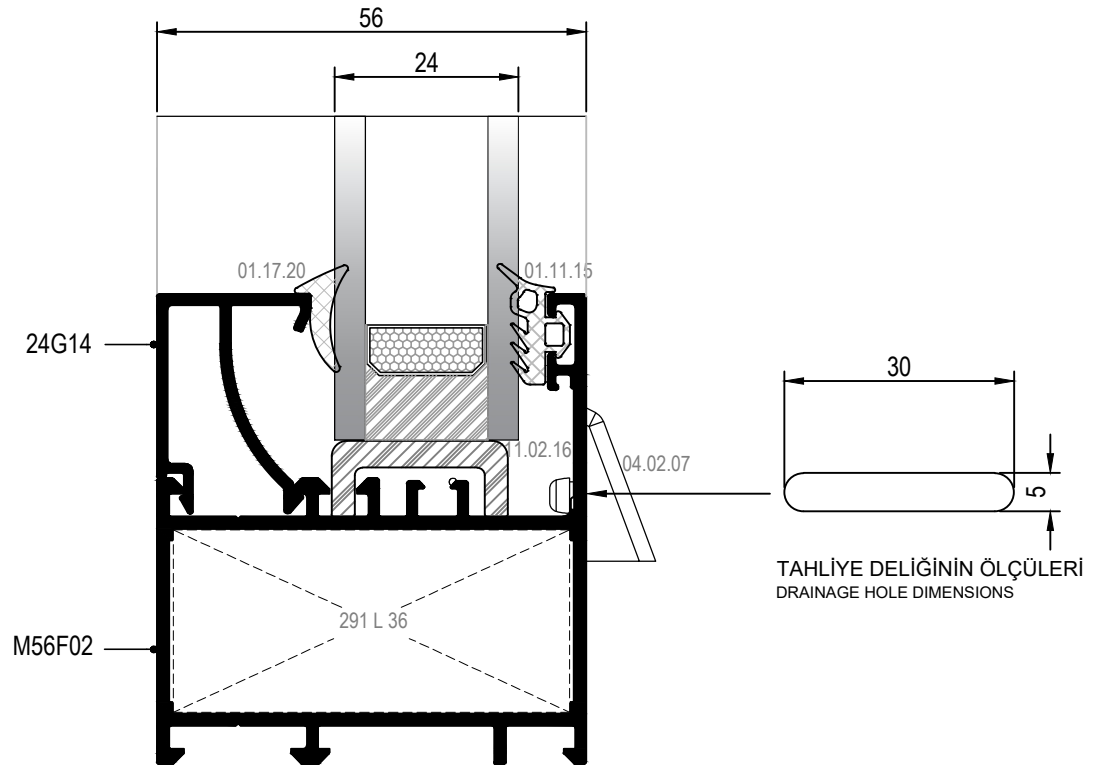

② DETAYI
DETAIL

DIŞ
(OUTSIDE) →

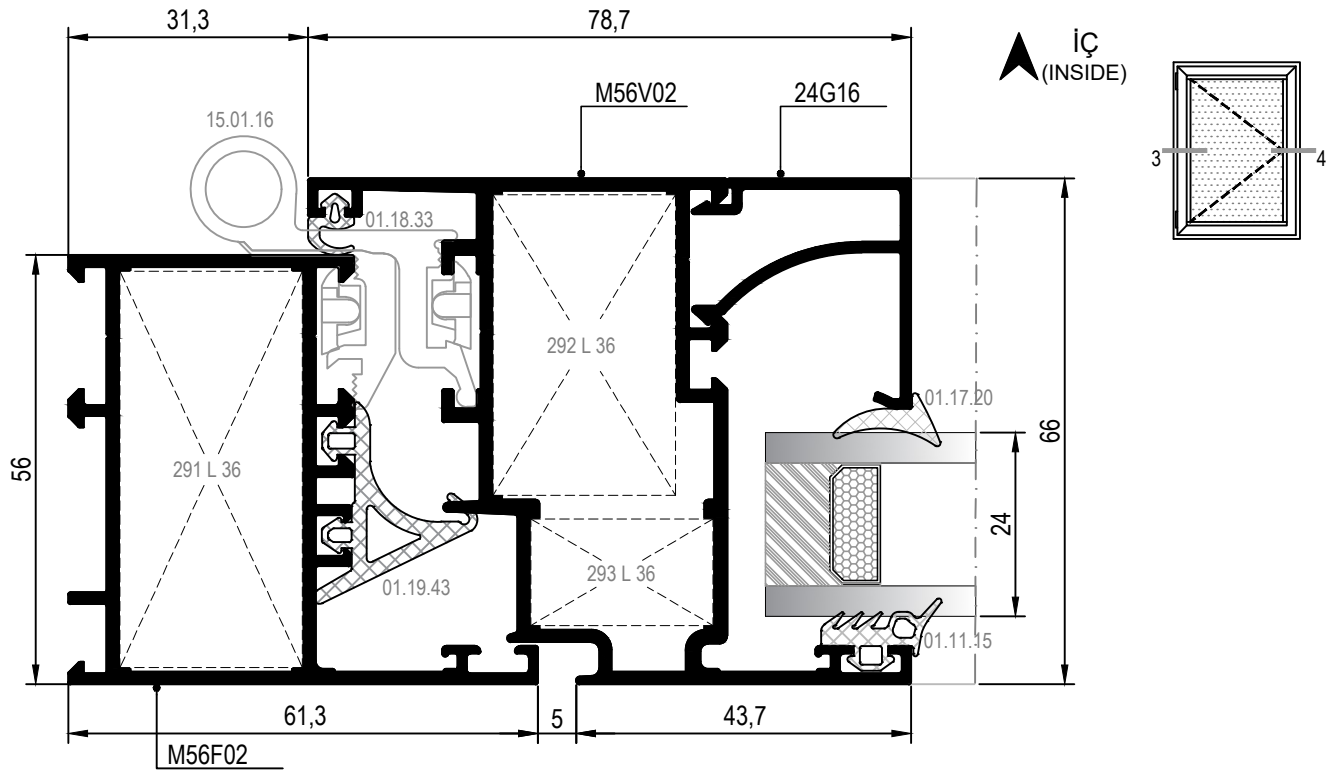

③ DETAYI
DETAIL

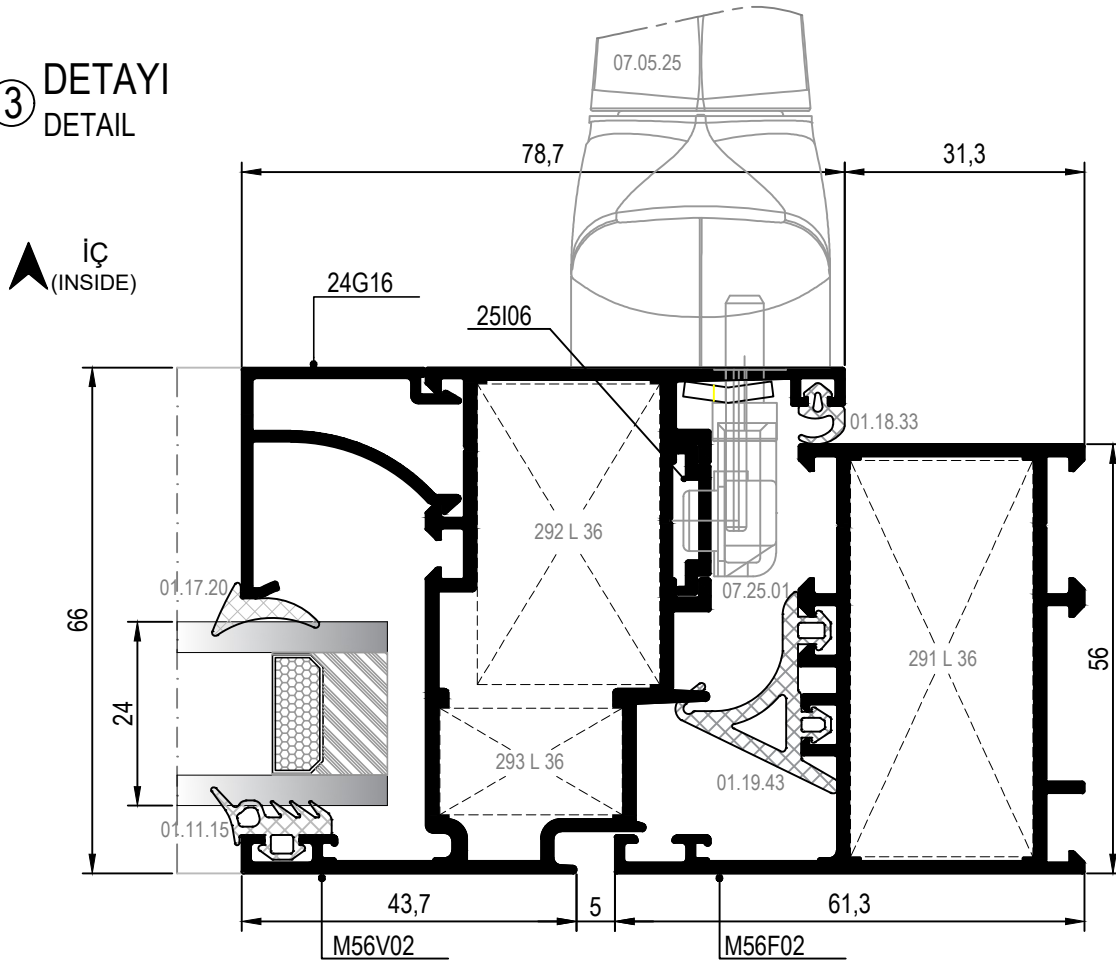

④ DETAYI
DETAIL

DIŞ (OUTSIDE) ➔

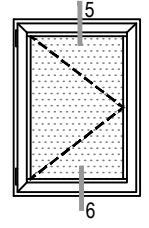
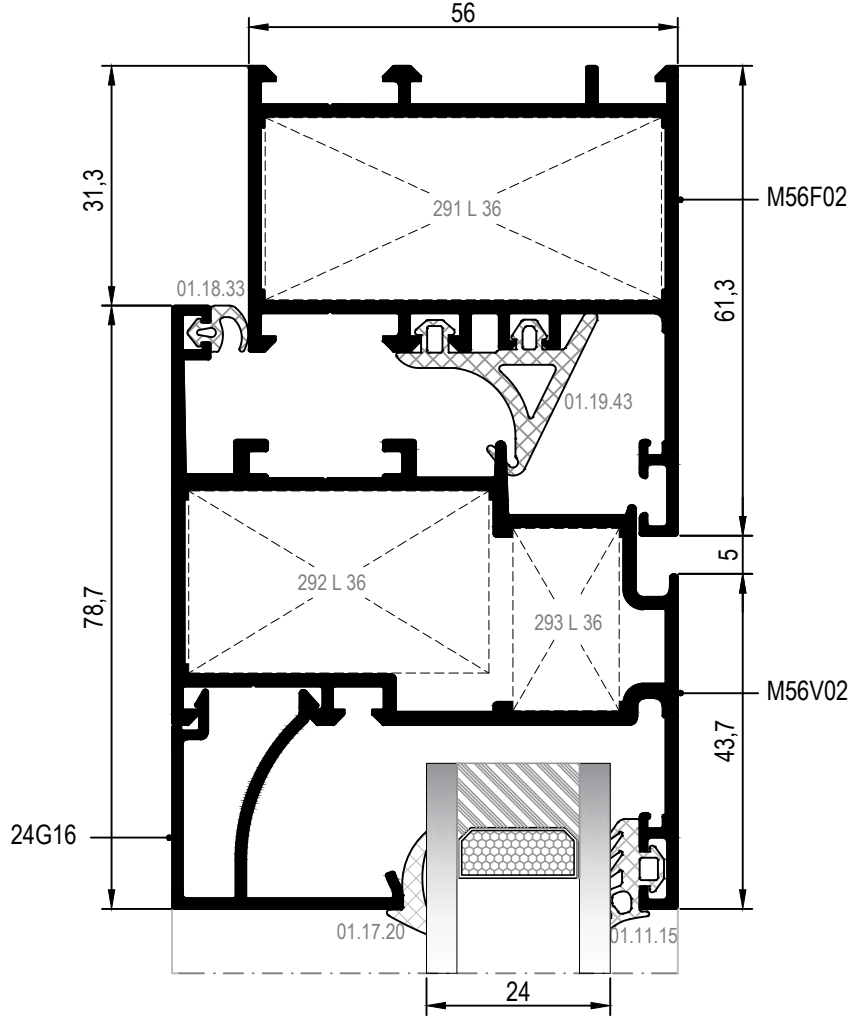

⑤ DETAYI
DETAIL

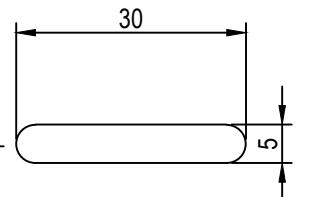
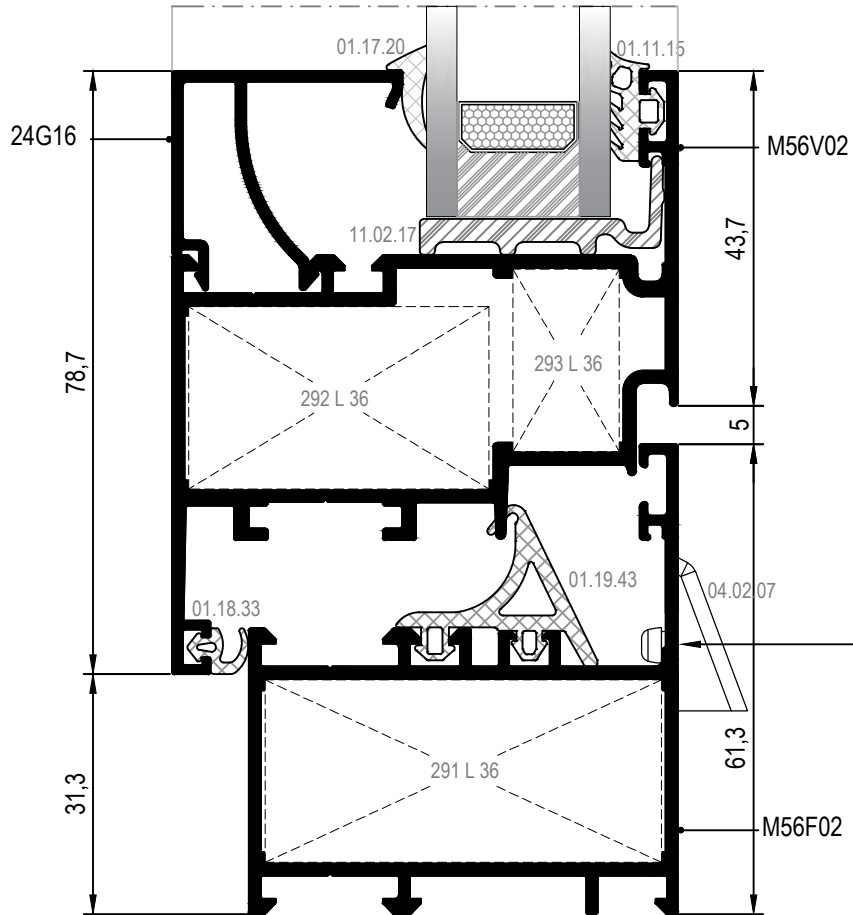

TAHLİYE DELİĞİNİN ÖLÇÜLERİ
DRAINAGE HOLE DIMENSIONS

⑥ DETAYI
DETAIL

DIŞ
(OUTSIDE) ➔

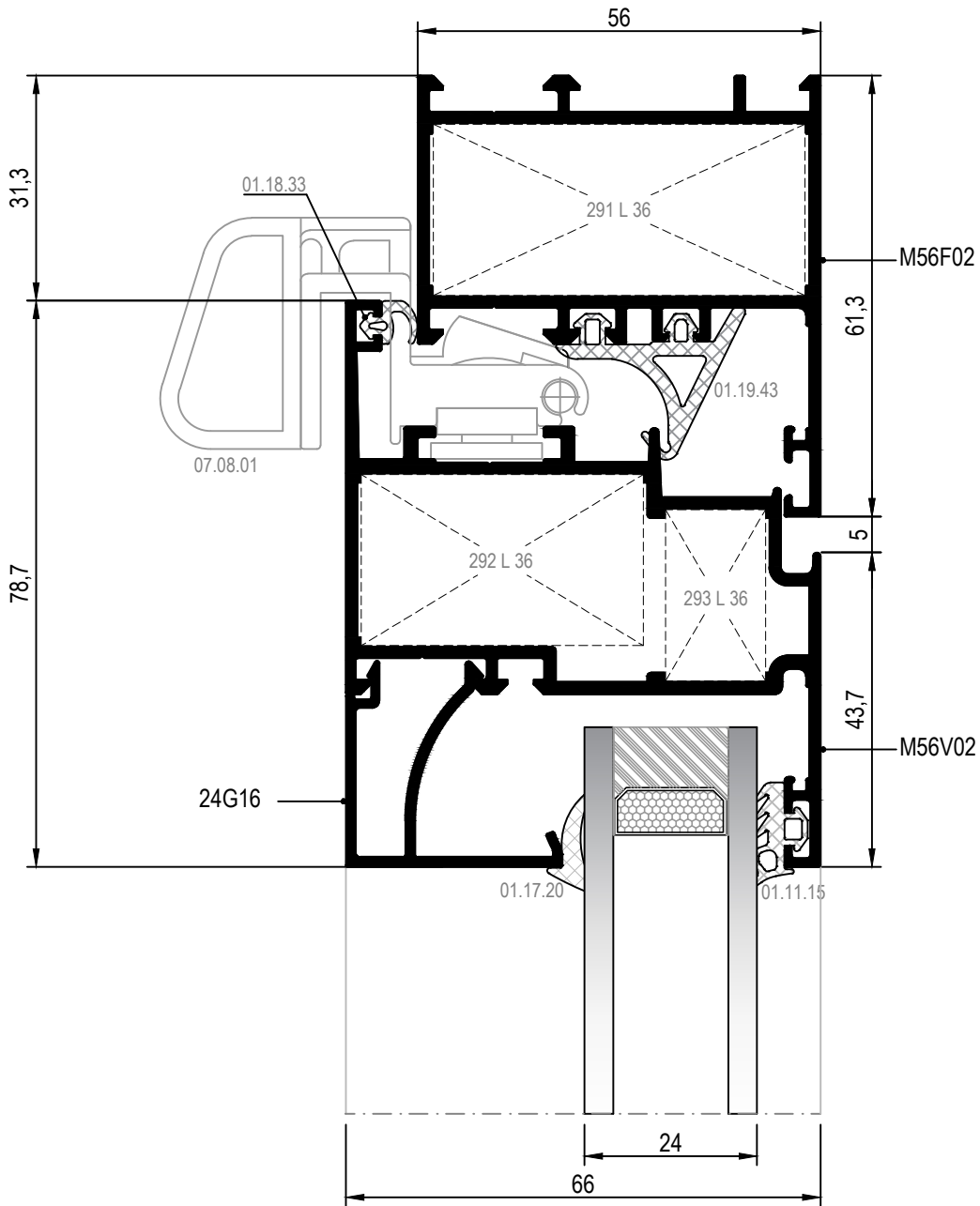
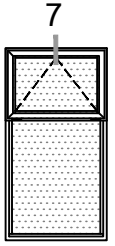

⑦ DETAYI
DETAIL

DIŞ
(OUTSIDE) ➔

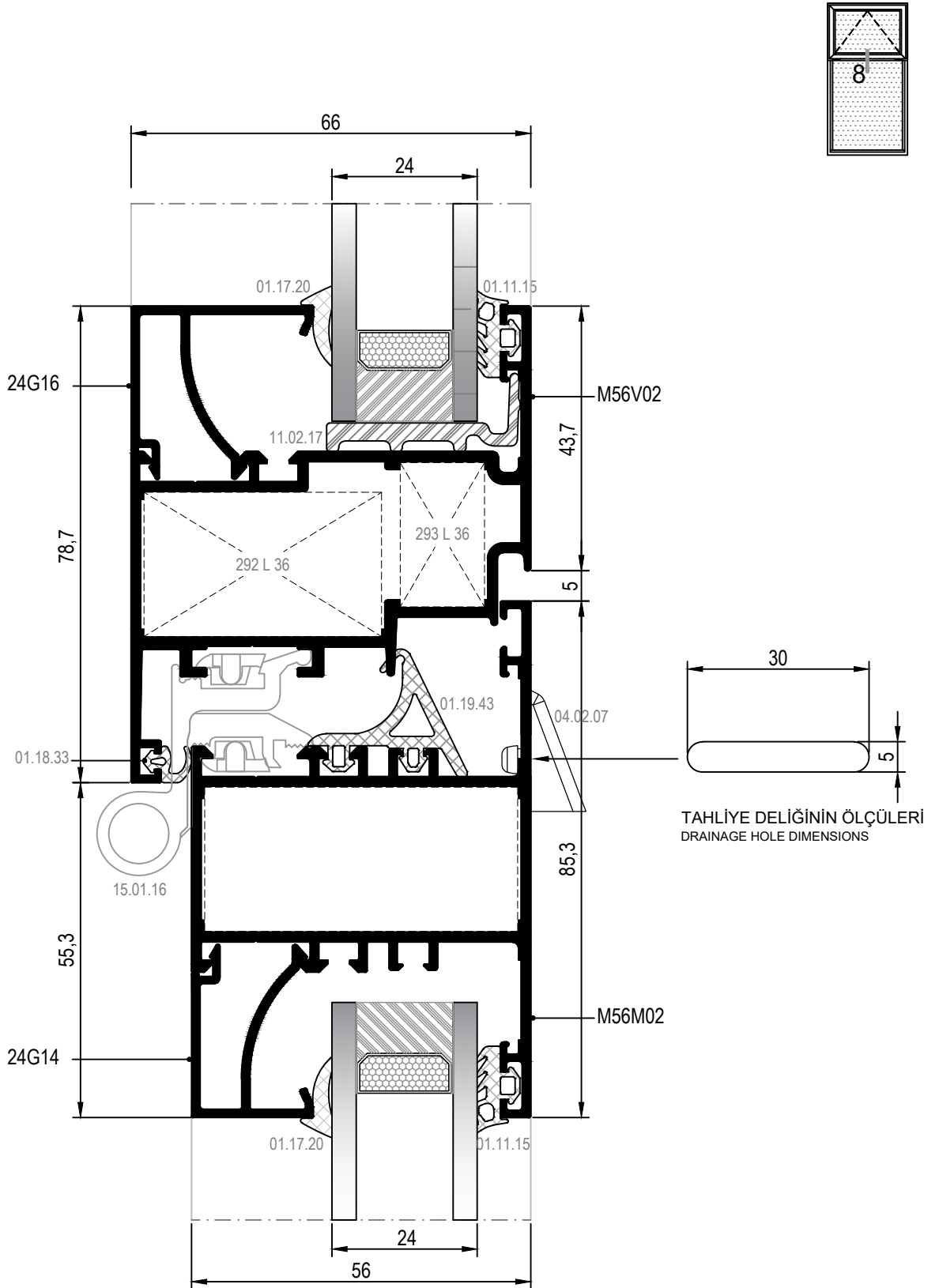

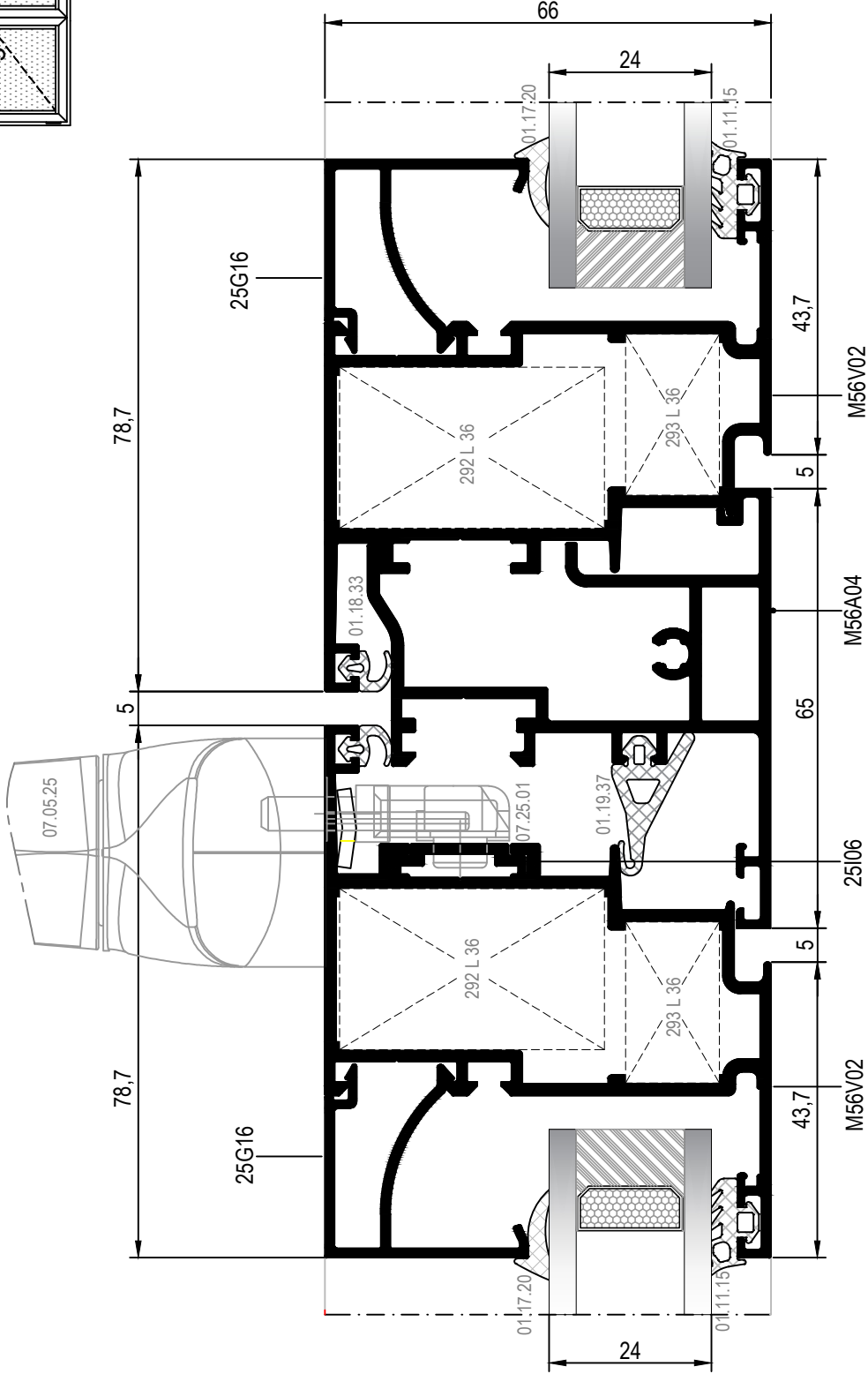
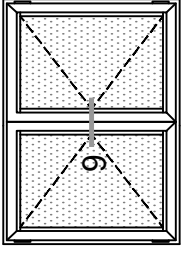

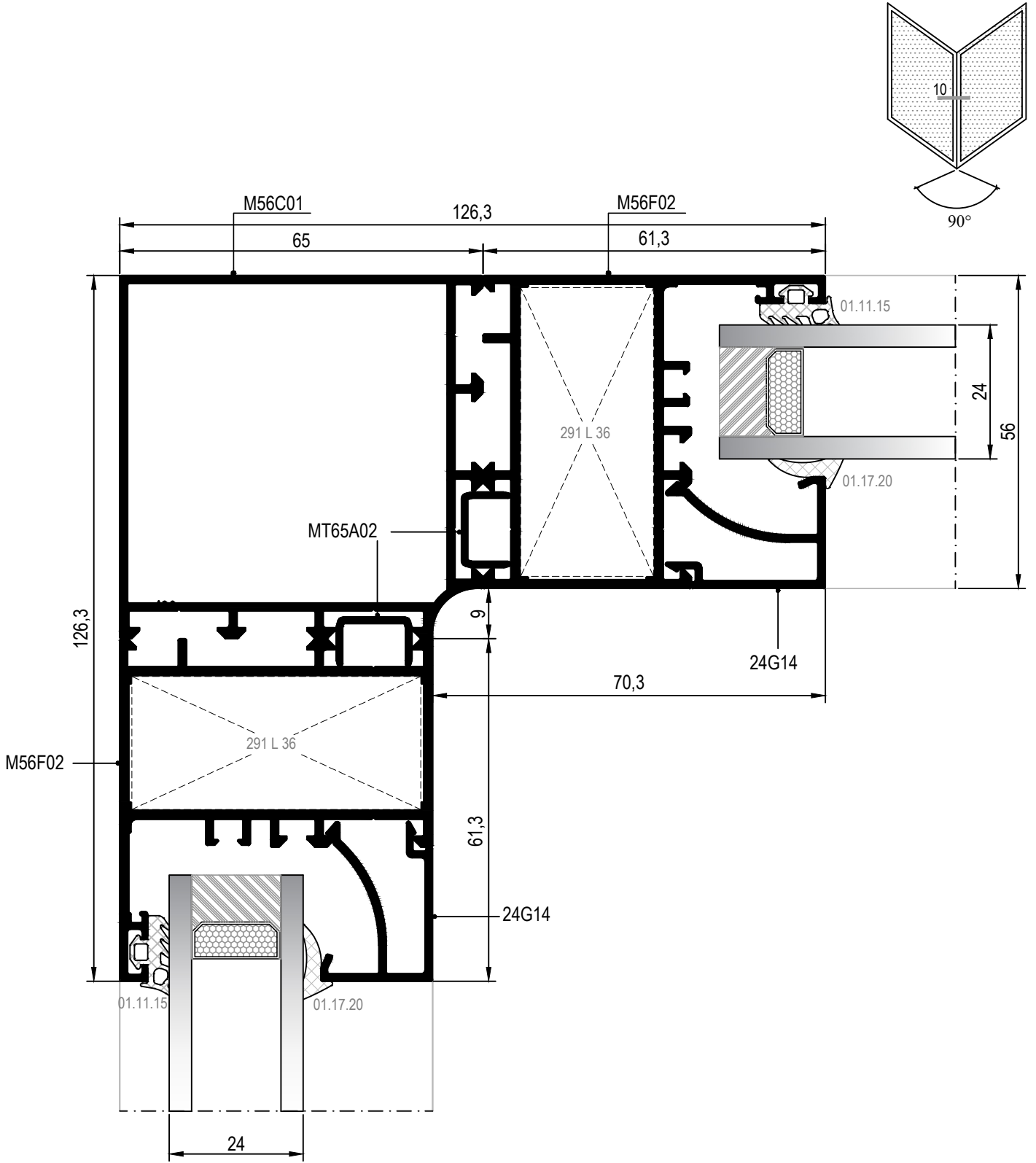

⑩ DETAYI
DETAIL

İÇ
(INSIDE) ➔

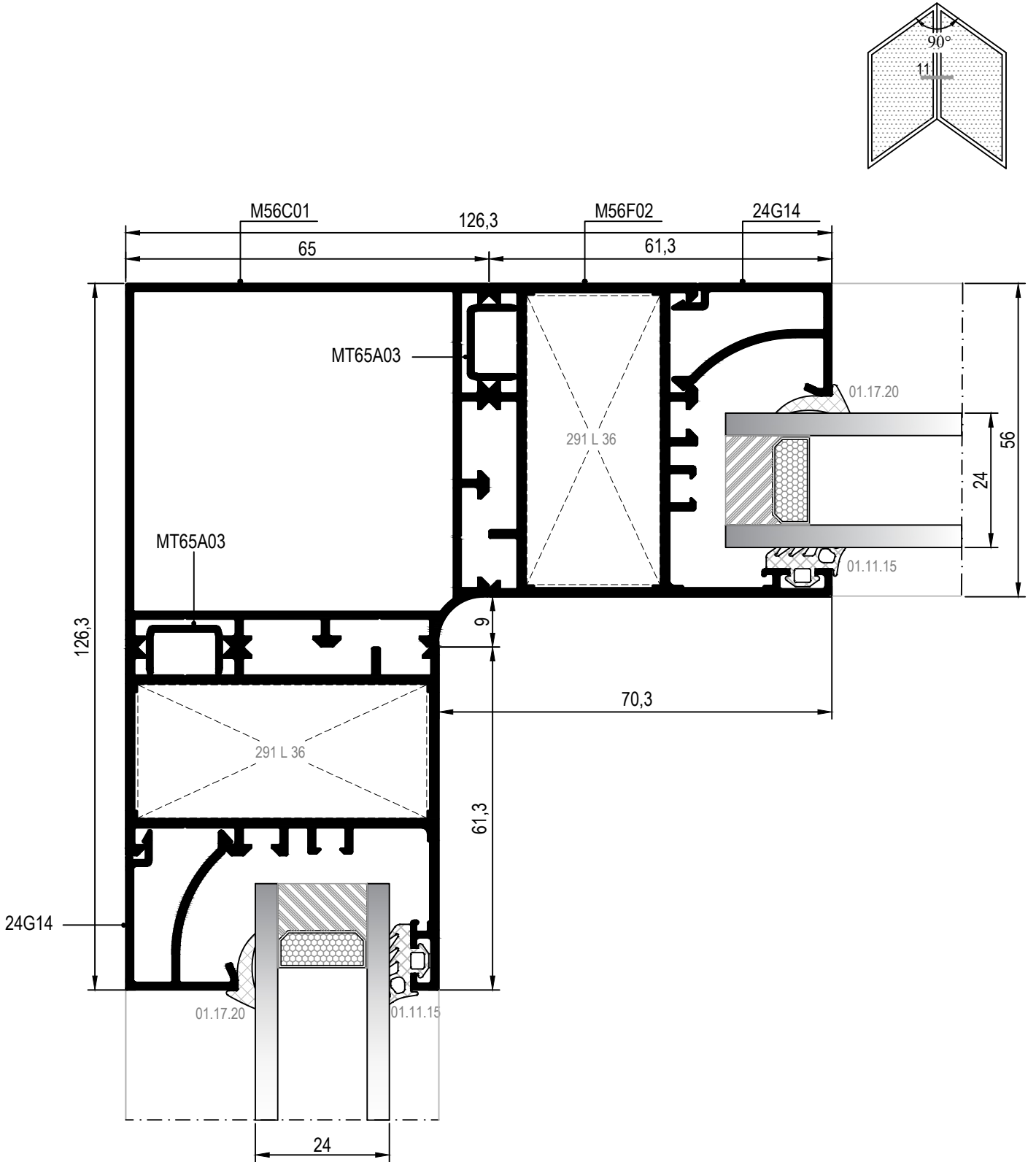

① DETAYI
DETAIL

DIŞ
(OUTSIDE) ➔

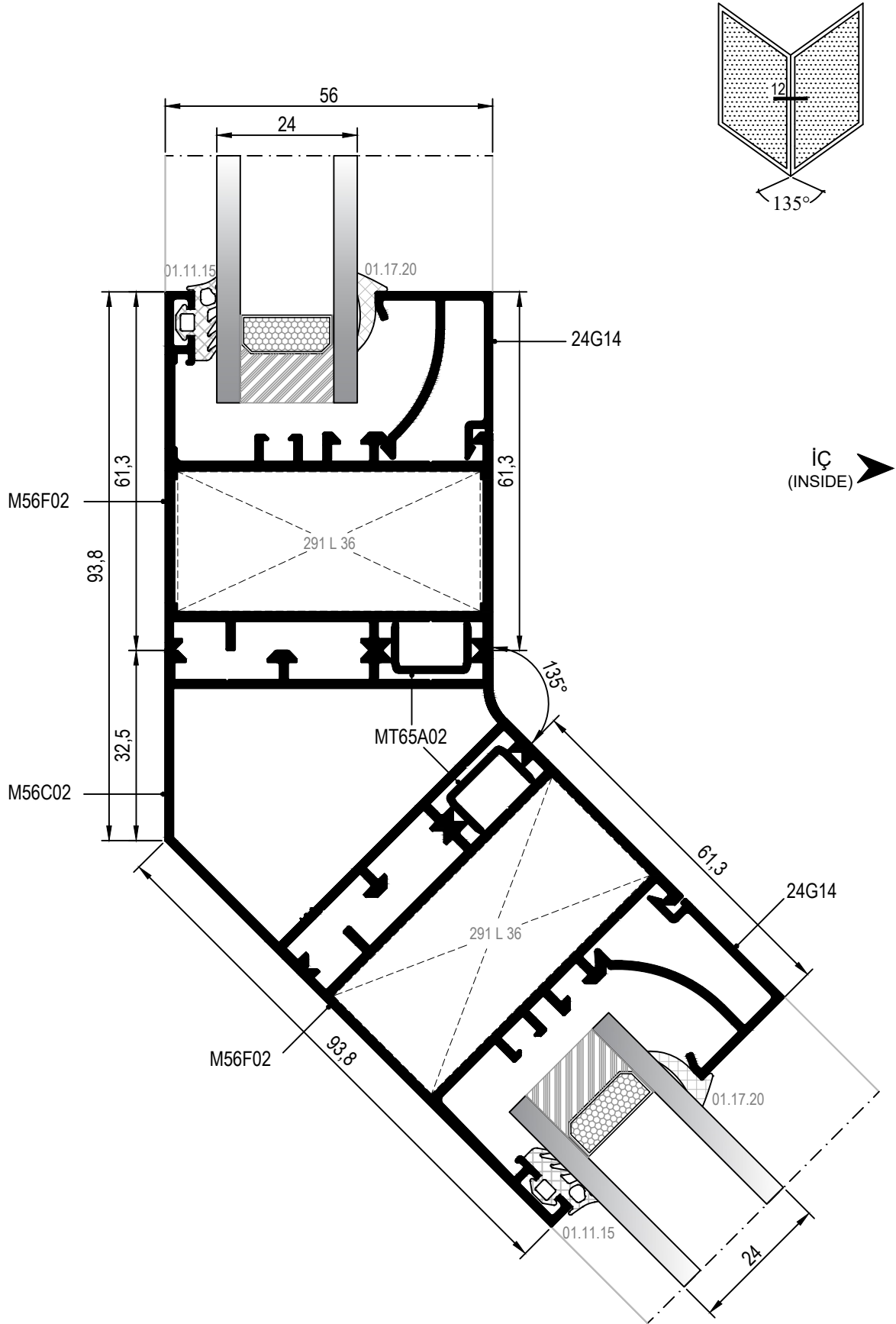

OVAL SERİ DETAYLARI
OVAL SYSTEM DETAILS

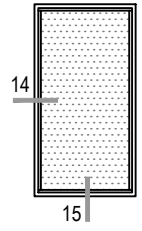
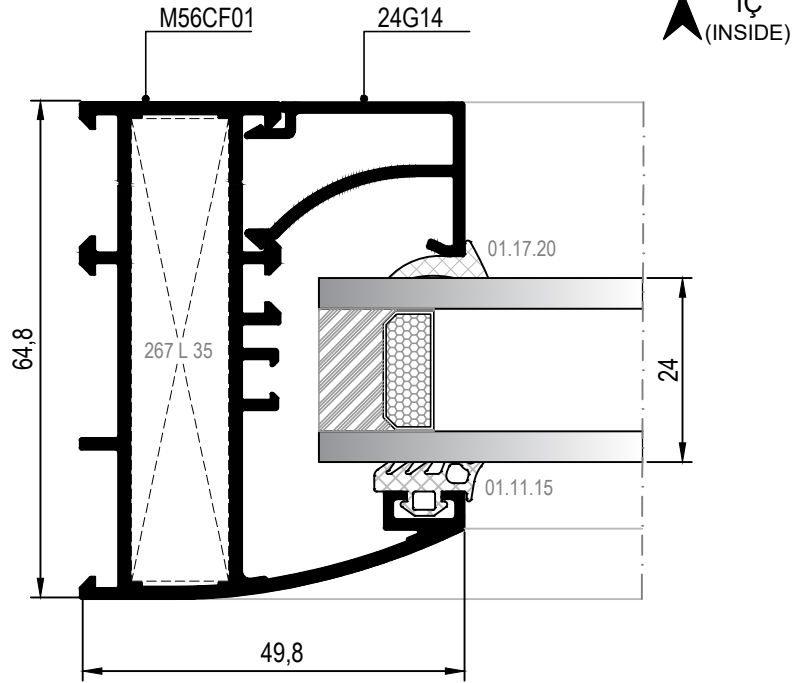

14 DETAYI
DETAIL

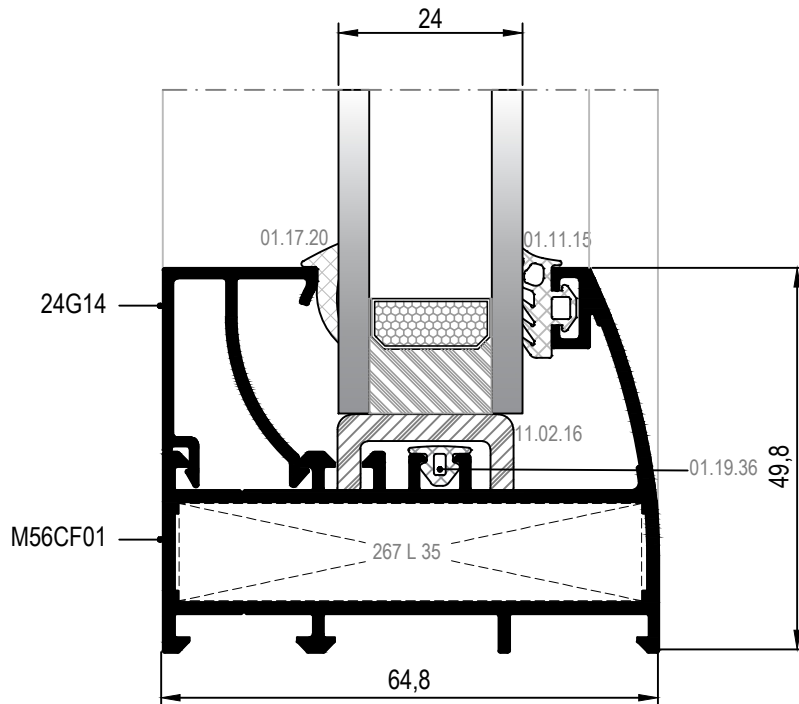

15 DETAYI
DETAIL

DIŞ
(OUTSIDE) →

OVAL SERİ DETAYLARI
OVAL SYSTEM DETAILS

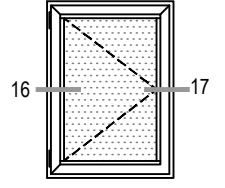
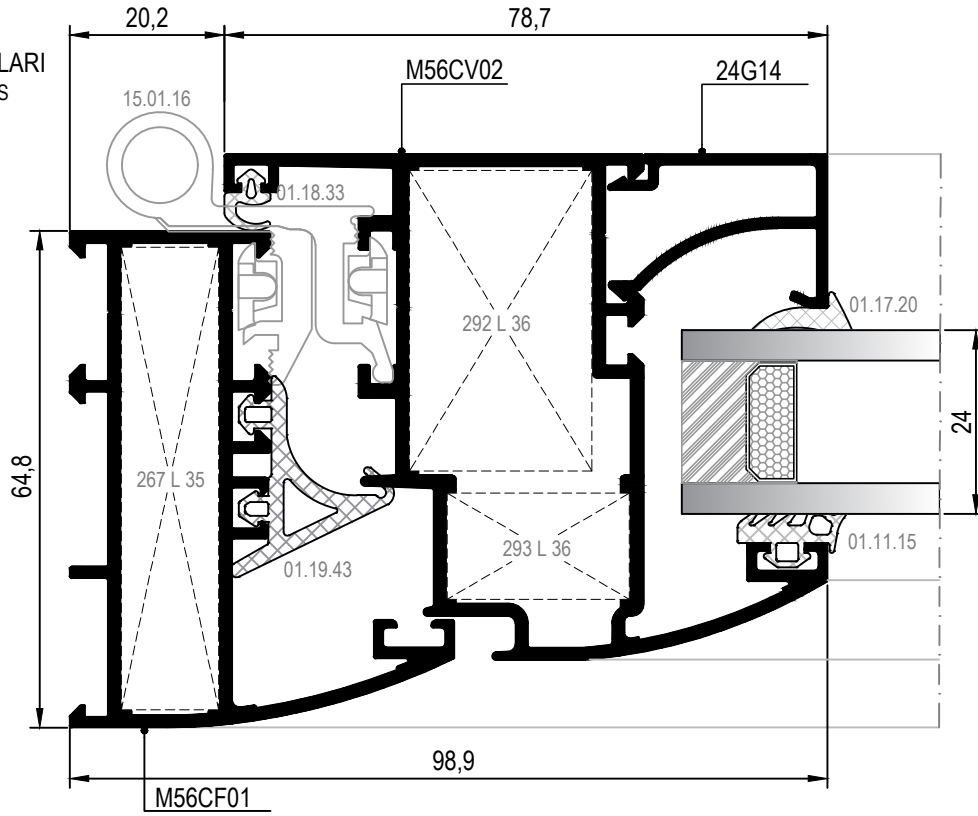

İÇ
(INSIDE)

16 DETAYI
DETAIL

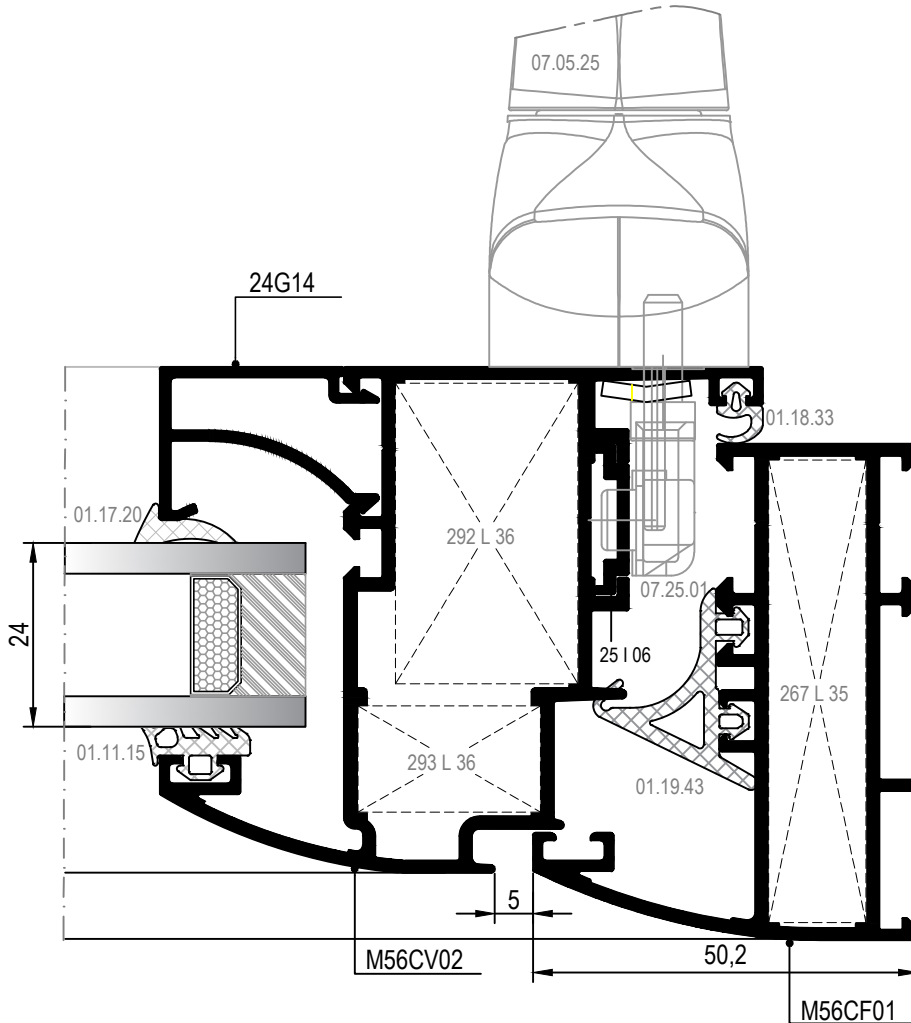

İÇ
(INSIDE)

17 DETAYI
DETAIL

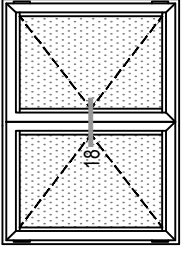

OVAY SERI DEYAYLARI
OVAY SYSTEM DETAILS

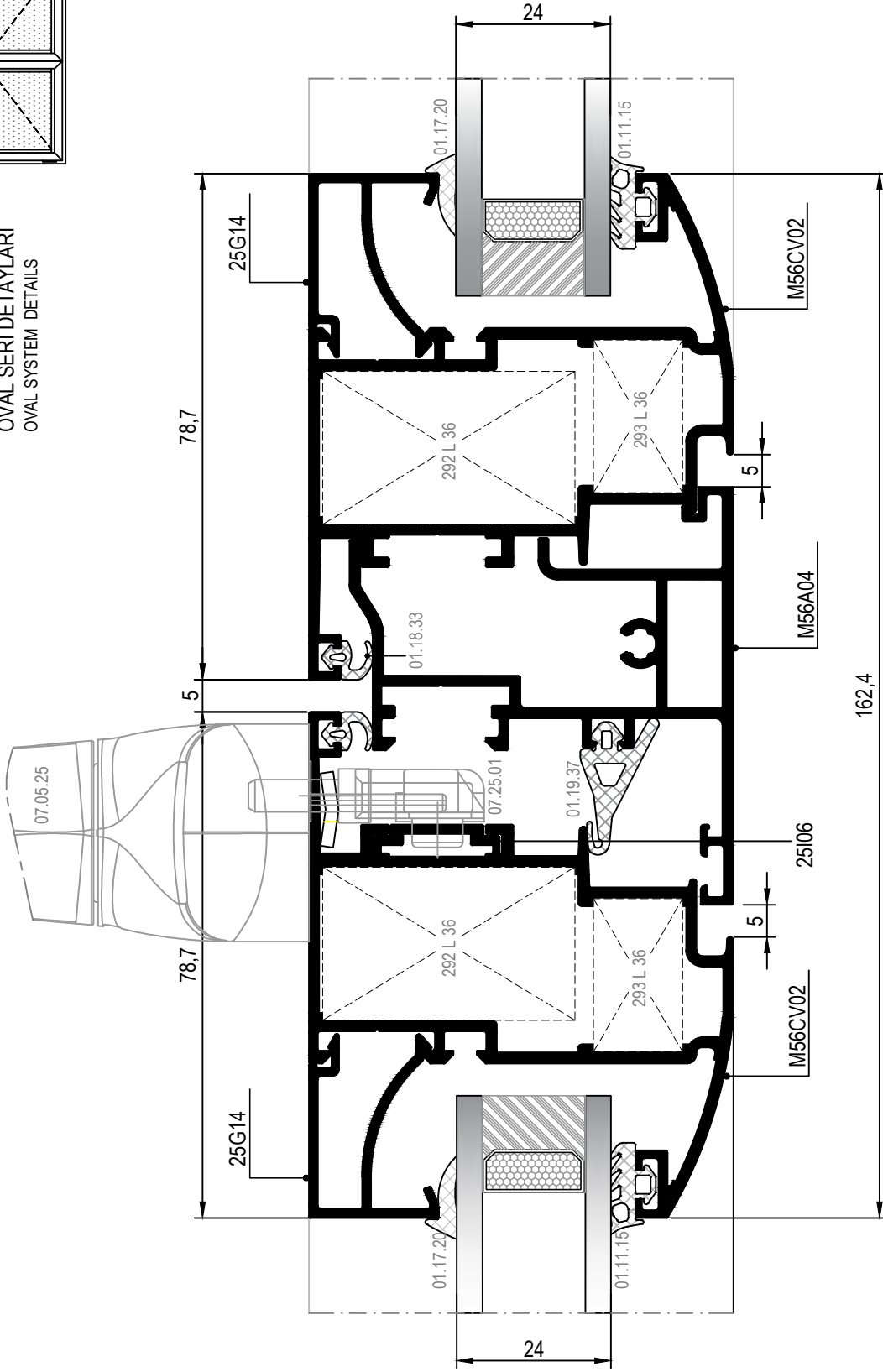

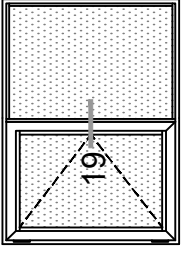

OVAL SERİ DETAYLARI
OVAL SYSTEM DETAILS

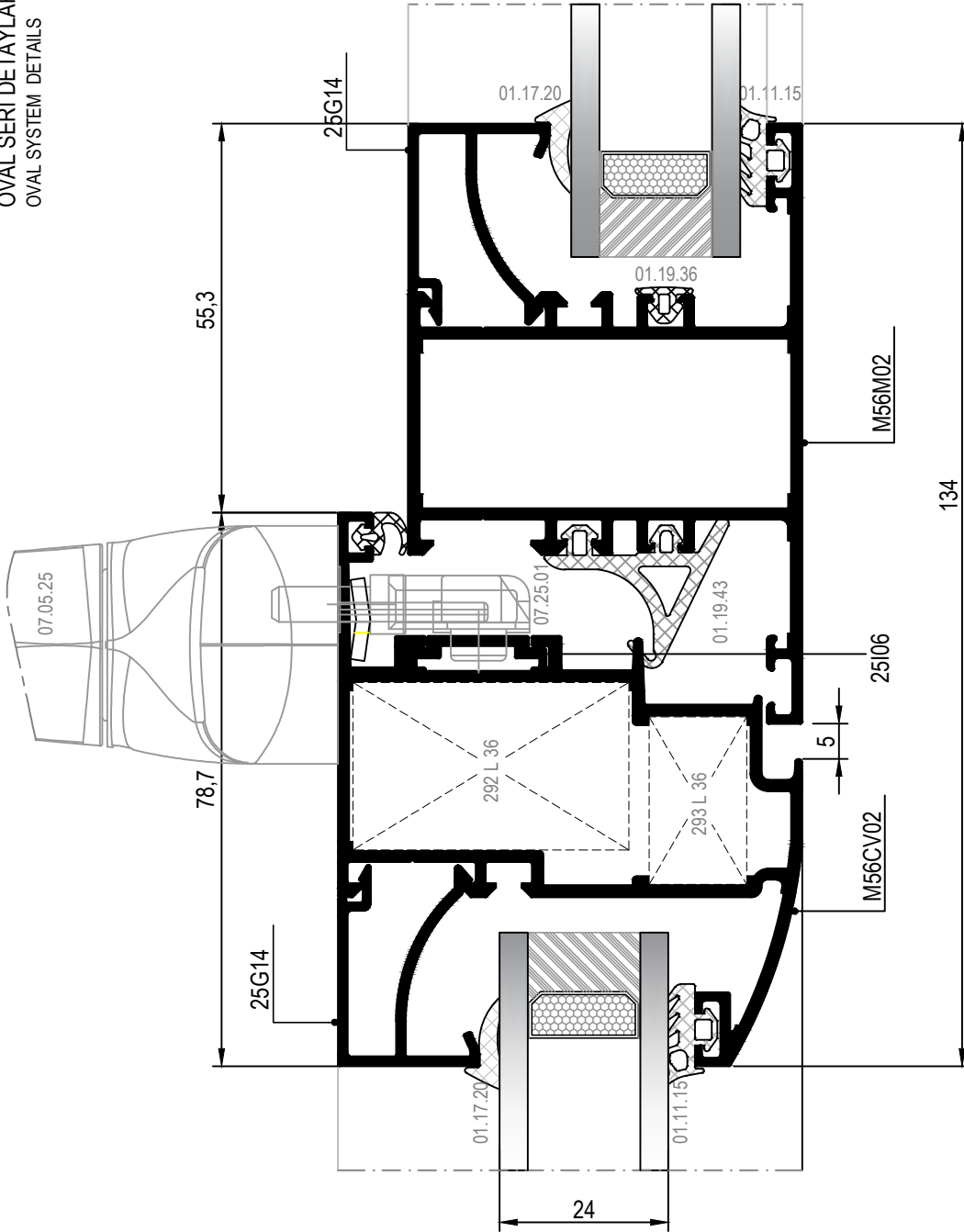

İÇE AÇILIM HEMYÜZ KAPI DETAYLARI
INWARD OPENING FLUSH DOOR DETAILS

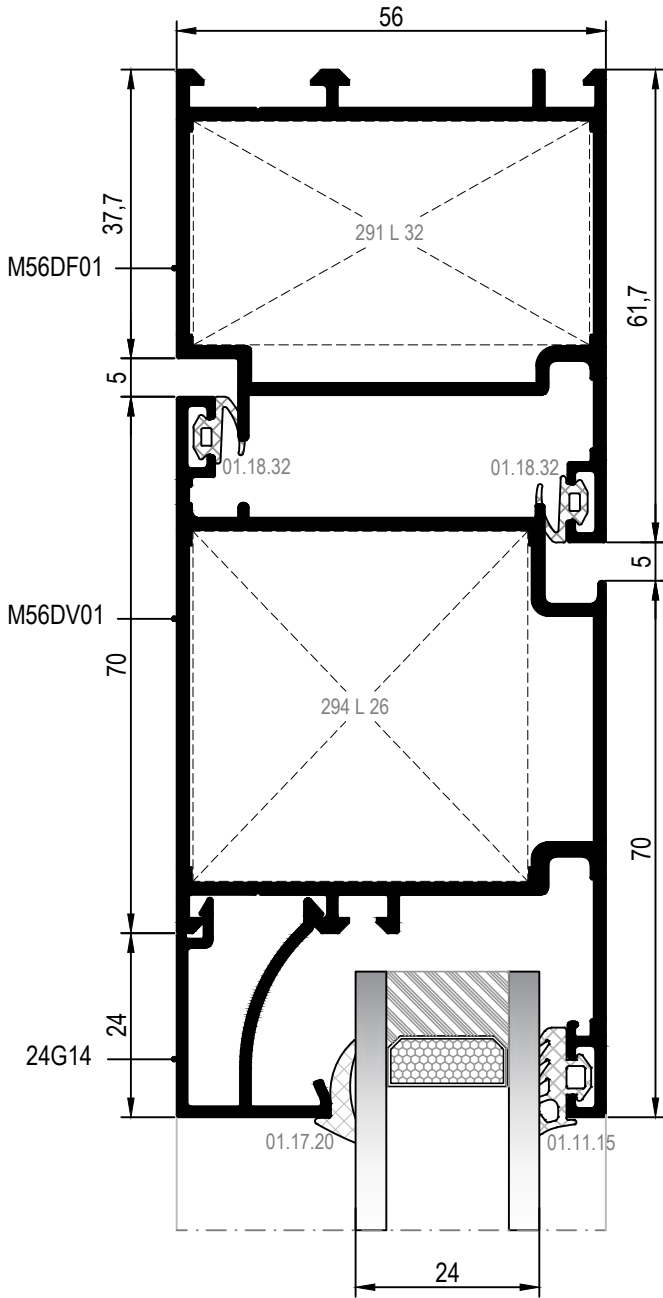

22 DETAYI
DETAIL

23 DETAYI
DETAIL

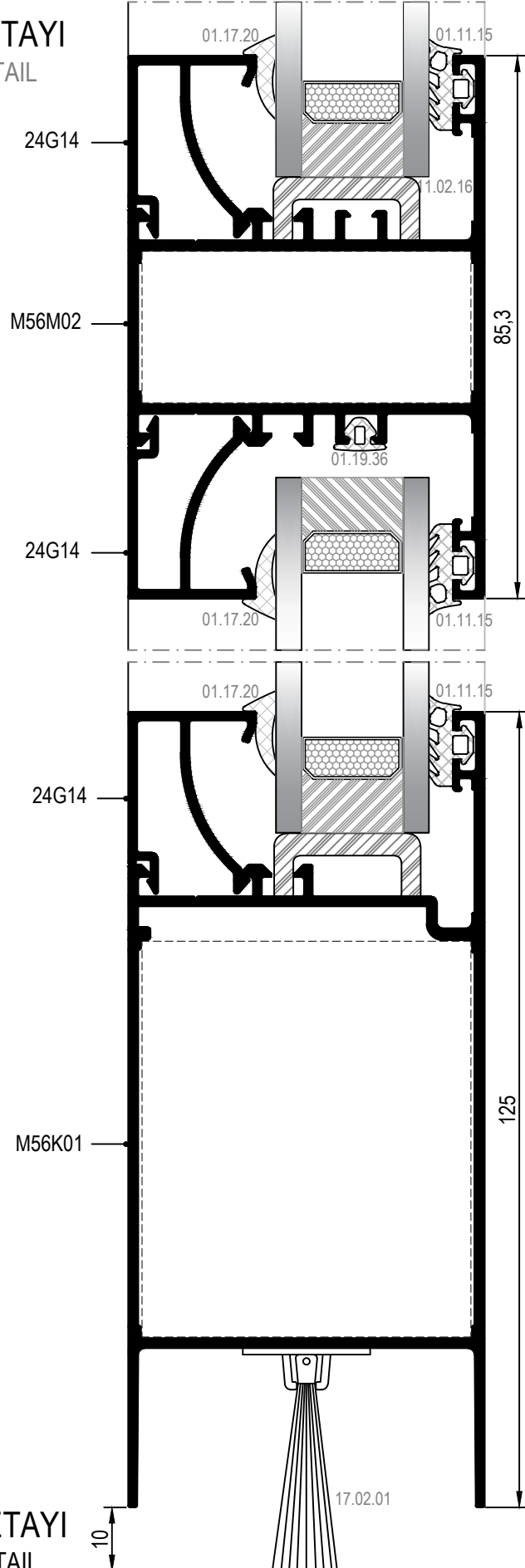

24 DETAYI
DETAIL

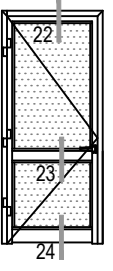

İÇE AÇILIM ADAPTÖRLÜ HEMYÜZ KAPI DETAYLARI
INWARD OPENING FLUSH DOOR DETAILS WITH ADAPTER

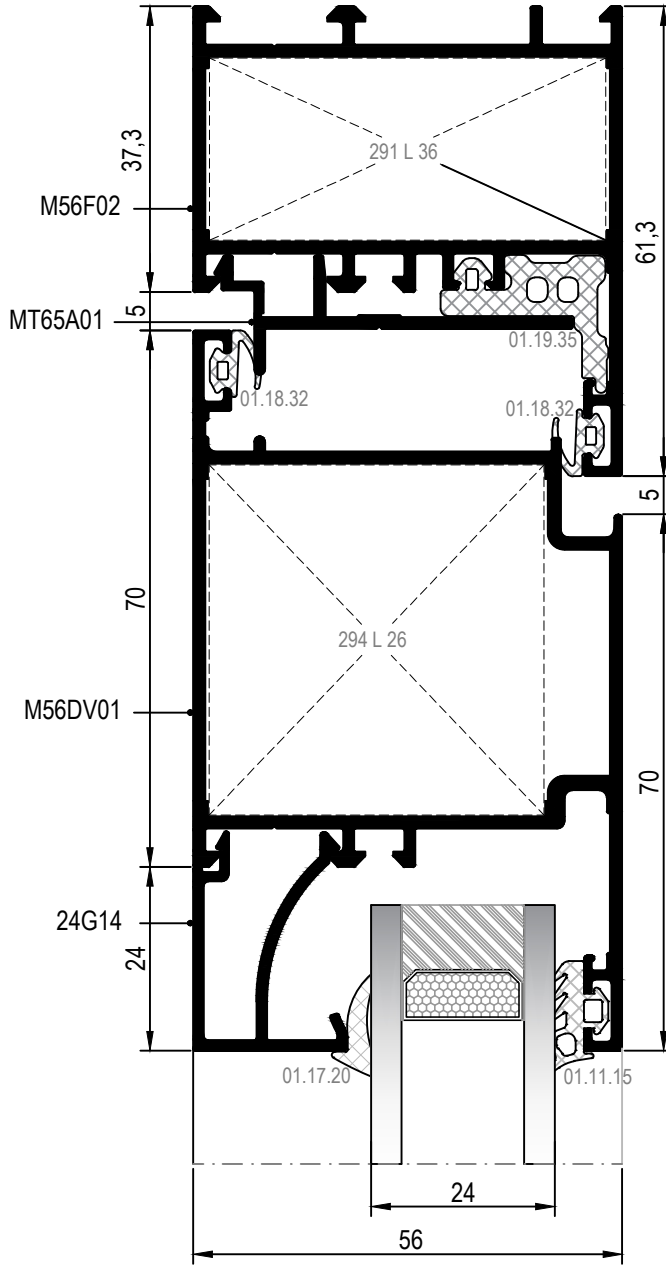
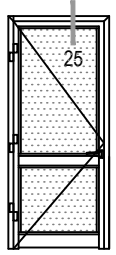

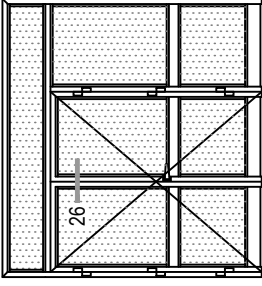

İÇE AÇILIM ADAPTÖRLÜ HEMYÜZ KAPI DETAYLARI
INWARD OPENING FLUSH DOOR DETAILS WITH ADAPTER

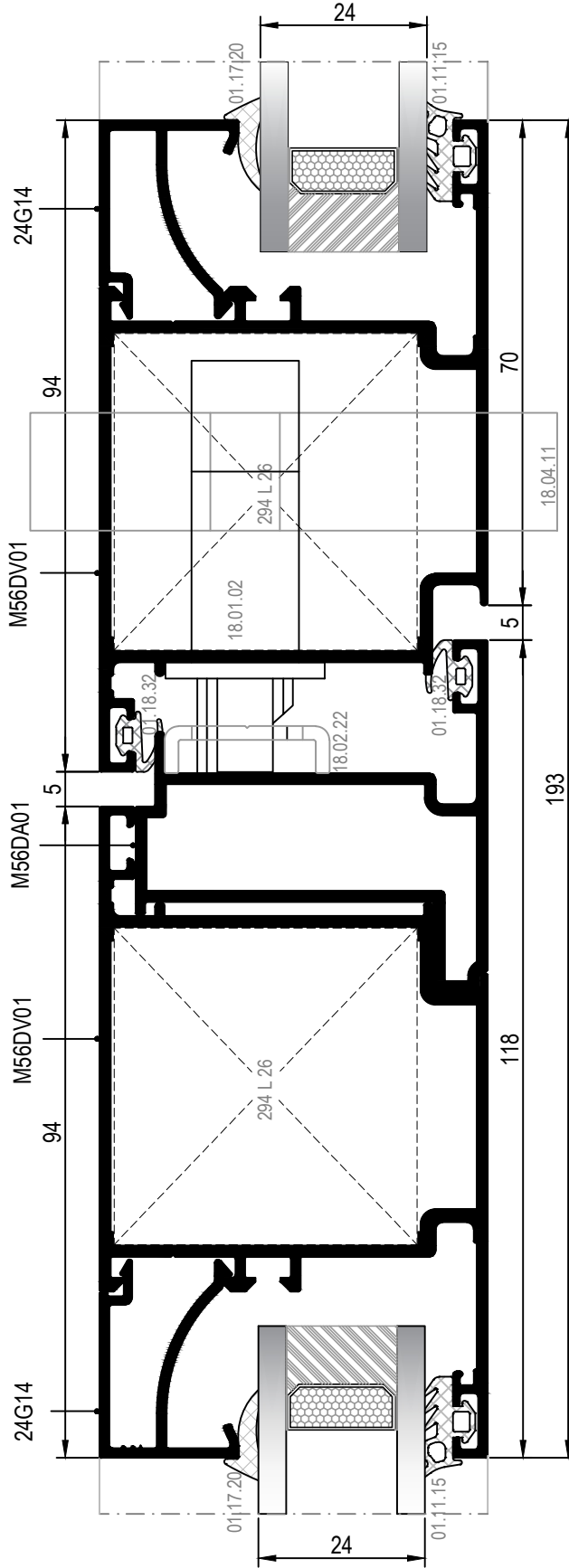

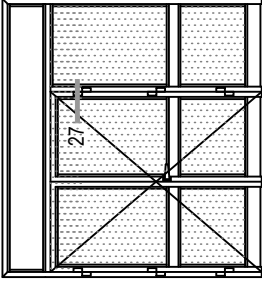

İÇE AÇILIM ADAPTÖRLÜ HEMİYÜZ KAPI DETAYLARI
INWARD OPENING FLUSH DOOR DETAILS WITH ADAPTER

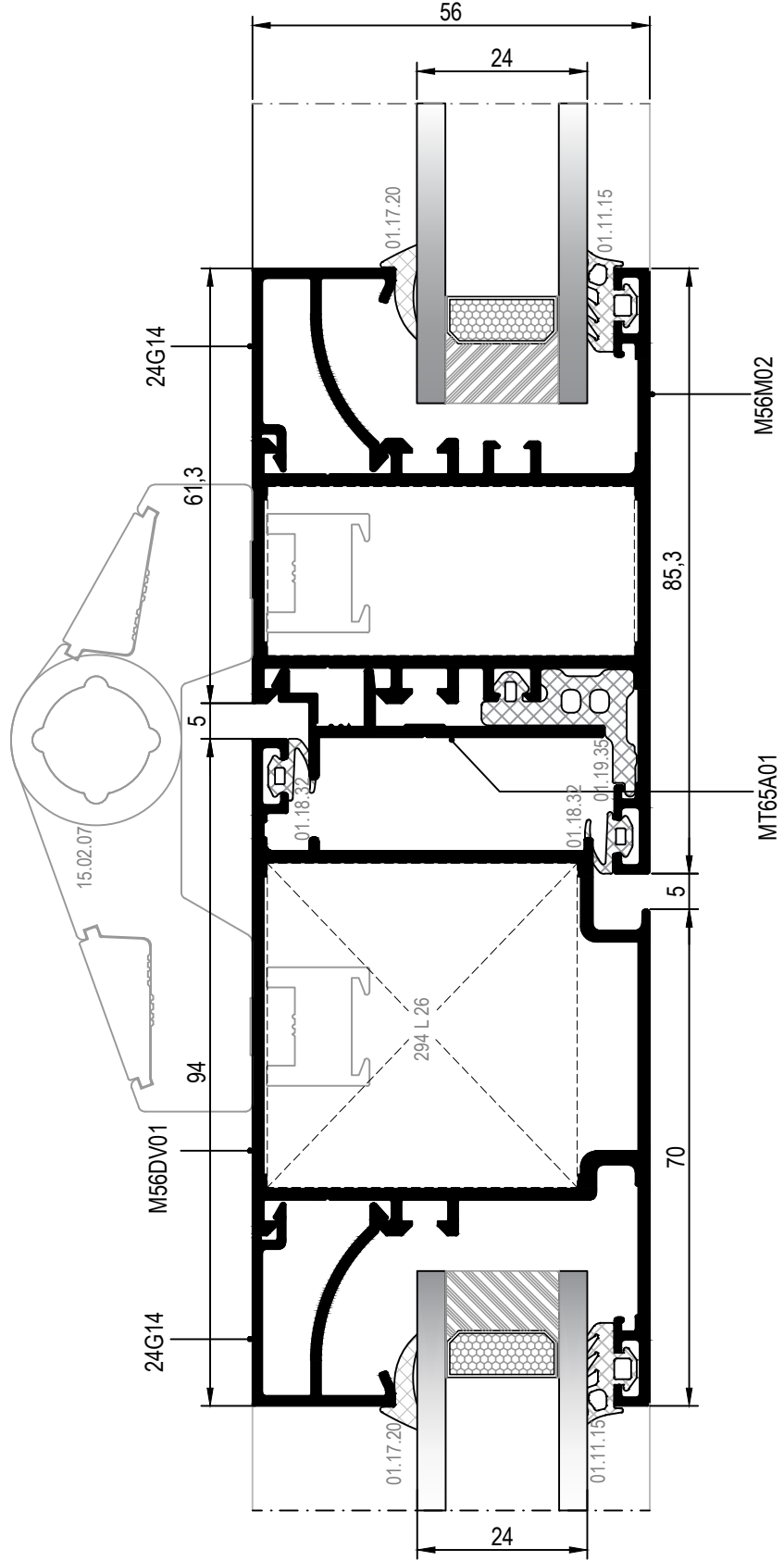

İÇE AÇILIM ADAPTÖRLÜ HEMYÜZ KAPI DETAYLARI
INWARD OPENING FLUSH DOOR DETAILS WITH ADAPTER

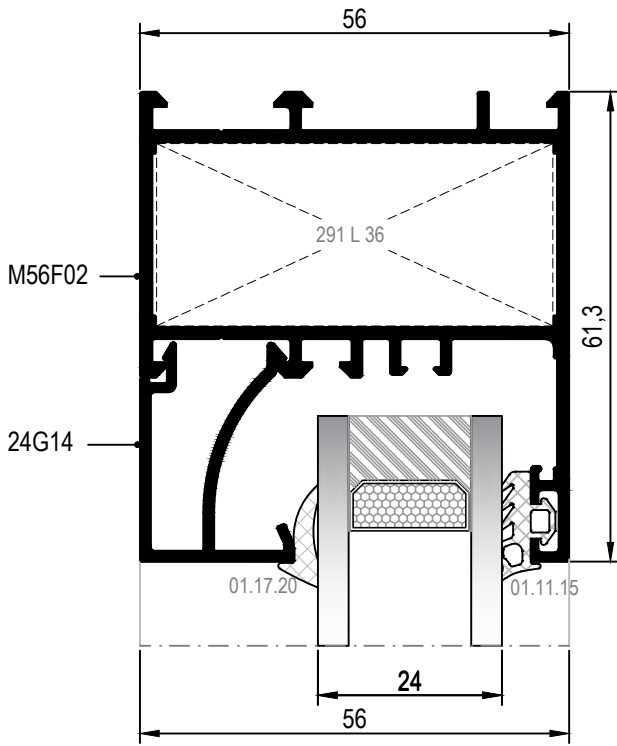
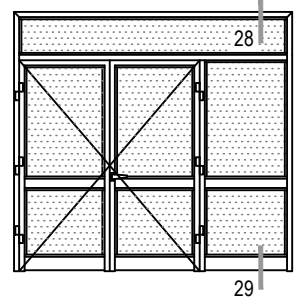

28 DETAYI
DETAIL

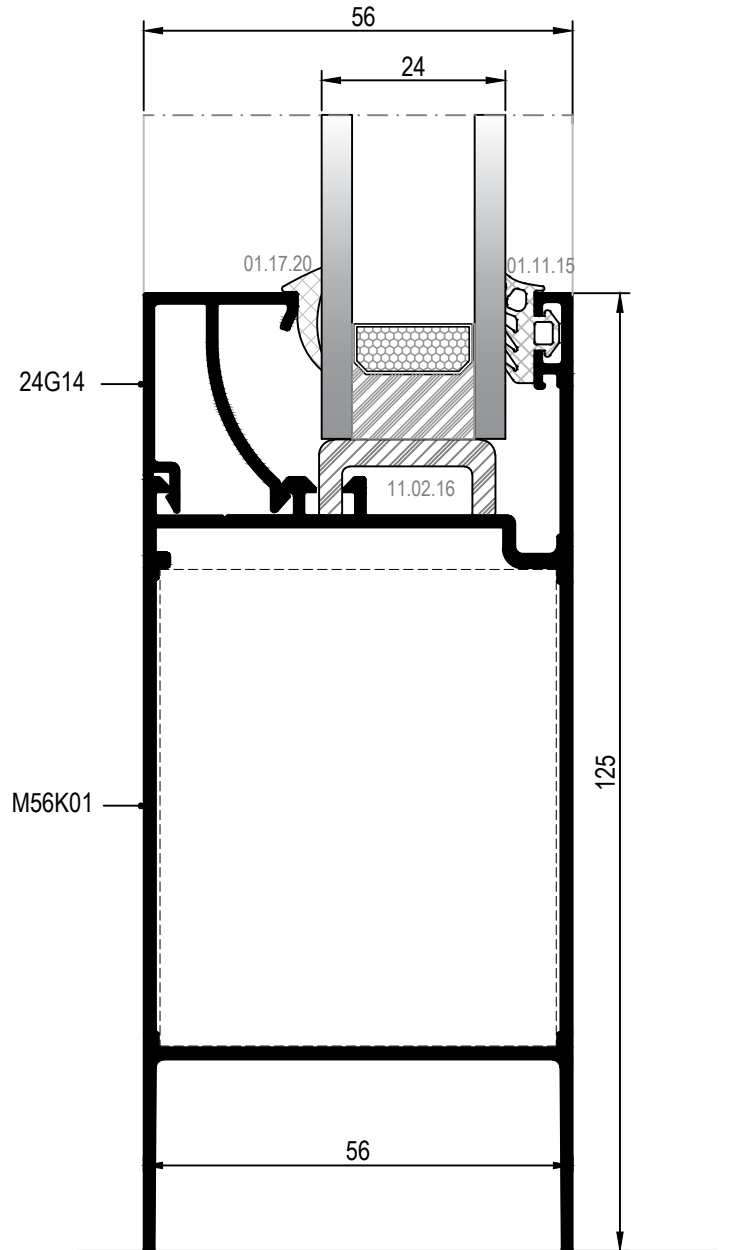

29 DETAYI
DETAIL

DIŞ
(OUTSIDE) ➔

İÇE AÇILIM ADAPTÖRLÜ HEMYÜZ KAPI DETAYLARI
INWARD OPENING FLUSH DOOR DETAILS WITH ADAPTER

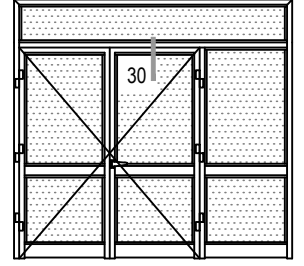
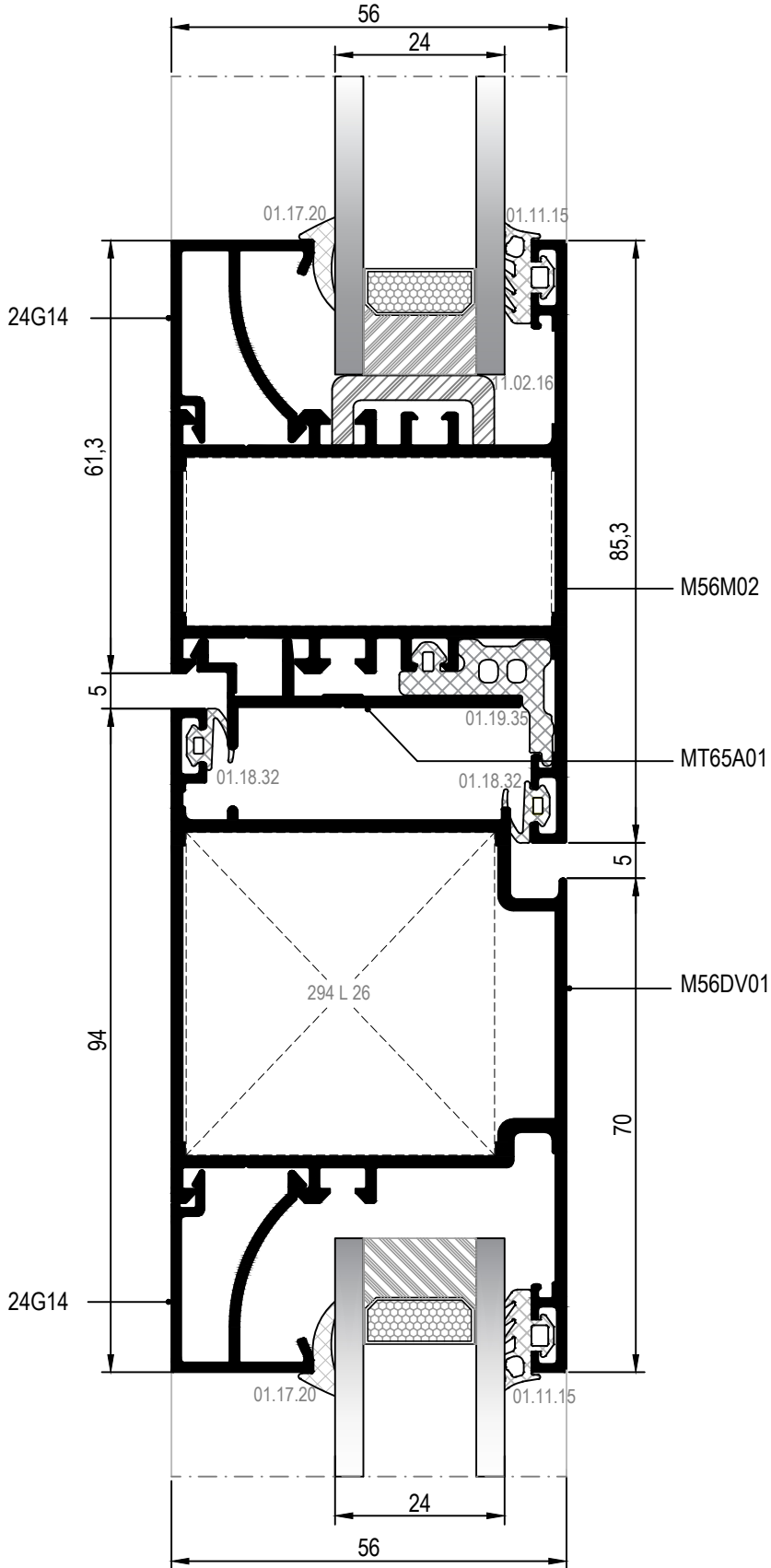

DIŐA AÇILIM HEMYÜZ KAPI DEYAYLARI
OUTWARD OPENING FLUSH DOOR DETAILS

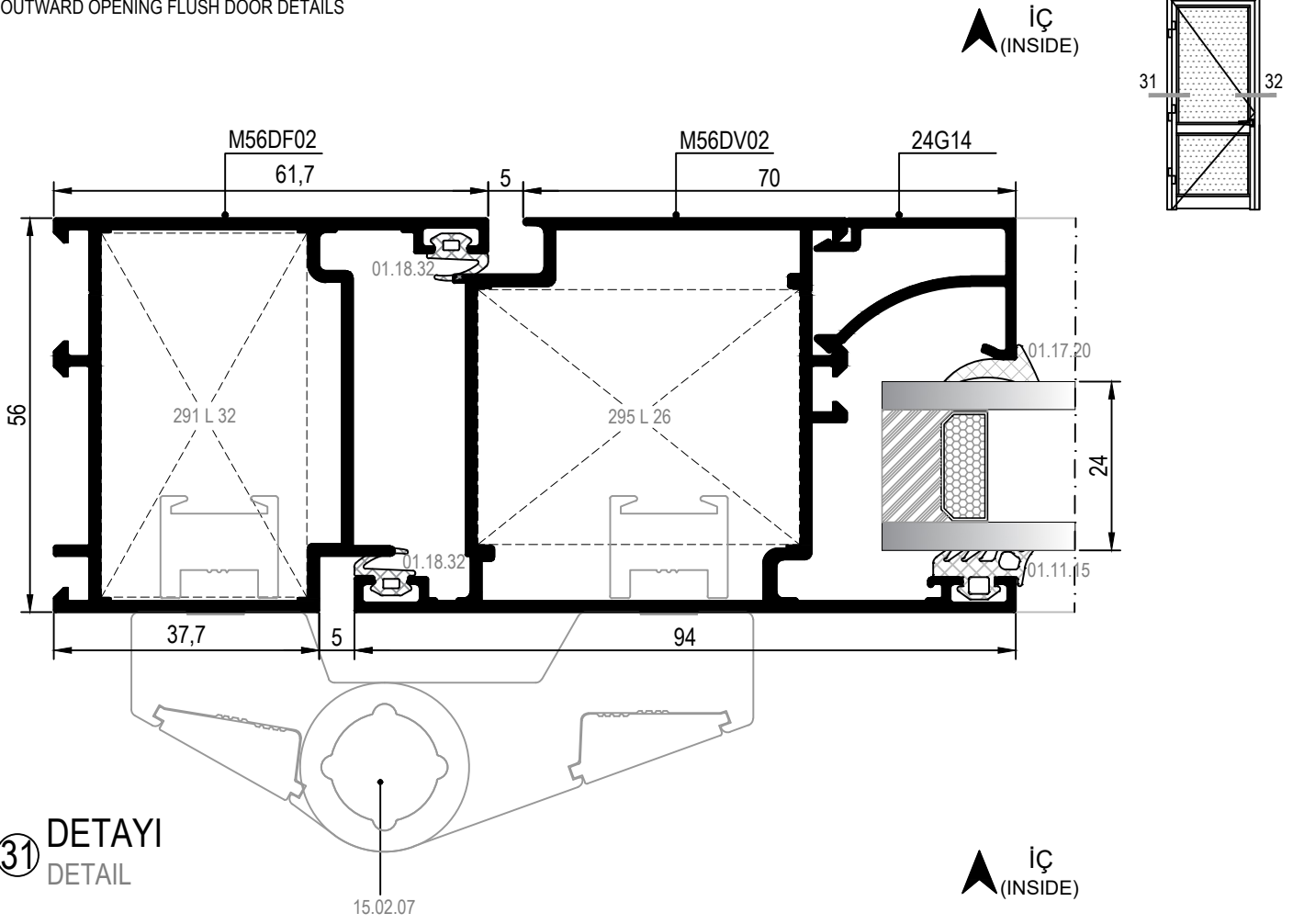

31 DEYAYI
DETAIL

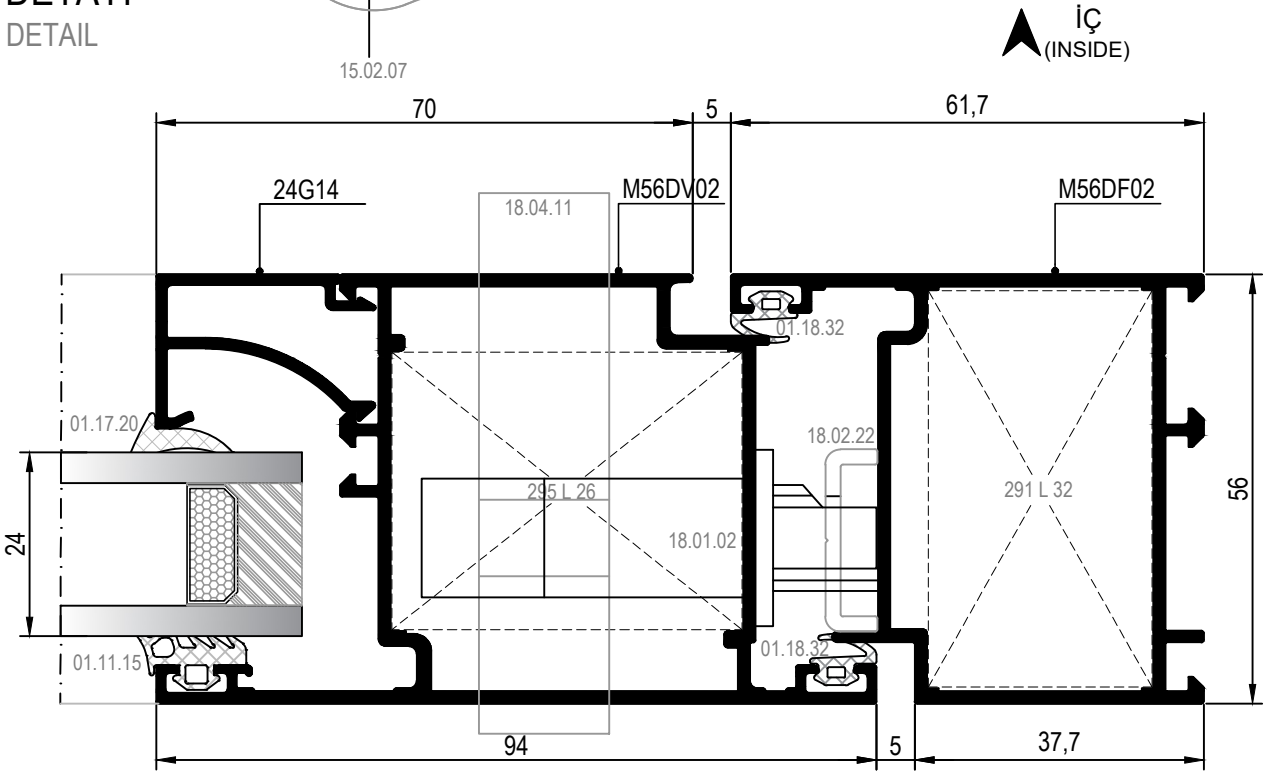

32 DEYAYI

DIŐ (OUTSIDE) ➔

DIŐA AÇILIM HEMYÜZ KAPI DEYAYLARI
OUTWARD OPENING FLUSH DOOR DETAILS

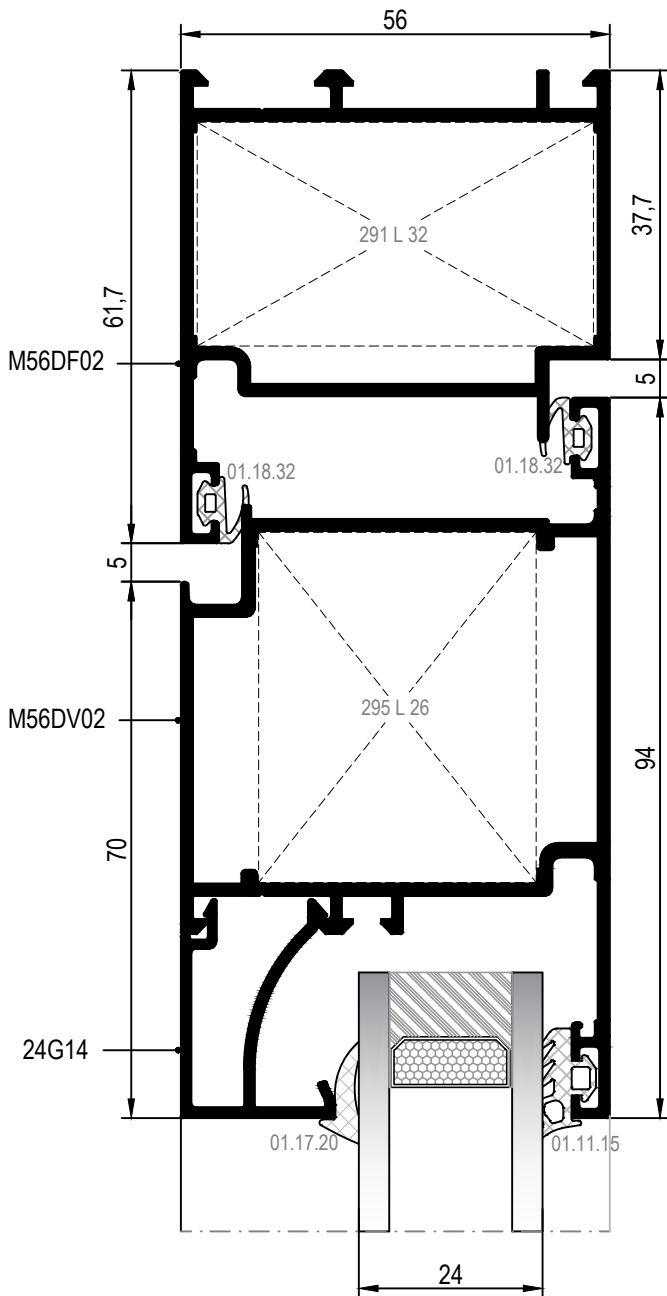
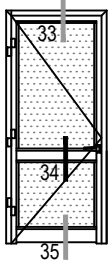

33 DETAYI
DETAIL

34 DETAYI
DETAIL

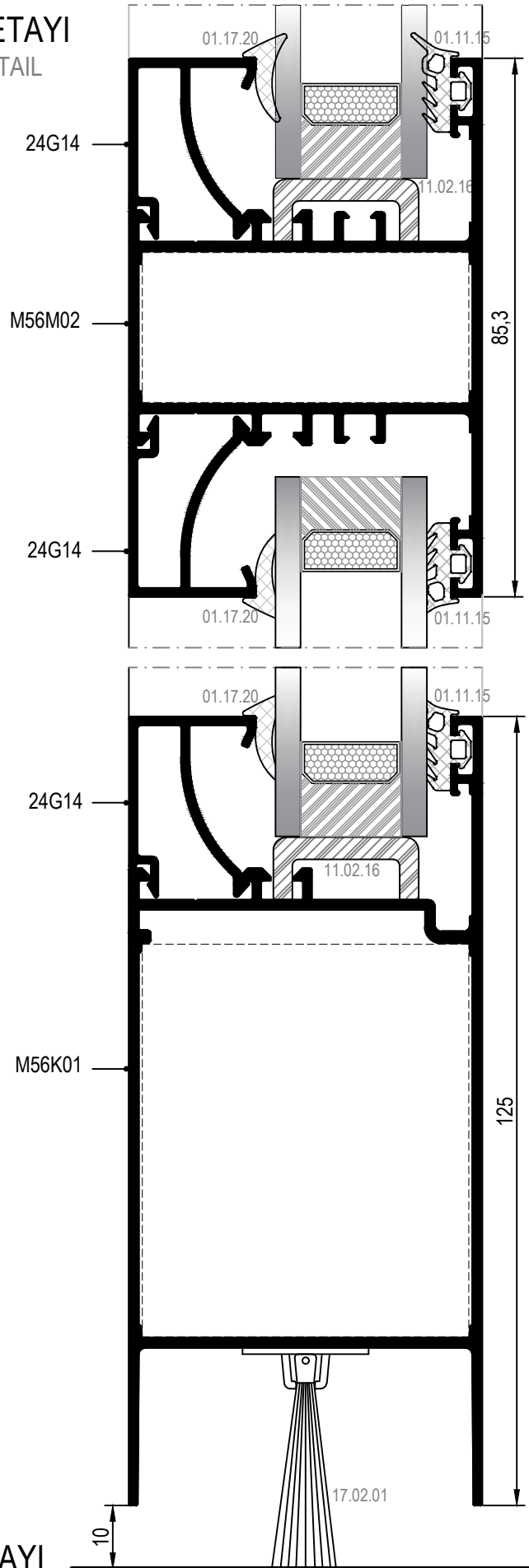

35 DETAYI
DETAIL

DIŐ
(OUTSIDE) ➤











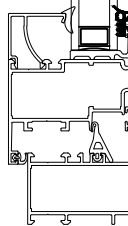

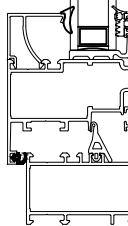

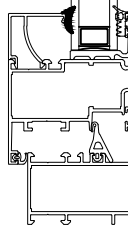
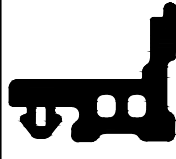
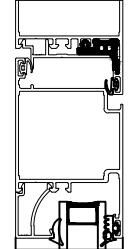

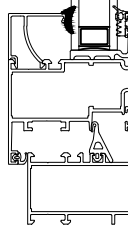
MİMARİ KATALOG
ARCHITECTURAL CATALOGUE

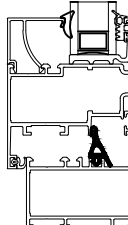

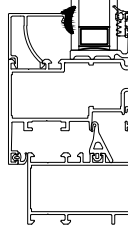
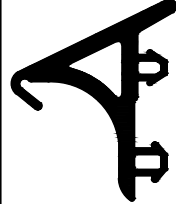
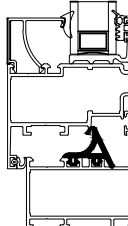
Alüminyum Kapı ve Pencere Sistemleri
Aluminium Door and Window Systems

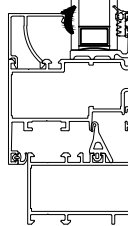
RW56

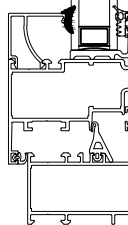
AKSESUARLAR

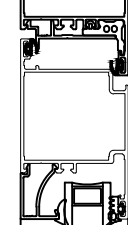
ACCESSORIES

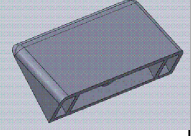
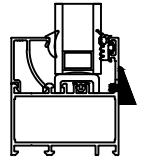
	<p>01.11.15</p> <p>DIŞ CAM FİTİLİ 4 mm OUTSIDE GLAZING GASKET 4 mm</p> <p>Malzeme / Material : EPDM Ağırlık / Weight : 81 gr/m Paket / Package: 185m / 15 kg</p>			<p>01.18.33</p> <p>İÇ BİNİ FİTİLİ ACOUSTICAL GASKET</p> <p>Malzeme / Material : EPDM Ağırlık / Weight : 30 gr/m Paket / Package: 500m / 15 kg</p>	
	<p>01.17.20</p> <p>İÇ CAM FİTİLİ 2,7 mm INSIDE GLAZING GASKET 2,7 mm</p> <p>Malzeme / Material : EPDM Ağırlık / Weight : 52 gr/m Paket / Package: 288m / 15 kg</p>			<p>01.19.35</p> <p>ADAPTÖR FİTİLİ ADAPTER GASKET</p> <p>Malzeme / Material : EPDM Ağırlık / Weight : 193 gr/m Paket / Package: 77m / 15 kg</p>	
	<p>01.17.05</p> <p>İÇ CAM FİTİLİ 4,6 mm INSIDE GLAZING GASKET 4,6 mm</p> <p>Malzeme / Material : EPDM Ağırlık / Weight : 89 gr/m Paket / Package: 168m / 15 kg</p>			<p>01.19.37</p> <p>TOZLUK FİTİLİ CENTRAL GASKET</p> <p>Malzeme / Material : EPDM Ağırlık / Weight : 120 gr/m Paket / Package: 125m / 15 kg</p>	
	<p>01.17.14</p> <p>İÇ CAM FİTİLİ 5 mm INSIDE GLAZING GASKET 5 mm</p> <p>Malzeme / Material : EPDM Ağırlık / Weight : 100 gr/m Paket / Package: 150m / 15 kg</p>			<p>01.19.43</p> <p>TOZLUK FİTİLİ CENTRAL GASKET</p> <p>Malzeme / Material : EPDM Ağırlık / Weight : 180 gr/m Paket / Package: 83m / 15 kg</p>	
	<p>01.17.15</p> <p>İÇ CAM FİTİLİ 6 mm INSIDE GLAZING GASKET 6 mm</p> <p>Malzeme / Material : EPDM Ağırlık / Weight : 118 gr/m Paket / Package: 127m / 15 kg</p>				
	<p>01.17.21</p> <p>İÇ CAM FİTİLİ 6,5 mm INSIDE GLAZING GASKET 6,5 mm</p> <p>Malzeme / Material : EPDM Ağırlık / Weight : 155 gr/m Paket / Package: 96m / 15 kg</p>				
	<p>01.18.32</p> <p>BİNİ FİTİLİ ACOUSTICAL GASKET</p> <p>Malzeme / Material : EPDM Ağırlık / Weight : 35 gr/m Paket / Package: 428m / 15 kg</p>				

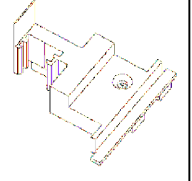
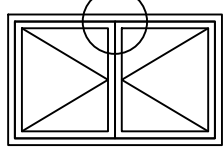
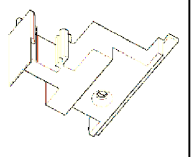
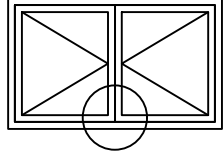
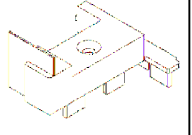
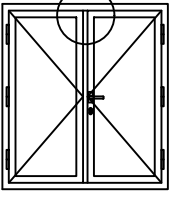
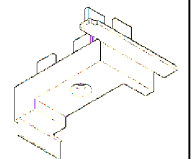
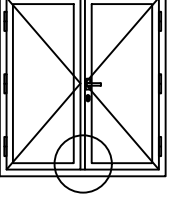
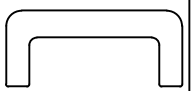
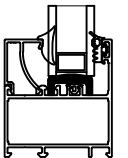
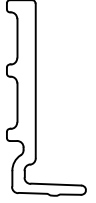
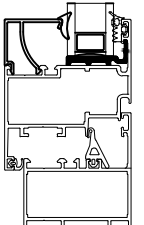
	<p>04.02.07</p> <p>TAHLİYE KAPAĞI DRAINAGE COVER</p> <p>Malzeme / Material : PVC Renk / Colour : Siyah-Beyaz-Gri Black-White-Grey</p>			<p>10.10.01</p> <p>MONTAJ LAMASI (140mm) LAMA FOR ASSEMBLY (140mm)</p>	
	<p>04.06.42</p> <p>ADAPTÖR KAPAĞI (ÜST) ADAPTER CAP (UP)</p> <p>Malzeme / Material : PVC Renk / Colour : Siyah / Black M56 A 04 İÇİN / FOR M56 A 04</p>				
	<p>04.06.43</p> <p>ADAPTÖR KAPAĞI (ALT) ADAPTER CAP (DOWN)</p> <p>Malzeme / Material : PVC Renk / Colour : Siyah / Black M56 A 04 İÇİN / FOR M56 A 04</p>				
	<p>04.06.44</p> <p>ADAPTÖR KAPAĞI (ÜST) ADAPTER CAP (UP)</p> <p>Malzeme / Material : PVC Renk / Colour : Siyah / Black M56DA01&02 İÇİN / FOR M56DA 01& 02</p>				
	<p>04.06.45</p> <p>ADAPTÖR KAPAĞI (ALT) ADAPTER CAP (DOWN)</p> <p>Malzeme / Material : PVC Renk / Colour : Siyah / Black M56DA01&02 İÇİN / FOR M56DA 01& 02</p>				
	<p>11.02.16</p> <p>CAM TAKOZU GLASS SUPPORT</p> <p>Malzeme / Material : PVC Renk / Colour : Siyah / Black</p>				
	<p>11.02.17</p> <p>CAM TAKOZU GLASS SUPPORT</p> <p>Malzeme / Material : PVC Renk / Colour : Siyah / Black</p>				

PENCERE MENTEŞELERİ / WINDOW HINGES



15.01.16

GIESSE PENCERE MENTEŞESİ
GIESSE HINGE FOR WINDOWS

Renk / Colour : Siyah-Beyaz-Gri-Eloksal
Black-White-Grey-Anodised

75 kg için 2 adet, 85 kg için 3 adet kullanılmalıdır. / Should be used 2 for 75 kg,3 for 85 kg.
EN 1935:2002

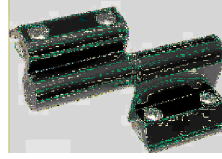

15.01.03

RESCARA PENCERE MENTEŞESİ
RESCARA HINGE FOR WINDOWS

Renk / Colour : Pres-Eloksal
Press-Anodised

75 kg için 2 adet, 85 kg için 3 adet kullanılmalıdır. / Should be used 2 for 75 kg,3 for 85 kg.
EN 1935:2002

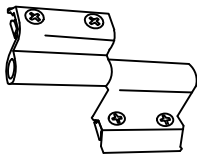

15.01.08

YERLİ PENCERE MENTEŞESİ
LOCAL HINGE FOR WINDOWS

Renk / Colour : Siyah-Beyaz-Gri-Eloksal
Black-White-Grey-Anodised

50 kg için 2 adet kullanılmalıdır. / Should be used 2 for 50 kg.
Max. kanat ölçüsü 900x1300. / Max. vent dimension 900x1300
TS EN 1935

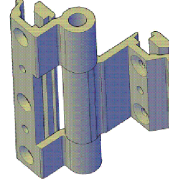

15.01.12

YERLİ PENCERE MENTEŞESİ
LOCAL HINGE FOR WINDOWS

Renk / Colour : Siyah-Beyaz-Gri-Eloksal
Black-White-Grey-Anodised

TS EN 1935



15.01.17

GIESSE GİZLİ PENCERE MENTEŞESİ (SAĞ)
GIESSE HIDDEN HINGE FOR WINDOWS (RIGHT)

Malzeme / Material : Paslanmaz Çelik
Stainless Steel

100 kg için 2 adet kullanılmalıdır. / Should be used 2 for 100 kg.



15.01.18

GIESSE GİZLİ PENCERE MENTEŞESİ (SOL)
GIESSE HIDDEN HINGE FOR WINDOWS (LEFT)

Malzeme / Material : Paslanmaz Çelik
Stainless Steel

100 kg için 2 adet kullanılmalıdır. / Should be used 2 for 100 kg.

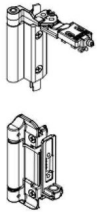

15.01.20

RESCARA PASİF KANAT MENTEŞESİ
RESCARA PASSIVE LEAF HINGE

Renk / Colour : Siyah-Beyaz-Gri-Eloksal
Black-White-Grey-Anodized

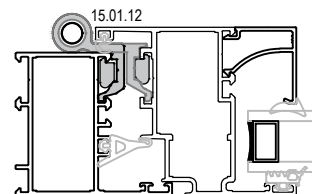
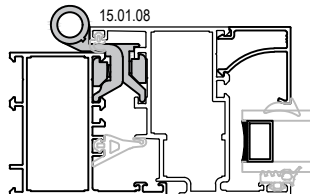
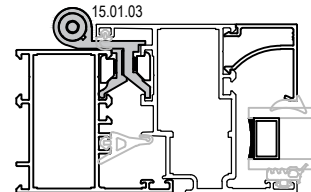
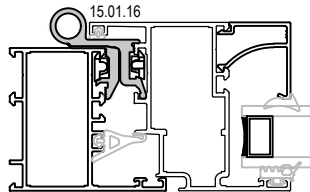

Ölçek/Scale: 1/3

KAPI MENTEŞELERİ / DOOR HINGES

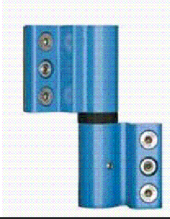

15.02.20

RESCARA KAPI MENTEŞESİ
RESCARA HINGE FOR DOORS

Renk / Colour : Siyah-Beyaz-Gri-Pres-Eloksal
Black-White-Grey-Press-Anodized

120 kg için 2 adet kullanılmalıdır. / Should be used 2 for 120 kg.
TS EN 1935



15.02.09

YERLİ KAPI MENTEŞESİ
LOCAL HINGE FOR DOORS

Renk / Colour : Siyah-Beyaz-Gri-Eloksal
Black-White-Grey-Anodized

85 kg için 3 adet kullanılmalıdır. / Should be used 3 for 85 kg.
Max. kanat ölçüsü 900x2200./ Max. vent dimension 900x2200
TS EN 1935

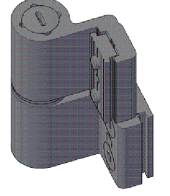

15.02.12

YERLİ KAPI MENTEŞESİ
LOCAL HINGE FOR DOORS

Renk / Colour : Siyah-Beyaz-Gri-Eloksal
Black-White-Grey-Anodized

100 kg için 3 adet kullanılmalıdır. / Should be used 3 for 100 kg.
Max. kanat ölçüsü 900x2300./ Max. vent dimension 900x2300
TS EN 1935

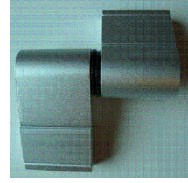

15.02.07

YERLİ KAPI MENTEŞESİ

LOCAL HINGE FOR DOORS
Renk / Colour : Siyah-Beyaz-Gri-Eloksal
Black-White-Grey-Anodized

100 kg için 2 adet kullanılmalıdır. / Should be used 2 for 100 kg.
Max. kanat ölçüsü 900x2200./ Max. vent dimension 900x2200
TS EN 1935



15.02.14

GIESE KAPI MENTEŞESİ
GIESE HINGE FOR DOORS

Renk / Colour : Siyah-Beyaz-Eloksal
Black-White-Anodized

100 kg için 2 adet, 120 kg için 3 adet kullanılmalıdır. / Should be used 2 for 100 kg,3 for 120 kg.
EN 1935

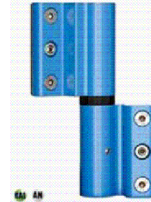

15.02.21

RESCARA KAPI MENTEŞESİ
RESCARA HINGE FOR DOORS

Renk / Colour : Siyah-Beyaz-Gri-Pres-Eloksal
Black-White-Grey-Press-Anodized

160 kg için 2 adet kullanılmalıdır. / Should be used 2 for 160 kg.
TS EN 1935

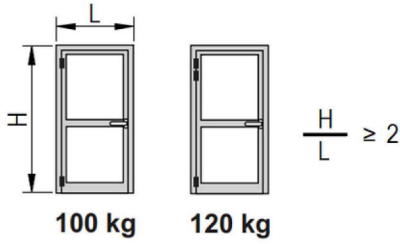

KNT. YÜKSEKLİĞİ / SASH HEIGHT KNT. GENİŞLİĞİ / SASH WIDTH	KANAT AĞIRLIĞI SASH WEIGHT
$\frac{H}{L} = 1.9$	Max (- 10%)
$\frac{H}{L} = 1.8$	Max (- 20%)
= ...	Max (- ...%)
$\frac{H}{L} \leq 1$	UYGULANAMAZ NA

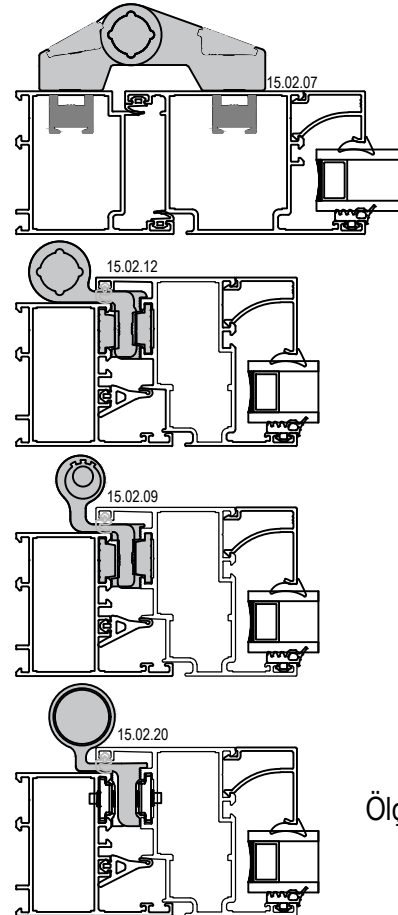

Ölçek/Scale: 1/3

ÇİFT EKSEN MEKANİZMALARI / TILT & TURN MECHANISM

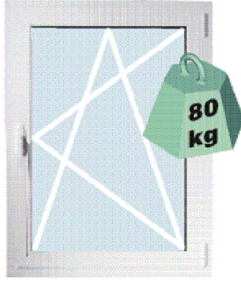

GIESSE FUTURA ÇİFT AÇILIM SETİ 80 kg
GIESSE FUTURA TILT & TURN MECHANISM 80 kg

Renk / Colour : Siyah-Beyaz-Gri
Black-White-Grey

ADET NUMBER	07.06.001 MEKANİZMA MECHANISM	07.06.002 MENTEŞE SETİ HINGE KIT	07.06.003 TİP1 MAKAS TYPE1 ARM	07.06.004 TİP2 MAKAS TYPE2 ARM	07.06.005 KOL HANDLE	07.06.006 İLAVE KİLİTLEME ADDITIONAL LOCKING	07.06.007 İLAVE MAKAS ADDITIONAL ARM
L: 410-569mm H: 600-1200mm	1	1	1	---	1	---	---
L: 410-569mm H: 1201-2500mm	1	1	1	---	1	1	---
L: 570-1000mm H: 600-1200mm	1	1	---	1	1	---	---
L: 570-1000mm H: 1201-2500mm	1	1	---	1	1	1	---
L: 1001-1700mm H: 600-1200mm	1	1	---	1	1	1	1
L: 1001-1700mm H: 1201-2500mm	1	1	---	1	1	2	1



GIESSE FUTURA ÇİFT AÇILIM SETİ 130 kg
GIESSE FUTURA TILT & TURN MECHANISM 130 kg

Renk / Colour : Siyah-Beyaz-Gri
Black-White-Silver

ADET NUMBER	07.06.001 MEKANİZMA MECHANISM	07.06.016 MENTEŞE SETİ HINGE KIT	07.06.013 TİP1 MAKAS TYPE1 ARM	07.06.014 TİP2 MAKAS TYPE2 ARM	07.06.005 KOL HANDLE	07.06.006 İLAVE KİLİTLEME ADDITIONAL LOCKING	07.06.007 İLAVE MAKAS ADDITIONAL ARM
L: 410-700mm H: 600-1200mm	1	1	1	---	1	---	---
L: 410-700mm H: 1201-3000mm	1	1	1	---	1	1	---
L: 701-1000mm H: 600-1200mm	1	1	---	1	1	---	---
L: 701-1000mm H: 1201-3000mm	1	1	---	1	1	1	---
L: 1001-1800mm H: 600-1200mm	1	1	---	1	1	1	1
L: 1001-1800mm H: 1201-3000mm	1	1	---	1	1	2	1

ÇİFT EKSEN MEKANİZMALARI / TILT & TURN MECHANISM

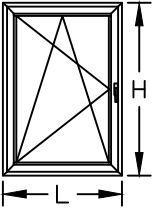
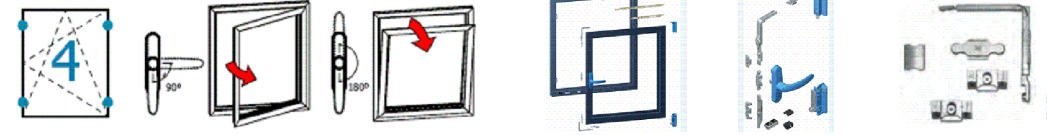
	RESCARA ÇİFT AÇILIM SETİ 130 kg RESCARA TILT & TURN MECHANISM 130 kg Renk / Colour : Siyah-Beyaz-Gri Black-White-Grey					
						
KANAT GENİŞLİĞİ SASH WIDTH L (mt)	KANAT YÜKSEKLİĞİ SASH HEIGHT H (mt)	KANAT AĞIRLIĞI SASH WEIGHT KG	MEKANİZMA MECHANISM	MAKAS ARM	İLAVE KİLİTLEME ADDITIONAL LOCKING	İLAVE MAKAS ADDITIONAL ARM
563-1000 mm	600-1200 mm	130 kg	07.06.79	07.06.80	—	—
563-1000 mm	1200-2500 mm	130 kg	07.06.79	07.06.80	07.06.76	—
1000-1700 mm	600-1200 mm	130 kg	07.06.79	07.06.80	07.06.76	07.06.77
1000-1700 mm	1200-2500 mm	130 kg	07.06.79	07.06.80	07.06.76 (2 ADET)	07.06.77

ÇİFT EKSEN MEKANİZMALARI / TILT & TURN MECHANISM

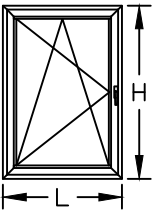
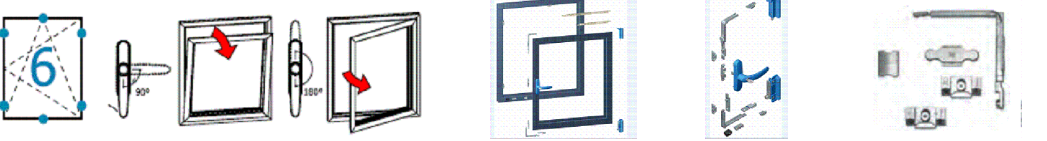
	RESCARA AKILLI ÇİFT AÇILIM SETİ 130 kg / KOL ANAHTARLIDIR. RESCARA TBT TILT & TURN MECHANISM 130 kg / HANDLE WITH KEYLOCK Renk / Colour : Siyah-Beyaz-Gri Black-White-Grey					
						
KANAT GENİŞLİĞİ SASH WIDTH L (mt)	KANAT YÜKSEKLİĞİ SASH HEIGHT H (mt)	KANAT AĞIRLIĞI SASH WEIGHT KG	MEKANİZMA MECHANISM	MAKAS ARM	İLAVE KİLİTLEME ADDITIONAL LOCKING	İLAVE MAKAS ADDITIONAL ARM
563-1000 mm	600-1200 mm	130 kg	07.06.74 (TBT)	07.06.75 (TBT)	—	—
563-1000 mm	1200-2500 mm	130 kg	07.06.74 (TBT)	07.06.75 (TBT)	07.06.76	—
1000-1700 mm	600-1200 mm	130 kg	07.06.74 (TBT)	07.06.75 (TBT)	—	07.06.77
1000-1700 mm	1200-2500 mm	130 kg	07.06.74 (TBT)	07.06.75 (TBT)	07.06.76	07.06.77

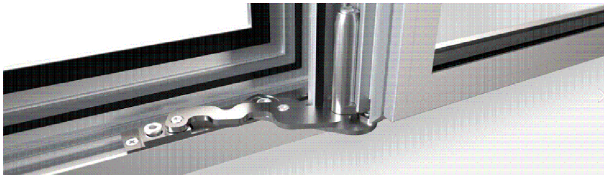

GIESSE GİZLİ MENTEŞE ÇİFT AÇILIM SETİ 100 kg
GIESSE HIDDEN HINGE TILT & TURN MECHANISM 100 kg

Renk / Colour : Siyah-Beyaz-Gri
Black-White-Grey

	ADET NUMBER	07.06.011 TİP2 MAKAS (SAĞ) TYPE2 ARM	07.06.012 TİP2 MAKAS (SOL) TYPE2 ARM	07.06.005 KOL HANDLE	07.06.001 MEKANİZMA MECHANISM	07.06.010 İLAVE KİLİTLEME ADDITIONAL LOCKING	07.06.007 İLAVE MAKAS ADDITIONAL ARM
SAĞ RIGHT	L: 600-1000mm H: 600-1200mm	1	---	1	1	---	---
	L: 600-1000mm H: 1201-2500mm	1	---	1	1	1	---
	L: 1001-1500mm H: 600-1200mm	1	---	1	1	1	1
	L: 1001-1500mm H: 1201-2500mm	1	---	1	1	2	1
SOL LEFT	L: 600-1000mm H: 600-1200mm	---	1	1	1	---	---
	L: 600-1000mm H: 1201-2500mm	---	1	1	1	1	---
	L: 1001-1500mm H: 600-1200mm	---	1	1	1	1	1
	L: 1001-1500mm H: 1201-2500mm	---	1	1	1	2	1

PENCERE KOLLARI / WINDOW HANDLES

<p>07.05.25 GIESSE İSPANYOLET KOL (ÇİFT DİLLİ) GIESSE HANDLE FOR WINDOWS (DOUBLE RAIL) Renk / Colour : Siyah-Beyaz-Gri Black-White-Grey</p> <p>UNI CEI EN ISO / IEC 17050</p>	<p>07.05.33 GIESSE ANAHTARLI İSPANYOLET KOL (ÇİFT DİLLİ) GIESSE KEY HANDLE FOR WINDOWS (DOUBLE RAIL) Renk / Colour : Siyah-Beyaz-Gri Black-White-Grey</p>
<p>07.25.01 GIESSE TIJ BAĞLANTI PARÇASI GIESSE CONNECTION ROD Renk / Colour : Siyah / Black Malzeme / Material : Polyamid / Polyamide</p> <p>07.05.25 , 07.05.33 ve 07.05.34 Kol için For Handle 07.05.25 , 07.05.33 and 07.05.34</p>	<p>07.05.34 GIESSE SÖKÜLEBİLİR KOL GÖVDESİ (ÇİFT DİLLİ) GIESSE REMOVABLE HANDLE BODY (DOUBLE RAIL) Renk / Colour : Siyah-Beyaz-Gri Black-White-Grey</p>
<p>07.05.29 RESCARA GLOBAL ANAHTARLI PENCERE KOLU (TEK DİLLİ) RESCARA GLOBAL KEY HANDLE FOR WINDOWS (SINGLE RAIL) Renk / Colour : Siyah-Beyaz-Gri Black-White-Grey</p> <p>EN 1670</p>	<p>07.05.35 GIESSE SÖKÜLEBİLİR KOL GIESSE REMOVABLE HANDLE Renk / Colour : Siyah Black</p>
<p>07.13.07 RESCARA KOL BAĞLANTI PARÇASI RESCARA CONNECTION PART FOR HANDLE Malzeme / Material : Zamak / Zamak</p> <p>07.05.28, 07.05.29 Kol için / For Handle 07.05.28, 07.05.29</p>	<p>07.05.30 RESCARA GLOBAL SÖKÜLEBİLİR KOL GÖVDESİ (ÇİFT DİLLİ) RESCARA GLOBAL REMOVABLE HANDLE BODY (DOUBLE RAIL) Renk / Colour : Siyah-Beyaz-Gri Black-White-Grey</p> <p>EN 1670</p>
<p>07.05.28 RESCARA GLOBAL PENCERE KOLU (TEK DİLLİ) RESCARA GLOBAL HANDLE FOR WINDOWS (SINGLE RAIL) Renk / Colour : Siyah-Beyaz-Gri Black-White-Grey</p> <p>EN 1670</p>	<p>07.05.31 RESCARA SÖKÜLEBİLİR KOL RESCARA REMOVABLE HANDLE Renk / Colour : Siyah / Black</p> <p>EN 1670</p>
<p>07.05.32 RESCARA GLOBAL PENCERE KOLU (ÇİFT DİLLİ) RESCARA GLOBAL HANDLE FOR WINDOWS (DOUBLE RAIL) Renk / Colour : Siyah-Beyaz-Gri Black-White-Grey</p> <p>EN 1670, 13126-8</p>	<p>07.13.08 RESCARA KOL BAĞLANTI PARÇASI RESCARA CONNECTION PART FOR HANDLE Renk / Colour : Siyah / Black Malzeme / Material : PVC</p> <p>07.05.30, 07.05.32 Kol için / For Handle 07.05.30, 07.05.32</p>

İSPANYOLET KİLİTLEME PARÇALARI / LOCKING KITS



07.13.03

PİM
LOCK PIN

Malzeme / Material : Zamak / Zamak



07.13.06

GIESSE PİM
GIESSE ADJUSTABLE LOCKING PAWL

Malzeme / Material : Zamak / Zamak

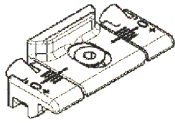

07.09.07

GIESSE AYARLI PİM KARŞILIĞI
GIESSE ADJUSTABLE SINGLE STRIKER

Malzeme / Material : Zamak / Zamak

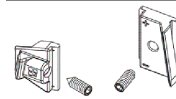

07.09.08

GIESSE ARKA KİLİTLEME
GIESSE BURGLAR BOLT

Malzeme / Material : Zamak / Zamak

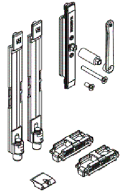

18.07.02

GIESSE PASİF KANAT SÜRGÜ SETİ
GIESSE BOLT FOR PASSIVE LEAF

Malzeme / Material : Zamak ve polyamid
Zamak and polyamide



07.09.11

RESCARA SABİT KARŞILIK
RESCARA FIXED STRIKER

Malzeme / Material : Zamak / Zamak

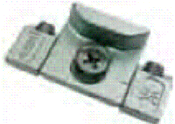

07.09.12

RESCARA AYARLI KARŞILIK
RESCARA ADJUSTABLE STRIKER

Malzeme / Material : Zamak / Zamak



07.09.13

RESCARA ARKA KİLİTLEME
RESCARA BURGLAR BOLT

Malzeme / Material : Zamak / Zamak



07.21.03

RESCARA KÖŞE DÖNME
RESCARA CORNER DRIVE

Malzeme / Material : Zamak / Zamak



07.21.02

GIESSE KÖŞE DÖNME
GIESSE CORNER DRIVE





Malzeme / Material : Zamak / Zamak





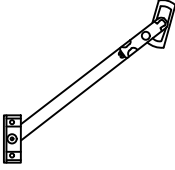
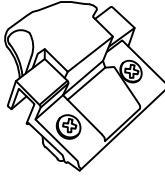
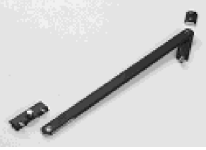

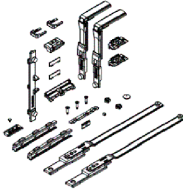

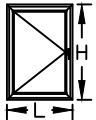

07.06.78

RESCARA MICROVENTİLASYON
RESCARA MICROVENTILATION

Malzeme / Material : Zamak / Zamak

 <p>07.07.02 VASİSTAS MAKAS ARM FOR BOTTOM-HUNG WINDOWS Renk / Colour : Siyah-Beyaz-Gri Black-White-Grey</p>	 <p>07.08.01 RESCARA VASİSTAS MANDAL RESCARA DEVICE FOR CLOSING BOTTOM-HUNG WINDOWS Renk / Colour : Siyah-Beyaz-Gri Black-White-Grey</p>
 <p>07.07.08 SINIRLAYICI MAKAS LIMITER Malzeme / Material : Gümüş- Paslanmaz Çelik Silver - Stainless Steel</p>	 <p>07.07.09 GIESSE VASİSTAS MAKAS GIESSE ARM FOR BOTTOM-HUNG WINDOWS Renk / Colour : Siyah-Beyaz-Gri Black-White-Grey</p>
 <p>07.07.11 GIESSE VASİSTAS PENCERE SETİ GIESSE BOTTOM HUNG WINDOW SET Kol ve menteşe sete dahil değildir. Handle and hinge is not included in the set</p>	 <p>11.02.34 RESCARA KANAT DESTEK TAKOZU RESCARA VENT SUPPORT PIECE Malzeme / Material : PVC Renk / Colour : Siyah/Black</p>

ÇİFT DİLLİ KOL VE KİLİTLEME SETİ SEÇİM TABLOSU DOUBLE RAILED HANDLE AND LOCKING KIT TABLE						
			TEMEL SET MAIN SET		İLAVE ÜRÜNLER ADDITIONAL PRODUCTS	
KOD CODE	AÇIKLAMA DESCRIPTION	ÜRÜN RESMİ PRODUCT IMAGE	H<1200mm L<1000mm	1200mm < H < 2700 mm	1000mm < L < 1400 mm	
07.05.25	GIESSE ÇİFT DİLLİ KOL GIESSE DOUBLE RAIL HANDLE		1			
07.25.01	GIESSE KOL BAĞLANTISI GIESSE ROD CONNECTION PIECES		1			
07.13.06	GIESSE AYARLI PİM GIESSE ADJUSTABLE LOCKING PAWL		2	2	2	
07.09.11	RESCARA SABİT KARŞILIK RESCARA FIXED STRIKER		2	2	2	
07.09.07	GIESSE AYARLI PİM KARŞILIĞI GIESSE ADJUSTABLE SINGLE STRIKER				2	
07.21.02	GIESSE KÖŞE DÖNME GIESSE CORNER DRIVE				2	
11.02.34	RESCARA KANAT DESTEK TAKOZU RESCARA VENT SUPPORT PIECE		1			

***Giesse kol ve kilitleme aksesuarları 25 I 07 tij profili ile kullanılmalıdır.
Giesse handle and locking accessories should be used with 25 I 07 rod profile

TEK DİLLİ KOL VE KİLİTLEME SETİ SEÇİM TABLOSU

SINGLE RAILED HANDLE AND LOCKING KIT TABLE

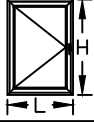

KOD CODE	AÇIKLAMA DESCRIPTION	ÜRÜN RESMİ PRODUCT IMAGE	TEMEL SET MAIN SET	İLAVE ÜRÜNLER ADDITIONAL PRODUCTS	
			H<1200mm L<1000mm	1200mm < H < 2700 mm	1000mm < L < 1400 mm
07.05.28 07.05.29	RESCARA TEK DİLLİ KOL GIESSE DOUBLE RAIL HANDLE		1		
07.13.07	RESCARA KOL BAĞLANTI PARÇASI RESCARA CONNECTION PART FOR HANDLE		1		
07.13.06	GIESSE AYARLI PİM GIESSE ADJUSTABLE LOCKING PAWL		2	2	2
07.09.11	RESCARA SABİT KARŞILIK RESCARA FIXED STRIKER		2	2	2
07.09.12	RESCARA AYARLI KARŞILIK RESCARA ADJUSTABLE STRIKER				2
07.21.03	RESCARA KÖŞE DÖNME RESCARA CORNER DRIVE				2
11.02.34	RESCARA KANAT DESTEK TAKOZU RESCARA VENT SUPPORT PIECE		1		

ÇİFT/TEK AÇILIM PASİF KANAT AKSESUAR SEÇİM TABLOSU

SECONDARY SASH LOCKING KIT TABLE

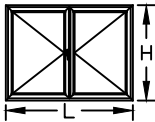

KOD CODE	AÇIKLAMA DESCRIPTION	ÜRÜN RESMİ PRODUCT IMAGE	TEMEL SET MAIN SET	İLAVE ÜRÜNLER ADDITIONAL PRODUCTS	
			H<1200mm L<1000mm	1200mm < H < 2700 mm	1000mm < L < 1400 mm
18.07.02	GIESSE SÜRGÜ SETİ GIESSE BOLT FOR LEAF		1		
07.21.02	GIESSE KÖŞE DÖNME PARÇASI GIESSE CORNER DRIVE				2
07.09.07	GIESSE AYARLI PİM KARŞILIĞI GIESSE ADJUSTABLE SINGLE STRIKER				2
07.09.08	GIESSE ARKA KİLİTLEME GIESSE BURGLAR BOLT			1	

***Giesse kol ve kilitleme aksesuarları 25 I 07 tij profili ile kullanılmalıdır.

Giesse handle and locking accessories should be used with 25 I 07 rod profile

KAPI KOLLARI / DOOR HANDLES



07.14.06

GIESSE KAPI KOLU
GIESSE DOOR HANDLE

Renk / Colour : Siyah-Beyaz-Gri
Black-White-Grey



07.14.07

RESCARA GLOBAL KAPI KOLU
RESCARA GLOBAL DOOR HANDLE

Renk / Colour : Siyah-Beyaz-Gri
Black-White-Grey



07.14.08

RESCARA MULETA KAPI KOLU
RESCARA GLOBAL DOOR HANDLE

Renk / Colour : Siyah-Beyaz-Gri
Black-White-Grey

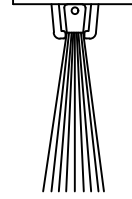

17.02.01

KAPI ALTI FIRÇASI
BRUSH FOR DOORS

Malzeme / Material : Polipropilen /Polypropylene

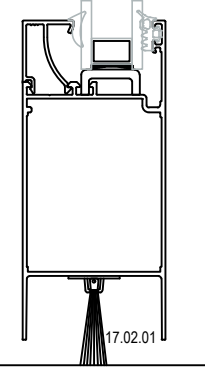

Ölçek/Scale: 1/3

KAPI KOLLARI / DOOR HANDLES



07.17.19

AKBANK KAPI KOLU
DOOR HANDLE

Renk / Colour : Siyah-Beyaz-Gri-Eloksal
Black-White-Grey-Anodised

Ölçüler / Dimensions: H:200 cm

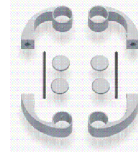

07.13.10

AKBANK KOL APARATI
DOOR HANDLE

Renk / Colour : Siyah-Beyaz-Gri-Eloksal
Black-White-Grey-Anodised

KIVRIK KOL DOOR HANDLE		Renk / Colour : Siyah-Beyaz-Eloksal Black-White-Anodised		
KOD CODE	Ø (mm)	A (mm)	B (mm)	
07.17.10	25	200	130	
07.17.11	25	300	130	
07.17.02	25	400	130	
07.17.27	25	500	160	

V KOL DOOR HANDLE		Renk / Colour : Siyah-Beyaz-Eloksal Black-White-Anodised		
KOD CODE	Ø (mm)	A (mm)	B (mm)	C (mm)
07.17.06	25	200	130	80
07.17.29	25	250	130	80
07.17.30	25	300	130	80
07.17.31	30	400	160	100

U KOL DOOR HANDLE		Renk / Colour : Siyah-Beyaz-Eloksal Black-White-Anodised		
KOD CODE	Ø (mm)	A (mm)	B (mm)	
07.17.08	25	200	80	
07.17.35	25	300	80	
07.17.36	30	400	100	

YARIM AY KOL DOOR HANDLE		Renk / Colour : Siyah-Beyaz-Eloksal Black-White-Anodised		
KOD CODE	Ø (mm)	A (mm)	B (mm)	C (mm)
07.17.32	25	200	130	80
07.17.20	25	300	130	80
07.17.33	30	350	160	100

YAY KOL DOOR HANDLE		Renk / Colour : Siyah-Beyaz-Eloksal Black-White-Anodised		
KOD CODE	Ø (mm)	A (mm)	B (mm)	
07.17.37	80	400	350	
07.17.22	80	500	450	
07.17.38	80	600	550	
07.17.39	80	700	650	
07.17.40	80	800	750	

BASTON KOL DOOR HANDLE		Renk / Colour : Siyah-Beyaz-Eloksal Black-White-Anodised		
KOD CODE	Ø (mm)	A (mm)	B (mm)	C (mm)
07.17.23	25	900	180	80
07.17.34	25	1000	180	80

KAPI KİLİTLERİ / DOOR LOCKS

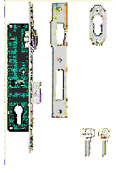

18.01.01

MAKARALI KİLİT
MORTISE LOCK (WITH ROLLER)



18.01.02

DİLLİ KİLİT
MORTISE LOCK

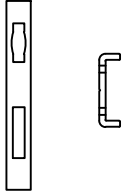

18.02.23

MAKARALI KİLİT KARŞILIĞI
FOREND FOR MORTISE LOCK

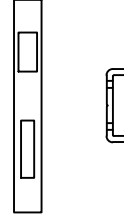

18.02.22

DİLLİ KİLİT KARŞILIĞI
FOREND FOR ROLLER LOCK

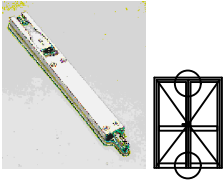

18.03.01

KAPI SÜRGÜSÜ (UZUN)
BOLT FOR DOORS (LONG)

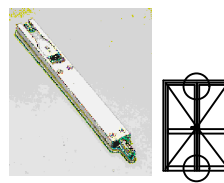

18.03.06

KAPI SÜRGÜSÜ (KISA)
BOLT FOR DOORS (SHORT)

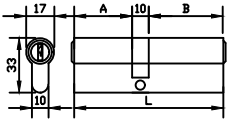

18.04.11

BAREL
CYLINDER

Malzeme / Material : Krom-Nikel / Chrome-Nickel

A	B	L
26	40	76



18.05.02

BAREL AYNASI
CYLINDER COVER

Renk / Colour : Siyah-Beyaz-Grey
Black-White-Grey

**İÇE AÇILIM HEMYÜZ DETAY İÇİN
**INWARD OPENING FLUSH DOOR DETAIL

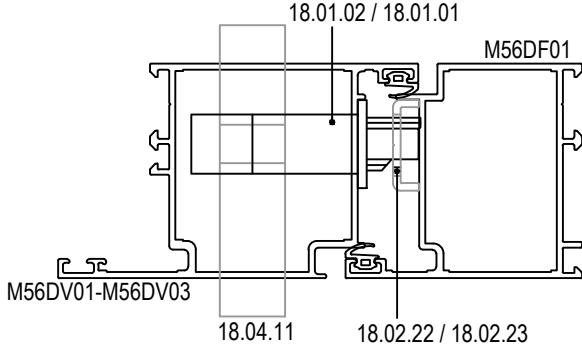

**İÇE AÇILIM HEMYÜZ ORTA BİRLEŞİM DETAYI İÇİN (M56 DA 01)
**INWARD OPENING DOOR DETAIL (M56 DA 01)

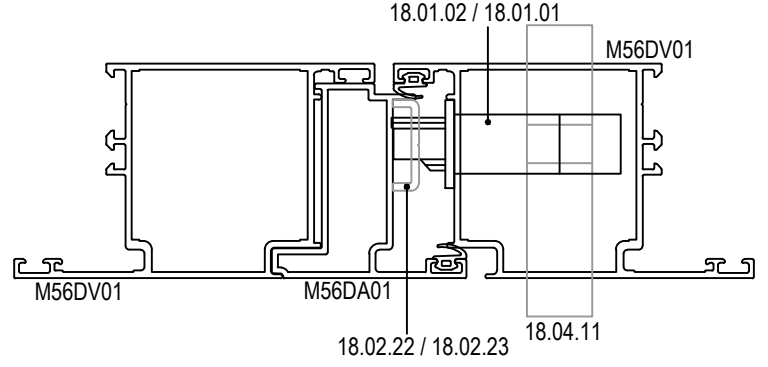

**DIŞA AÇILIM HEMYÜZ DETAY İÇİN
**OUTWARD OPENING FLUSH DOOR DETAIL

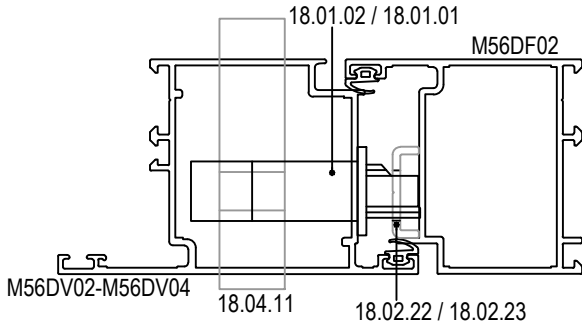

**DIŞA AÇILIM HEMYÜZ ORTA BİRLEŞİM DETAYI İÇİN (M56 DA 02)
**OUTWARD OPENING FLUSH DOOR ADAPTER DETAIL (M56 DA 02)

