

MİMARİ KATALOG
ARCHITECTURAL CATALOGUE

Alüminyum Konvansiyonel Sistemler
Aluminium Conventional Systems

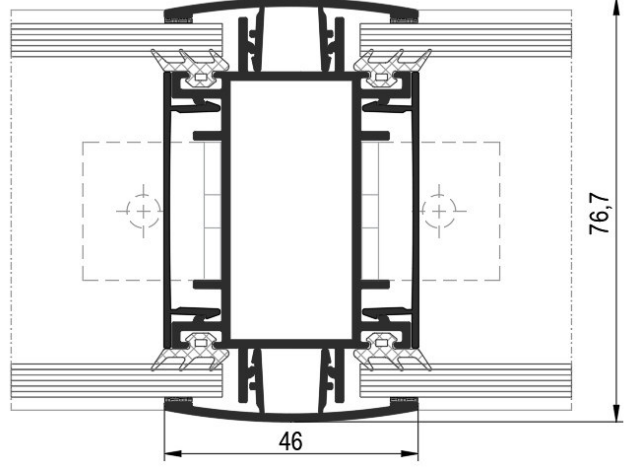

RO73



TEKNİK ÖZELLİKLERİ / TECHNICAL PROPERTIES

PROFİL ET KALINLIĞI / PROFILE WALL THICKNESS	1,5 mm
KASA DERİNLİĞİ / FRAME DEPTH	70 mm

KULLANIM SEÇENEKLERİ / APPLICATION ALTERNATIVES

OFİS SİSTEMİ / OFFICE SYSTEM

MİMARİ KATALOG
ARCHITECTURAL CATALOGUE

Alüminyum Konvansiyonel Sistemler
Aluminium Conventional Systems



R073

PROFİLLER

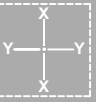
PROFILES

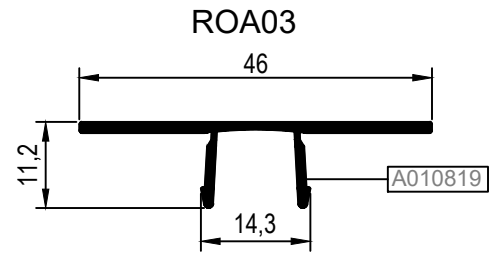
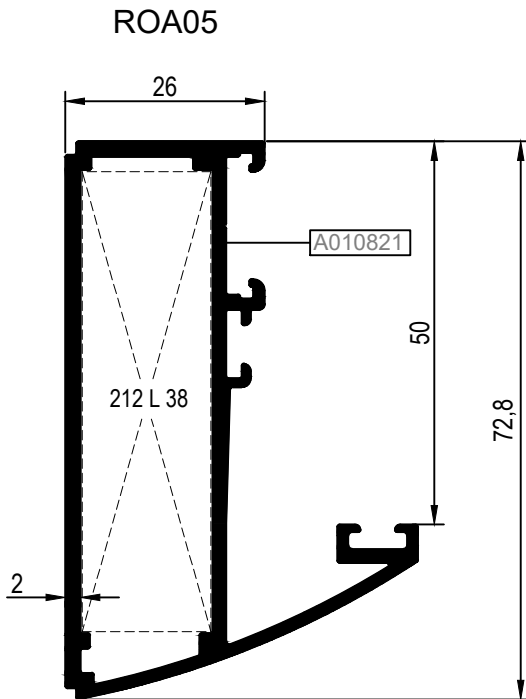
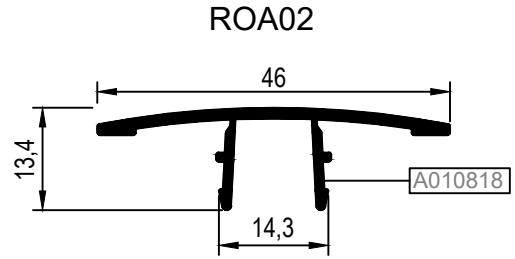
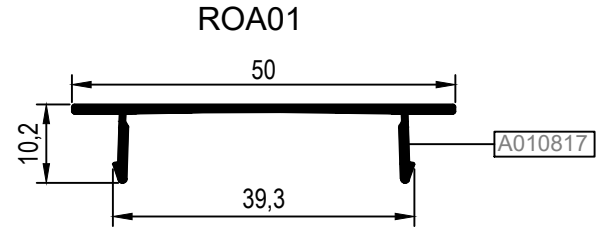
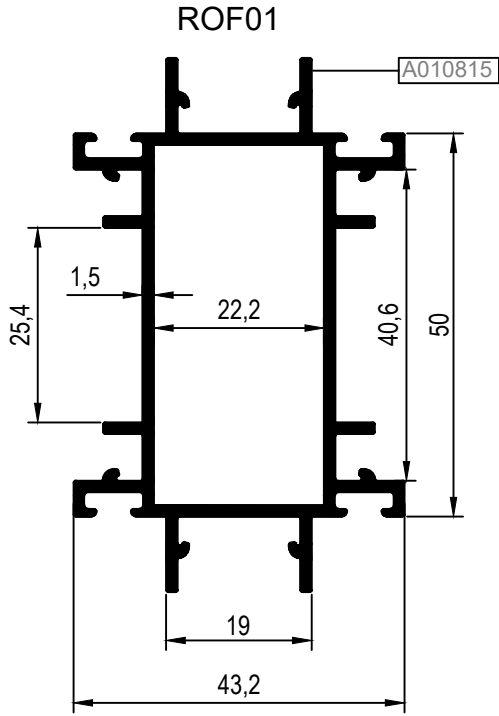
KOD / CODE	AĞIRLIK (kg/m) / WEIGHT	Jxx cm4	Jyy cm4	L m	
ROF01	1,110	6,599	18,194	6	
ROA01	0,209	----	----	6	
ROA02	0,271	----	----	6	
ROA03	0,234	----	----	6	
ROA05	1,214	----	----	6	



Nr	 L m	KESİM ÖLÇÜSÜ CUTTING SIZE	 AKS. KODU ACS. CODE	
ROA05	A010821	25L38 (A002074)	59,8 mm	212 L 38

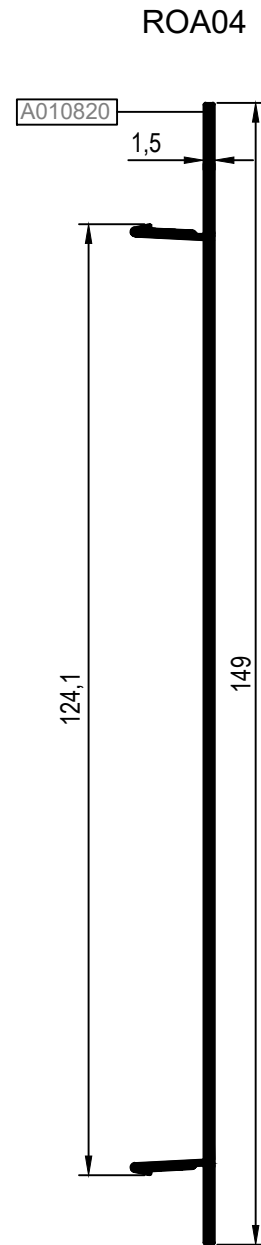
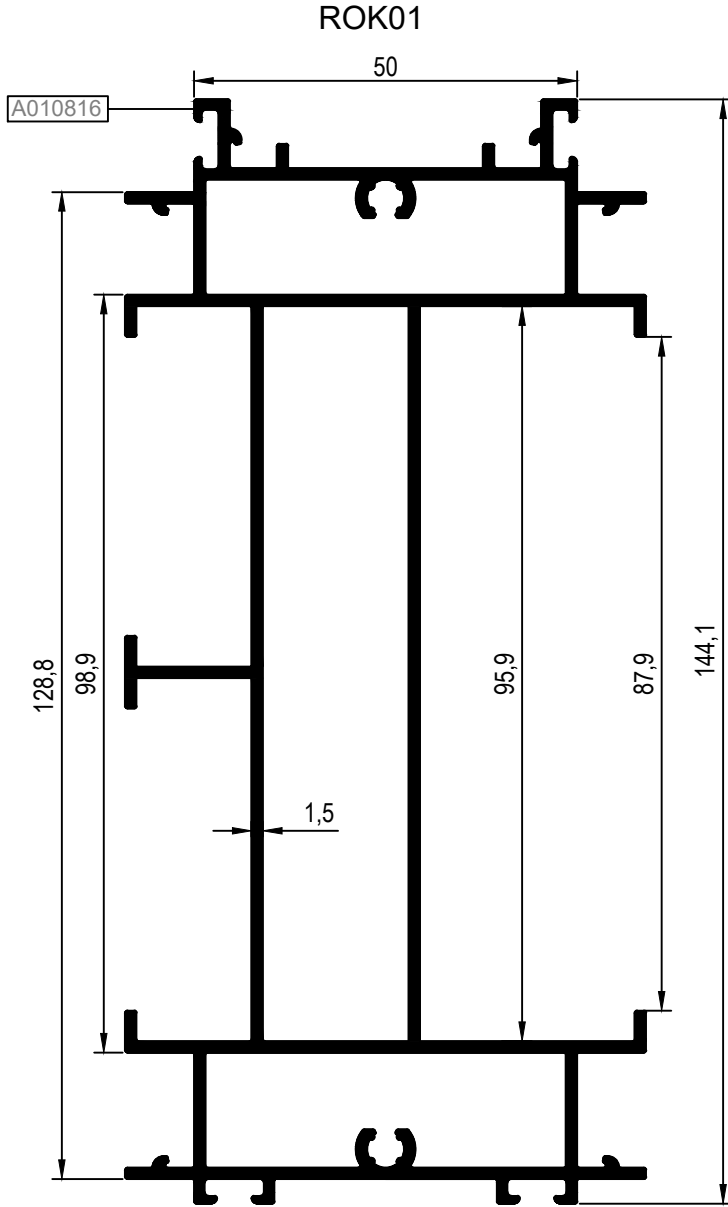

KOD / CODE	AĞIRLIK (kg/m) / WEIGHT	Jxx cm4	Jyy cm4	L m	
ROK01	2,638	----	----	6	
ROA04	0,650	----	----	6	



TAKOZLAR (CLEATS)

PROFİL KODU (PROFILE CODE)	25L38			
FABRİKA KODU (FACTORY CODE)	A002074			
AĞIRLIK (WEIGHT)	4,856 kg/m			
ÇİZİM (DRAWING)				

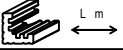
KÖŞE TAKOZLARI (CORNER CLEATS)

Nr			KESİM ÖLÇÜSÜ CUTTING SIZE	 AKS. KODU ACS. CODE
ROA05	A010821	25L38 (A002074)	59,8 mm	212 L 38

MİMARİ KATALOG
ARCHITECTURAL CATALOGUE

Alüminyum Konvansiyonel Sistemler
Aluminium Conventional Systems

RO73

DETAYLAR

DETAILS

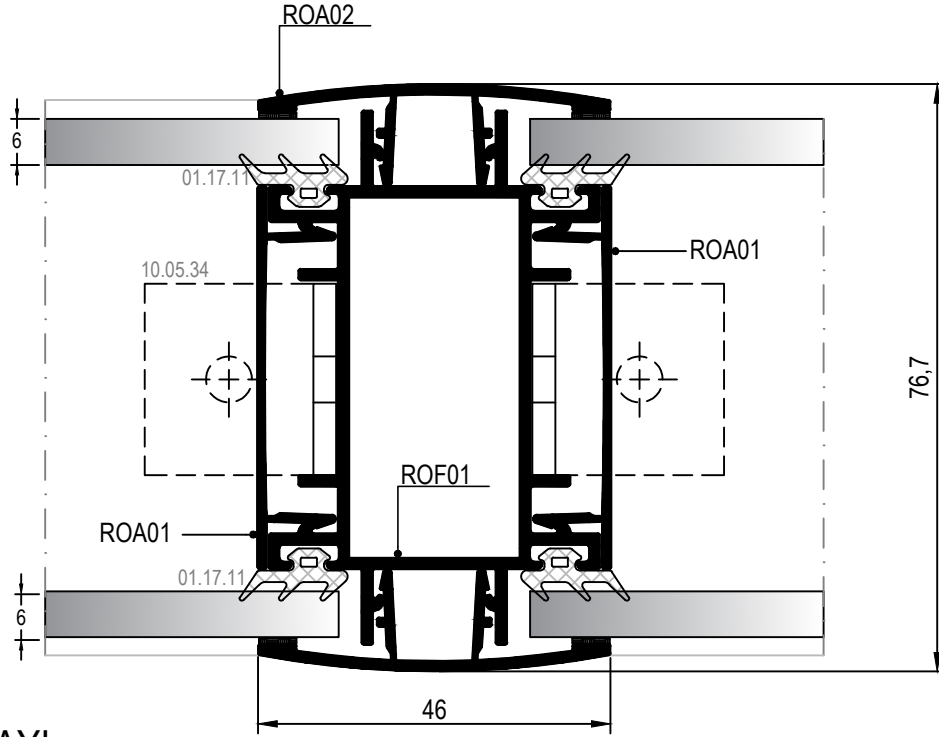
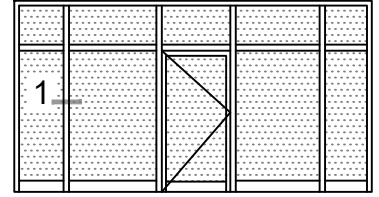

① DETAYI
DETAIL

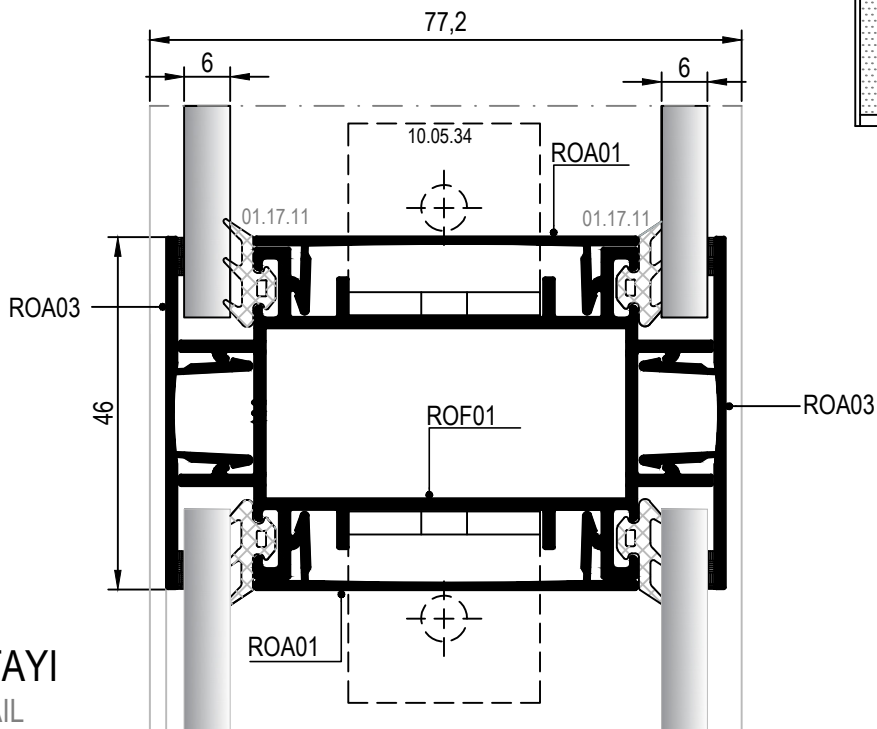
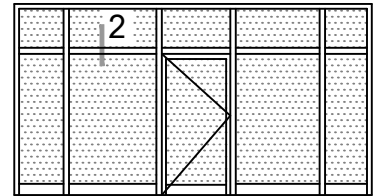

② DETAYI
DETAIL

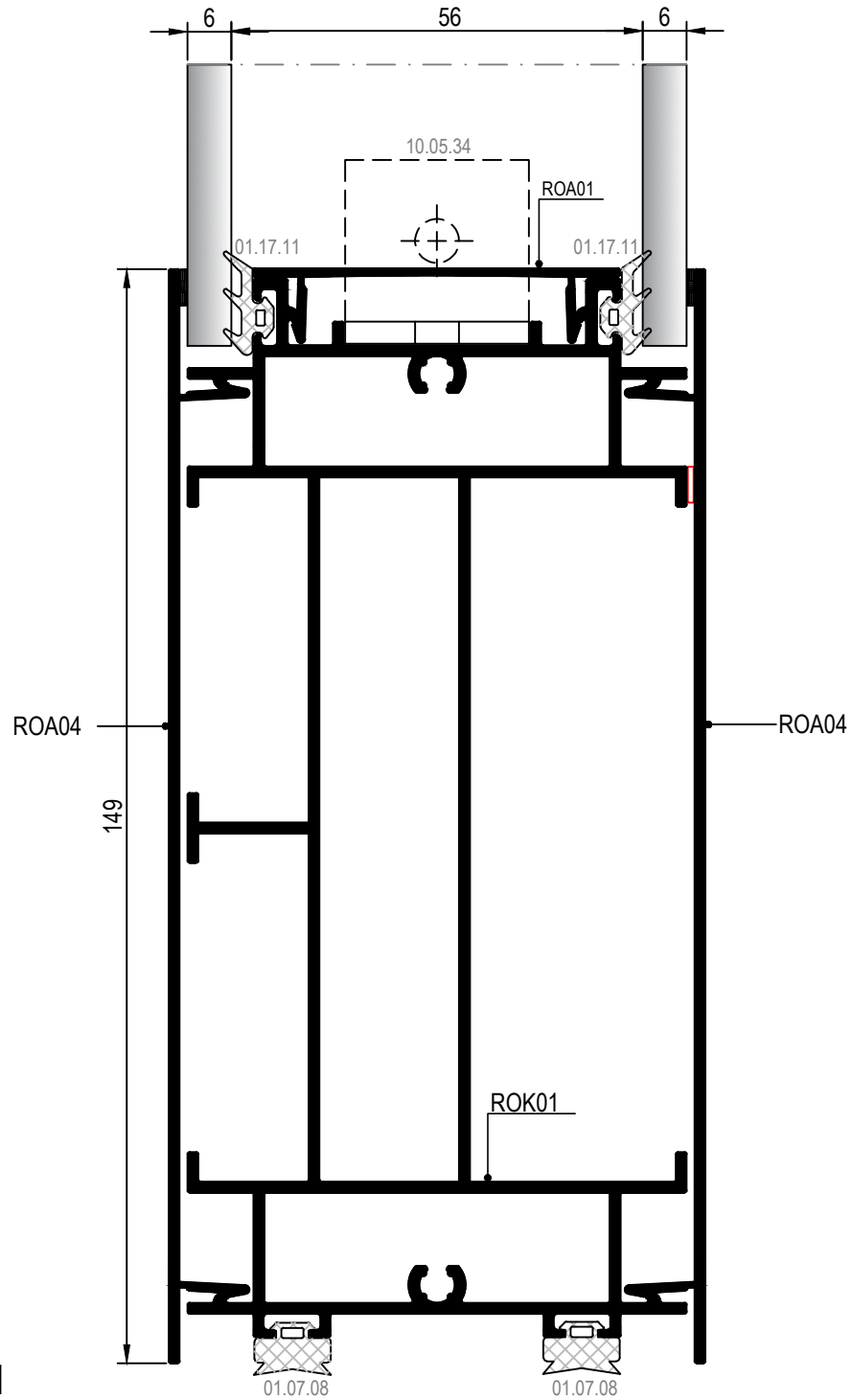
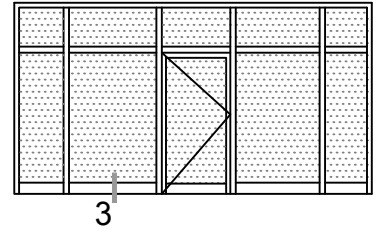

③ DETAYI
DETAIL

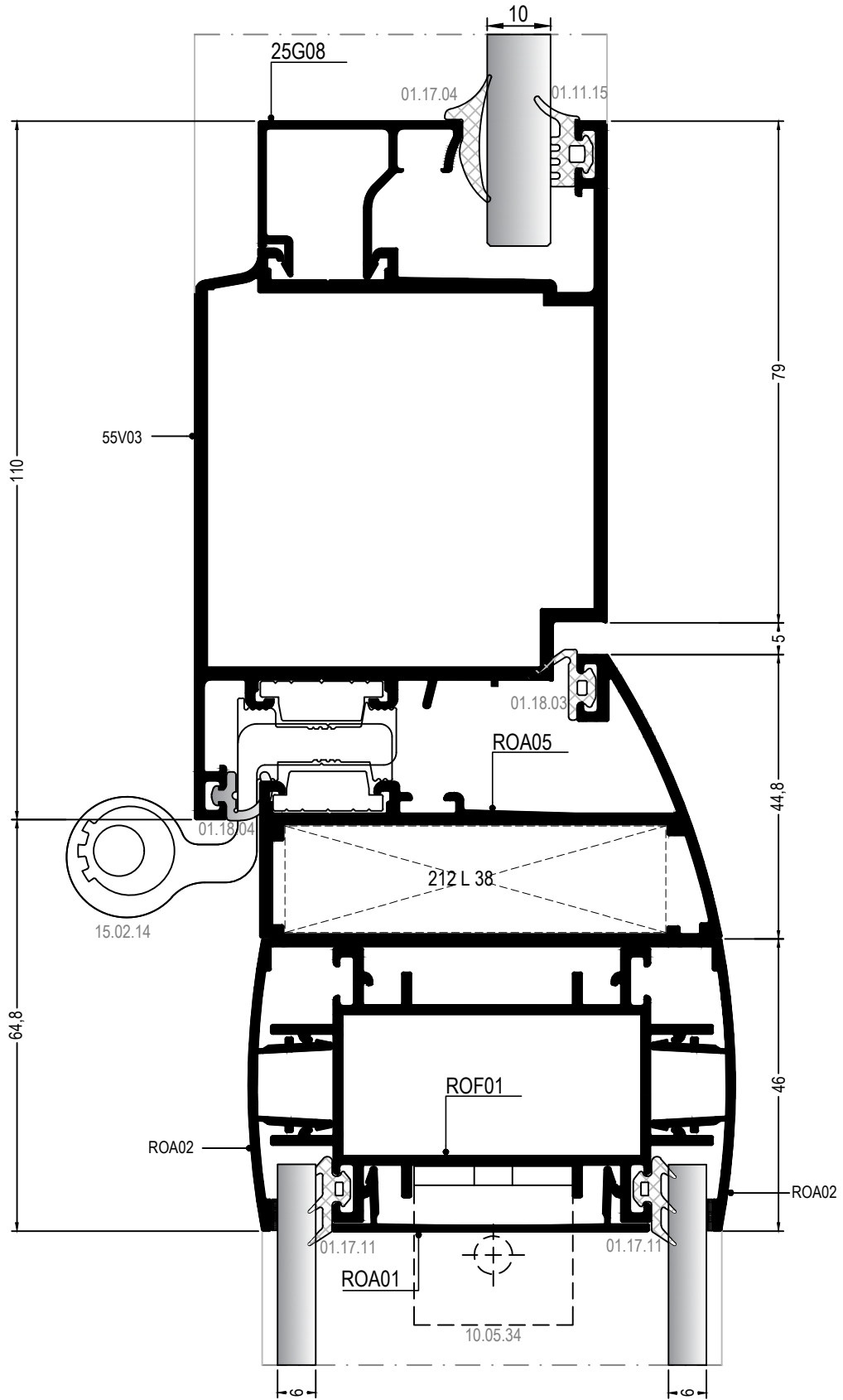
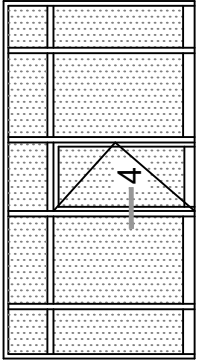

④ DETAYI
DETAIL







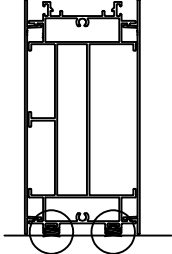

MİMARİ KATALOG
ARCHITECTURAL CATALOGUE

Alüminyum Konvansiyonel Sistemler
Aluminium Conventional Systems

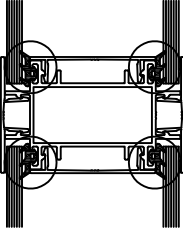
RO73

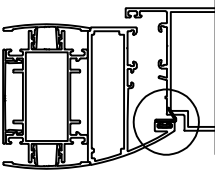
AKSESUARLAR

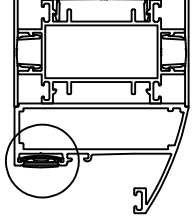
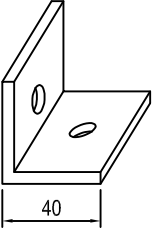
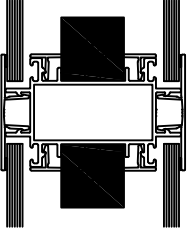
ACCESSORIES

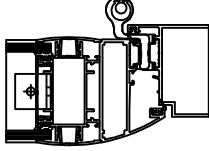
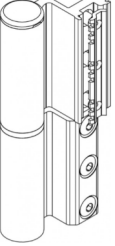
	<p>01.07.08</p> <p>ETEK ALTI FİTİLİ KICK PLATE GASKET</p> <p>Malzeme / Material : EPDM Ağırlık / Weight : 70 gr/m Paket / Package: 214m / 15 kg</p>				
	<p>01.17.11</p> <p>CAM FİTİLİ GLAZING GASKET</p> <p>Malzeme / Material : EPDM Ağırlık / Weight : 235 gr/m Paket / Package: 63.8 m / 15 kg</p>				
	<p>01.18.03</p> <p>DIŞ BİNI FİTİLİ OUTSIDE ACOUSTICAL GASKET</p> <p>Malzeme / Material : EPDM Ağırlık / Weight : 41 gr/m Paket / Package: 365 m / 15 kg</p>				
	<p>01.19.06</p> <p>ÇITA KANAL FİTİLİ ADAPTER GASKET</p> <p>Malzeme / Material : EPDM Ağırlık / Weight : 80 gr/m Paket / Package: 185 m / 15 kg</p>				
 <p>40</p>	<p>10.05.34</p> <p>BAĞLANTI PARÇASI CONNECTION PIECE</p> <p>ALÜMİNYUM 25 mm</p>				
	<p>15.02.09</p> <p>YERLİ KAPI MENTEŞESİ LOCAL HINGE FOR DOORS</p> <p>Renk: Siyah-Beyaz-Gri-Eloksal Color: Black-White-Grey-Anodised 85kg için 3adet kullanılmalıdır./Should be used 3 for 85kg. Max.kanat ölçüsü 900x2200./Max.vent dimension 900x2200</p>				
	<p>15.02.14</p> <p>GIESSE KAPI MENTEŞESİ GIESSE HINGE FOR DOORS</p> <p>Renk: Siyah-Beyaz-Gri-Eloksal Color: Black-White-Grey-Anodised</p> <p>100kg için 2adet, 120kg için 3adet kullanılmalıdır./Should be used 2for 100kg, 3for 120kg. EN 1935</p>	