

**MİMARİ KATALOG**  
**ARCHITECTURAL CATALOGUE**

**Alüminyum Sürme Sistemleri**  
Aluminium Sliding Systems

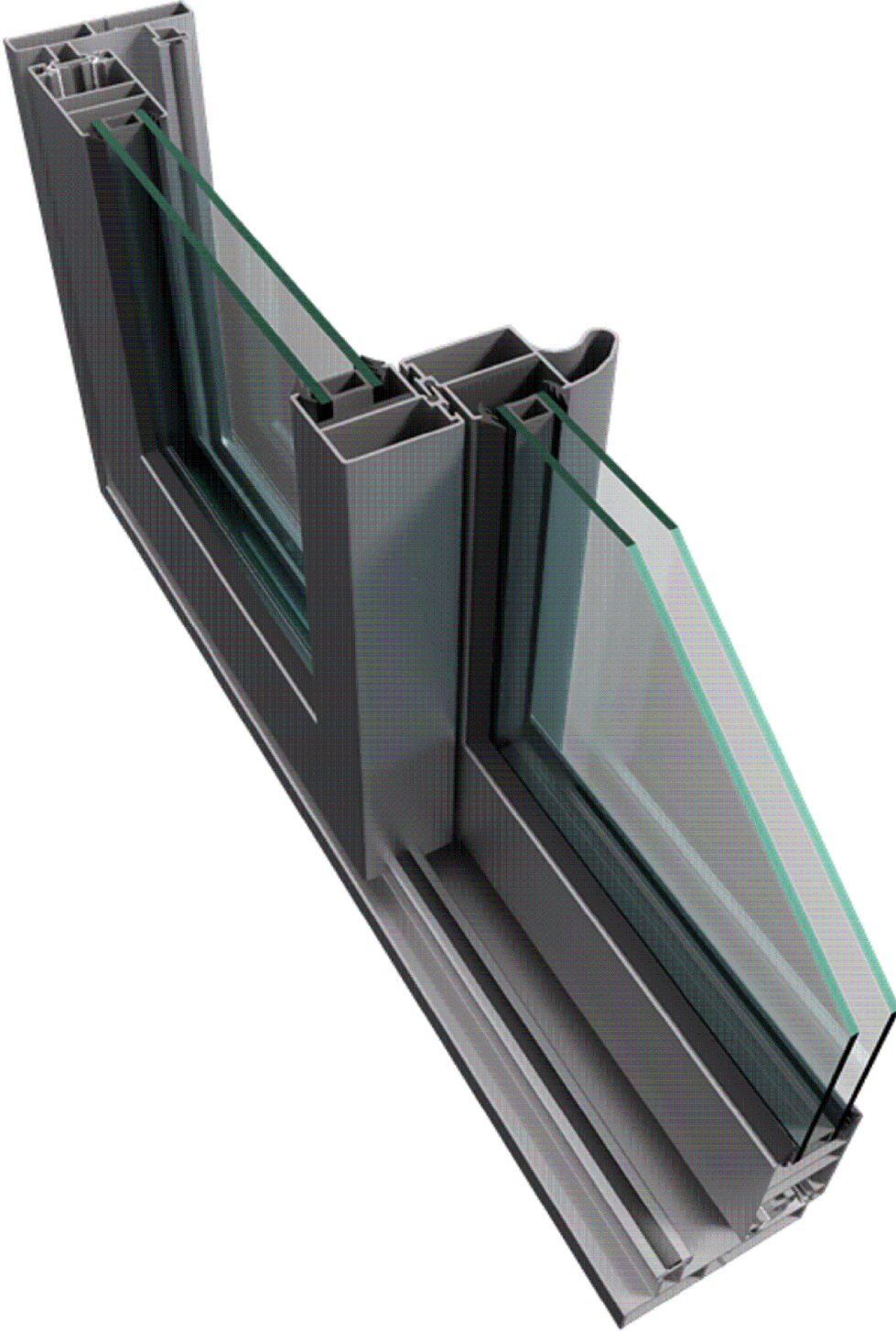

**RS83**

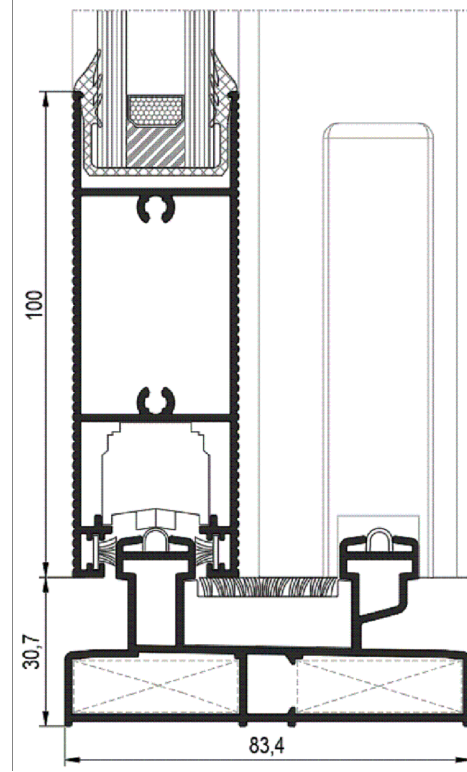
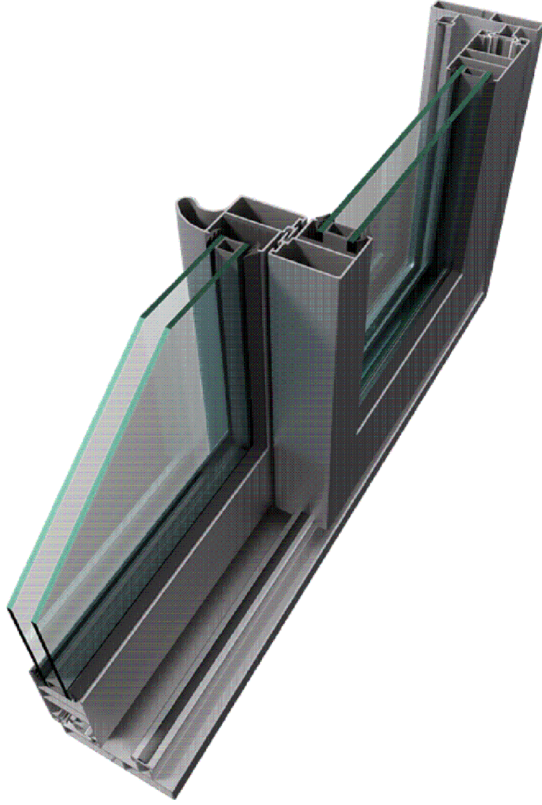

## TEKNİK ÖZELLİKLERİ / TECHNICAL PROPERTIES

<b>KASA DERİNLİĞİ</b> / <i>FRAME DEPTH</i>	min.83,4mm - max.136,4mm
<b>KANAT DERİNLİĞİ</b> / <i>VENT DEPTH</i>	min.34,2mm - max.72,8mm
<b>PROFİL ET KALINLIĞI</b> / <i>PROFILE WALL THICKNESS</i>	1,5mm
<b>CAM KALINLIĞI</b> / <i>GLASS THICKNESS</i>	8 / 10 / 20 / 24mm

## KULLANIM SEÇENEKLERİ / APPLICATION ALTERNATIVES

	<b>KAPI</b> DOOR	<b>PENCERE</b> WINDOW
<b>BASİT SÜRME</b> / <i>SLIDING</i>	•	•
<b>90° KANAT BİRLEŞİMİ</b> / <i>90° VENT COMBINATION</i>	•	•
<b>CAM ÇITASIZ KANAT</b> / <i>VENT WITHOUT GLAZING</i>	•	•
<b>SİNEKLİK</b> / <i>INSECT SCREEN</i>	•	•

RÜZGAR YÜKÜNE GÖRE KULLANIM LİMİTLERİ GRAFIĞI  
USAGE DIAGRAM FOR THE WIND LOAD

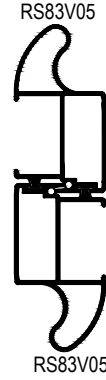
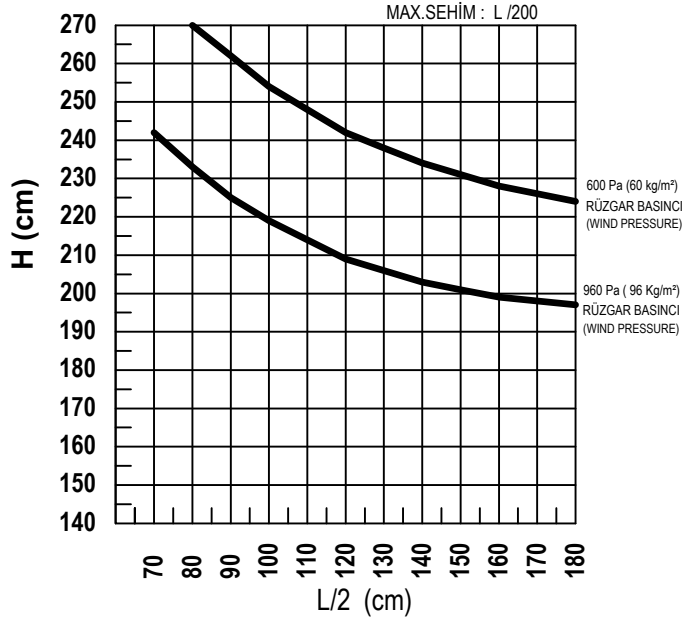
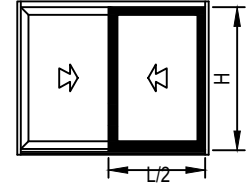

RS83V05 Jx: 17,252 cm<sup>4</sup>  
RS83V05 Jx: 17,252 cm<sup>4</sup>  
TOPLAM Jx: 34,504 cm<sup>4</sup>

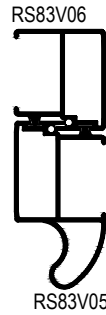
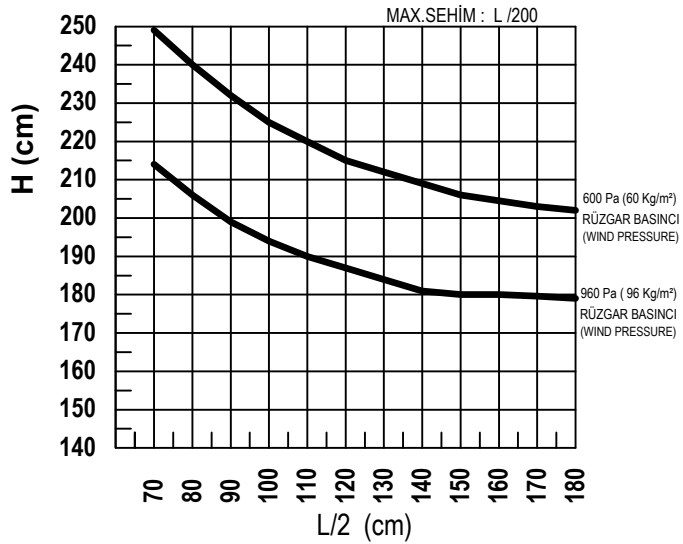

RS83V06 Jx: 6,384 cm<sup>4</sup>  
RS83V05 Jx: 17,252 cm<sup>4</sup>  
TOPLAM Jx: 23,636 cm<sup>4</sup>

\*Rüzgar yükü ve cam ebatlarına göre kullanılacak cam kombinasyonu için, cam tedarikçisinden onay alınmalıdır.  
Approval should be obtained from a glass supplier for the glass combination to be used according to the wind load and glass dimensions.

\*Kanat takozlama ve camlama tipi, açılım aksesuar ve rulman limitleri ayrıca kontrol edilmelidir.  
Vent wedging and glazing types, as well as opening accessory and pulley limits must also be checked.

## RÜZGAR YÜKÜNE GÖRE KULLANIM LİMİTLERİ GRAFİĞİ USAGE DIAGRAM FOR THE WIND LOAD

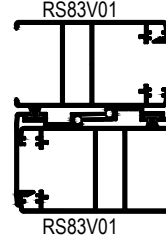
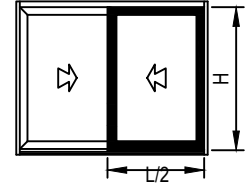
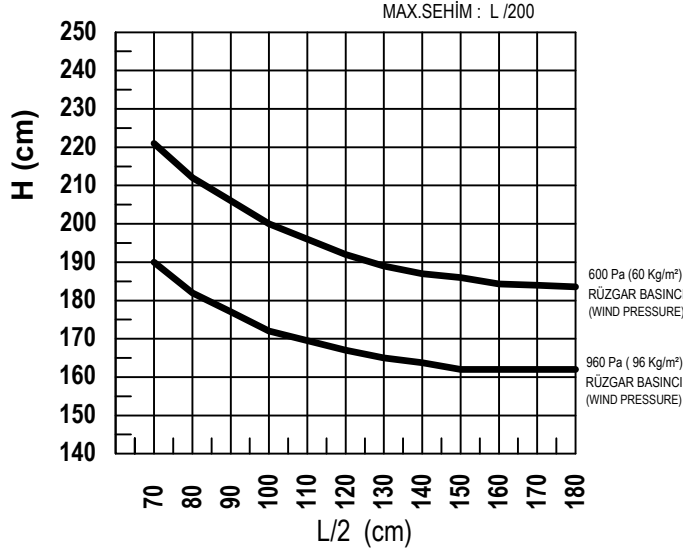

RS83V01 Jx: 8,141 cm<sup>4</sup>  
RS83V01 Jx: 8,141 cm<sup>4</sup>  
TOPLAM Jx: 16,282 cm<sup>4</sup>

\*Rüzgar yükü ve cam ebatlarına göre kullanılacak cam kombinasyonu için, cam tedarikçisinden onay alınmalıdır.  
Approval should be obtained from a glass supplier for the glass combination to be used according to the wind load and glass dimensions.

\*Kanat takozlama ve camlama tipi, açılım aksesuar ve rulman limitleri ayrıca kontrol edilmelidir.  
Vent wedging and glazing types, as well as opening accessory and pulley limits must also be checked.

SİSTEM TİPOLOJİSİ  
SYSTEM TYPOLOGY

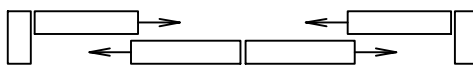
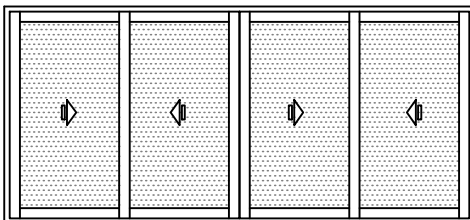
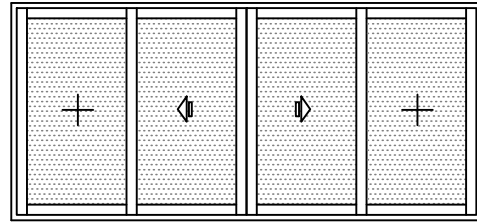
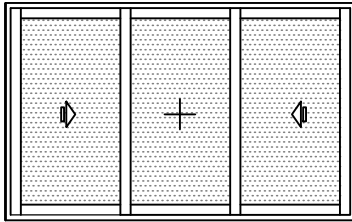
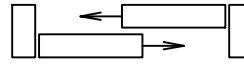
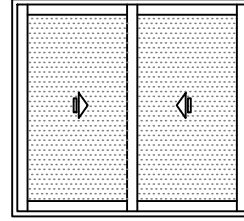
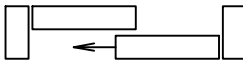
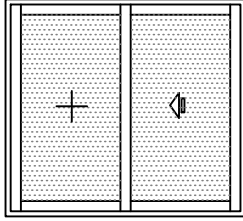

**MİMARİ KATALOG**  
**ARCHITECTURAL CATALOGUE**

**Alüminyum Sürme Sistemleri**  
Aluminium Sliding Systems

# RS83

**PROFİLLER**

**PROFILES**

KOD / CODE	AĞIRLIK (kg/m) / WEIGHT	Jxx cm <sup>4</sup>	Jyy cm <sup>4</sup>	L m	
RS83F01	1,373	7,823	30,747	6	
RS83F02	1,558	8,922	44,572	6	
RS83F03	-----	-----	-----	6	

RS83F01

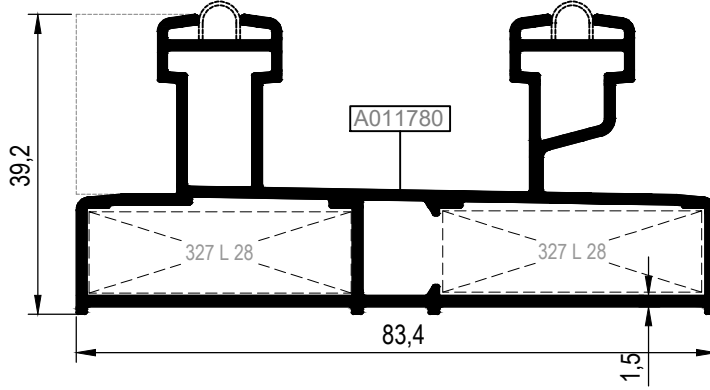

RS83F02

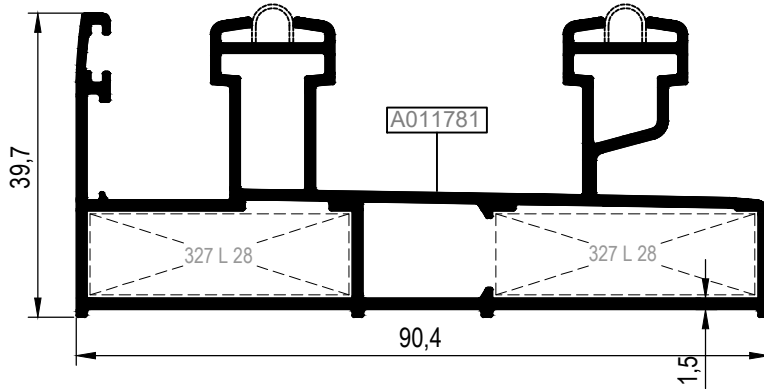

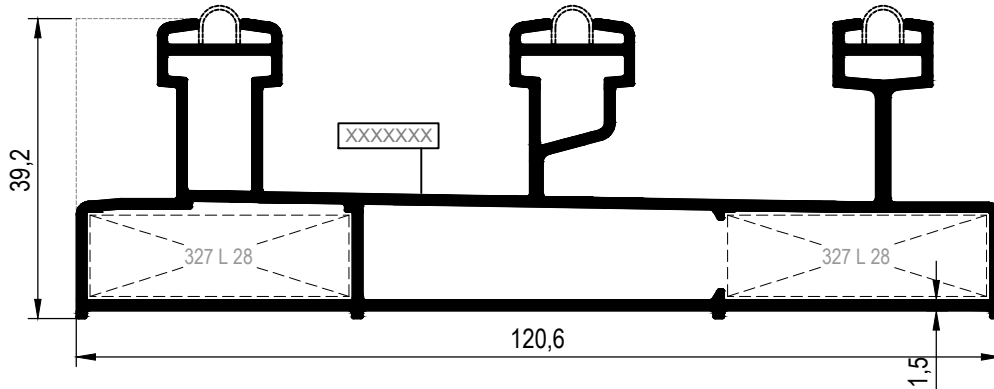

\*\*RS83F03

Sineklik Kanadı için Kasa



\*\*Kalıp aktif değildir. Sipariş üzerine yapılacaktır.  
The die is not active. It will be produced by order.

Nr		 L m	KEŞİM ÖLÇÜSÜ CUTTING SIZE	 AKS. KODU ACS. CODE
RS83F01	A011780	25L28 (A010542)	34,2 mm	327 L 28
RS83F02	A011781	25L28 (A010542)	34,2 mm	327 L 28
RS83F03	-----	25L28 (A010542)	34,2 mm	327 L 28

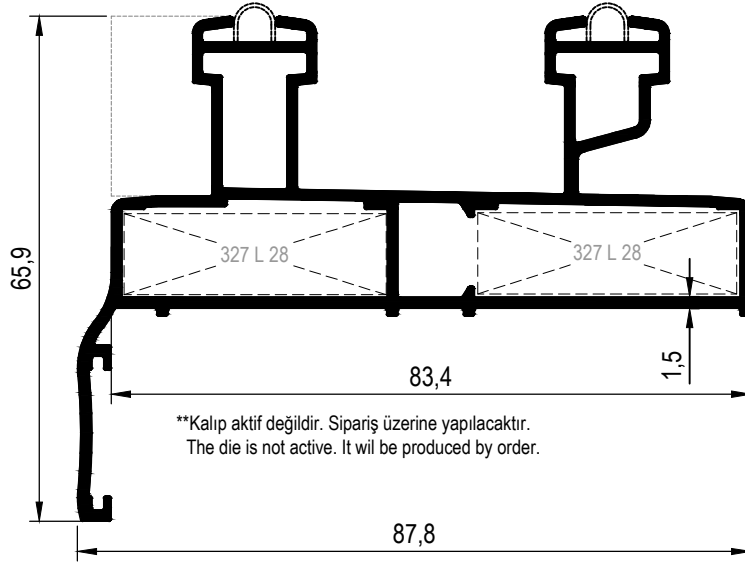

KOD / CODE	AĞIRLIK (kg/m) / WEIGHT	Jxx cm <sup>4</sup>	Jyy cm <sup>4</sup>	L m	
RS83F04	-----	-----	-----	6	
RS83F05	2,258	17,642	140,921	6	

\*\*RS83F04

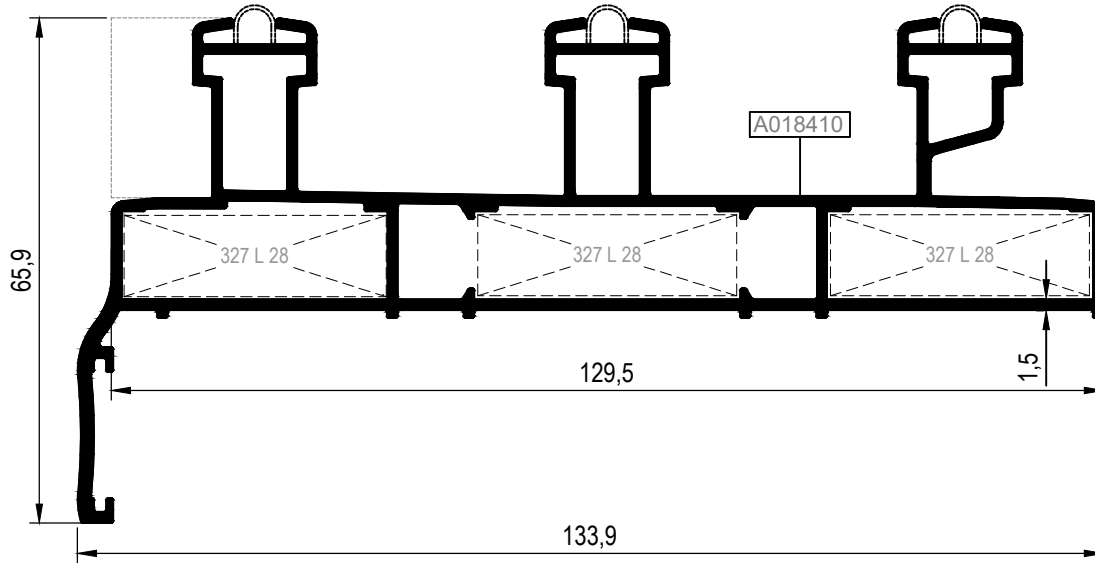

RS83F05



Nr	 L m	KESİM ÖLÇÜSÜ CUTTING SIZE	 AKS. KODU ACS. CODE
RS83F04	-----	25L28 (A010542)	327 L 28
RS83F05	A018410	25L28 (A010542)	327 L 28

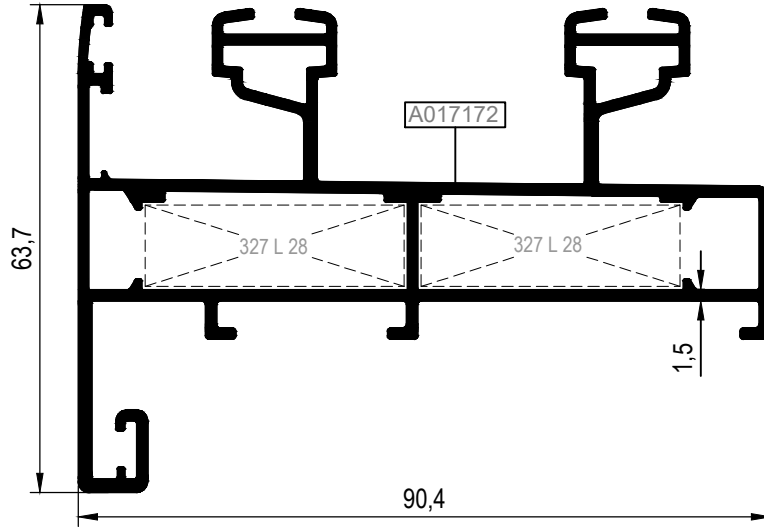

KOD / CODE	AĞIRLIK (kg/m) / WEIGHT	Jxx cm <sup>4</sup>	Jyy cm <sup>4</sup>	L m	
RS83F06	1,881	17,305	59,589	6	
RS83F07	2,278	17,986	139,426	6	

RS83F06

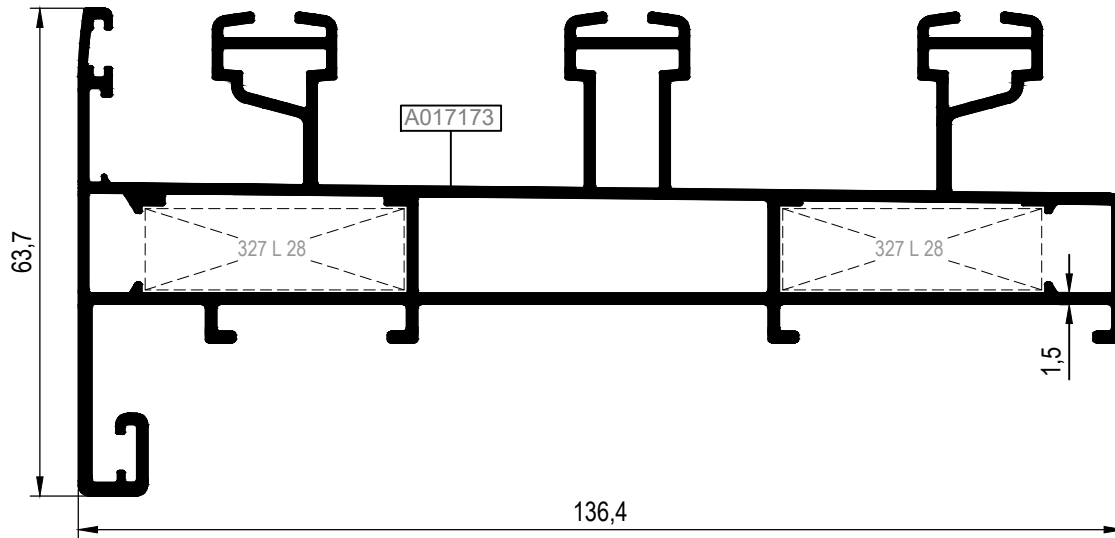

RS83F07



Nr		 L m	KEŞİM ÖLÇÜSÜ CUTTING SIZE	 AKS. KODU ACS. CODE
RS83F06	A017172	25L28 (A010542)	34,2 mm	327 L 28
RS83F07	A017173	25L28 (A010542)	34,2 mm	327 L 28

KOD / CODE	AĞIRLIK (kg/m) / WEIGHT	Jxx cm <sup>4</sup>	Jyy cm <sup>4</sup>	L m	
RS83V01	0,940	8,141	12,328	6	
RS83V02	1,216	18,027	16,884	6	
RS83V03	0,996	8,353	12,334	6	

RS83V01

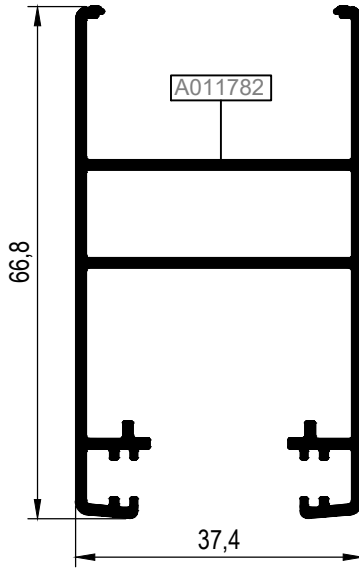

RS83V02

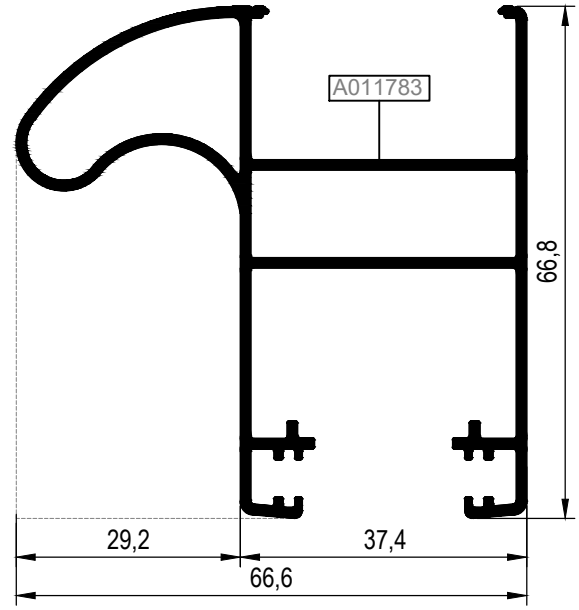

RS83V03

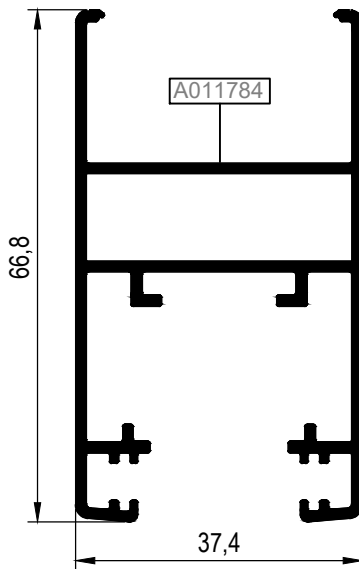

KOD / CODE	AĞIRLIK (kg/m) / WEIGHT	Jxx cm <sup>4</sup>	Jyy cm <sup>4</sup>	L m	
RS83V04	1,273	40,427	9,294	6	
RS83V05	0,937	17,252	4,748	6	
RS83V06	0,661	6,384	3,209	6	

RS83V04

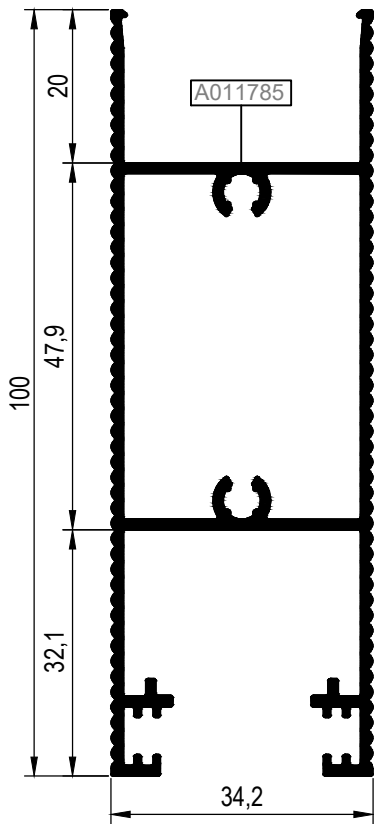

RS83V05

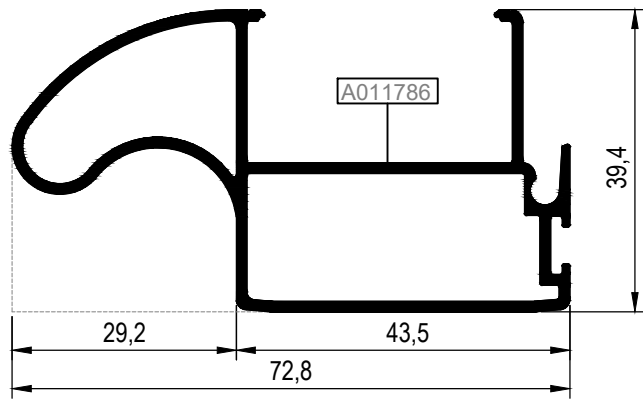

RS83V06

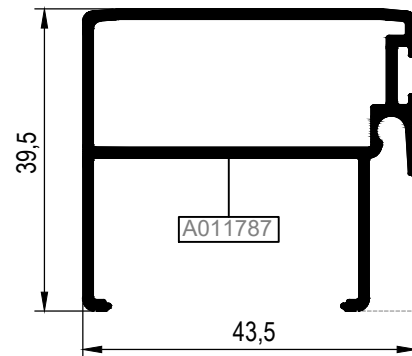

KOD / CODE	AĞIRLIK (kg/m) / WEIGHT	Jxx cm <sup>4</sup>	Jyy cm <sup>4</sup>	L m	
RS83A02	0,379	2,353	1,808	6	
RS83A03	0,254	0,428	0,872	6	
RS83A04	0,509	3,445	1,284	6	
TS58V06	0,917	4,270	10,506	6	
25I07	0,143	----	----	6	

RS83A02

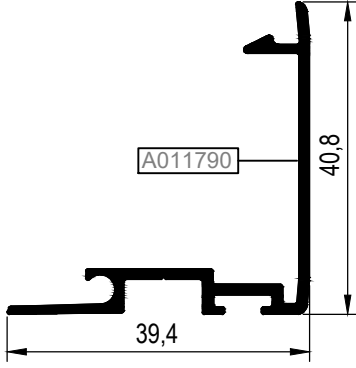

RS83A03

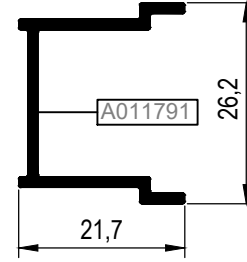

RS83A04

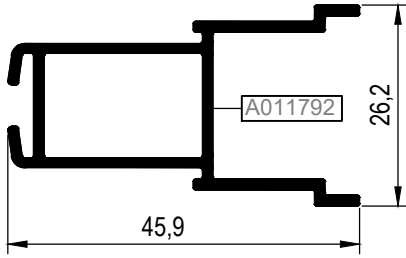

TS58V06

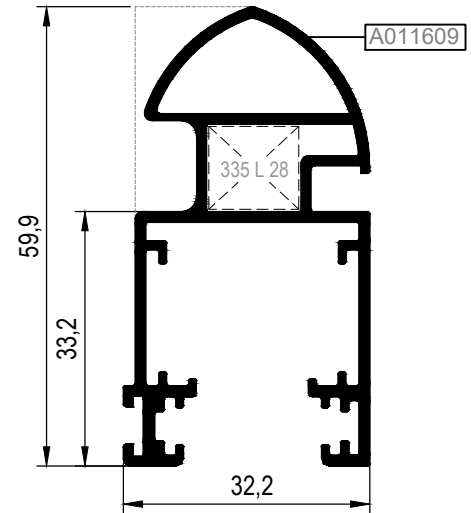

25I07



KÖŞE TAKOZLARI (CORNER CLEATS)	
PROFİL KODU (PROFILE CODE)	25L28
FABRİKA KODU (FACTORY CODE)	A010542
AĞIRLIK (WEIGHT)	3,689 kg/m
ÇİZİM (DRAWING)	

KÖŞE TAKOZLARI (CORNER CLEATS)				
Nr		L m	KESİM ÖLÇÜSÜ CUTTING SIZE	AKS. KODU ACS. CODE
RS83F01	A011780	25L28 (A010542)	34,2 mm	327 L 28
RS83F02	A011781	25L28 (A010542)	34,2 mm	327 L 28
RS83F03	-----	25L28 (A010542)	34,2 mm	327 L 28
RS83F04	-----	25L28 (A010542)	34,2 mm	327 L 28
RS83F05	A018410	25L28 (A010542)	34,2 mm	327 L 28
RS83F06	A017172	25L28 (A010542)	34,2 mm	327 L 28
RS83F07	A017173	25L28 (A010542)	34,2 mm	327 L 28
TS58V06	A011609	25L28(A010542)	12,0 mm	335 L 28

**MİMARİ KATALOG**  
**ARCHITECTURAL CATALOGUE**

**Alüminyum Sürme Sistemleri**  
Aluminium Sliding Systems

# RS83

**DETAYLAR**

**DETAILS**

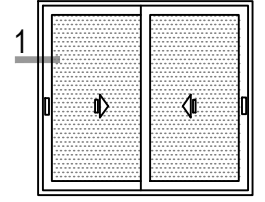
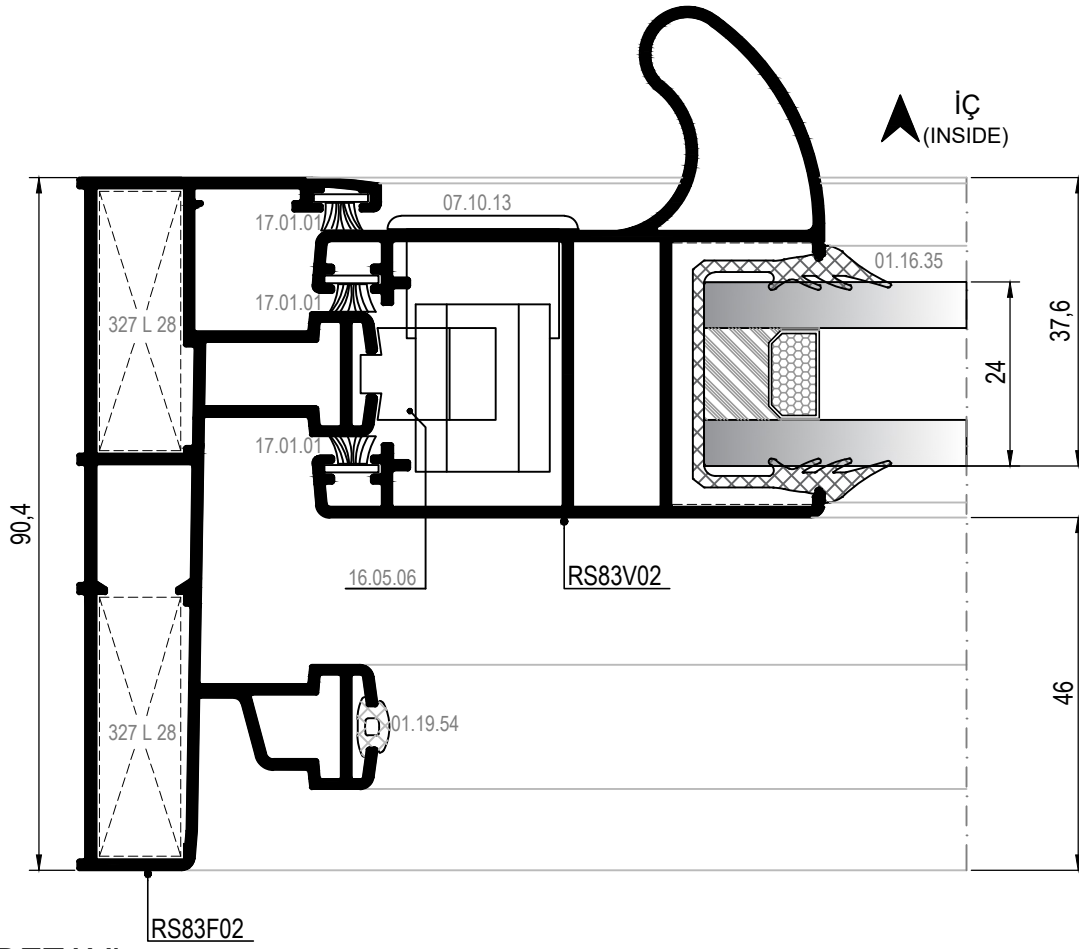

① DETAYI  
DETAIL

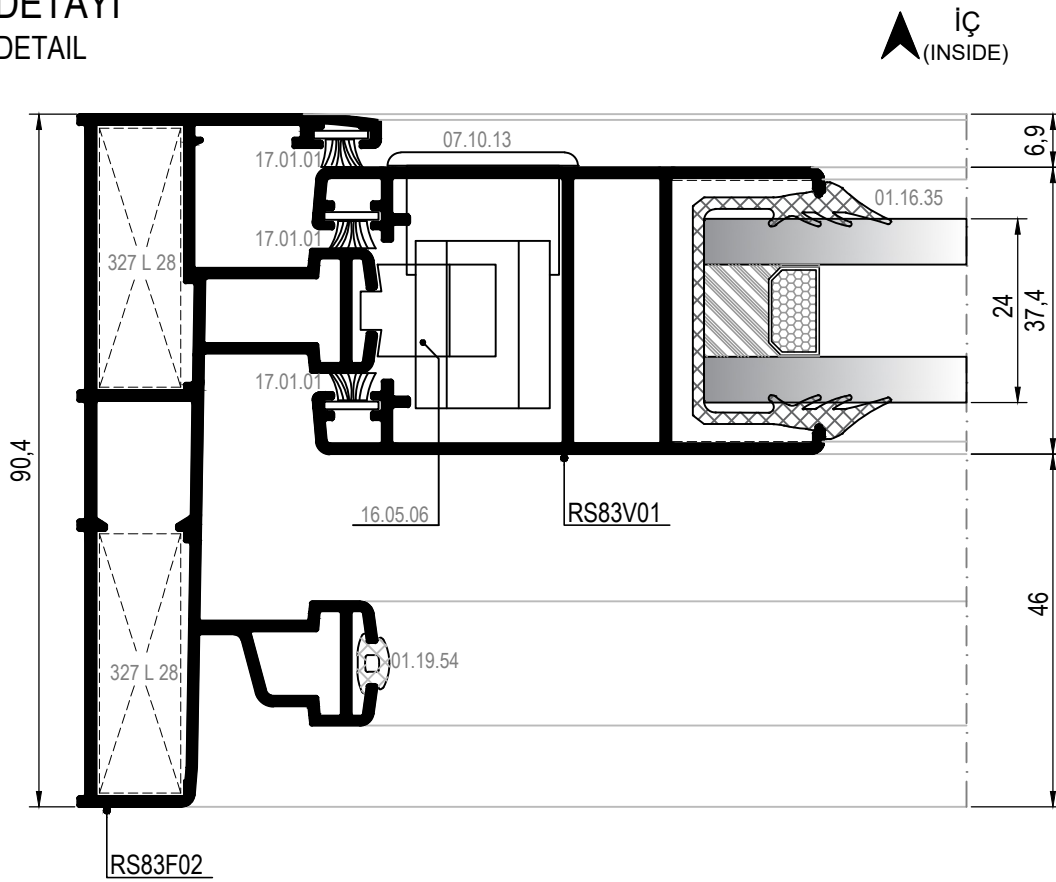

①A DETAYI  
DETAIL

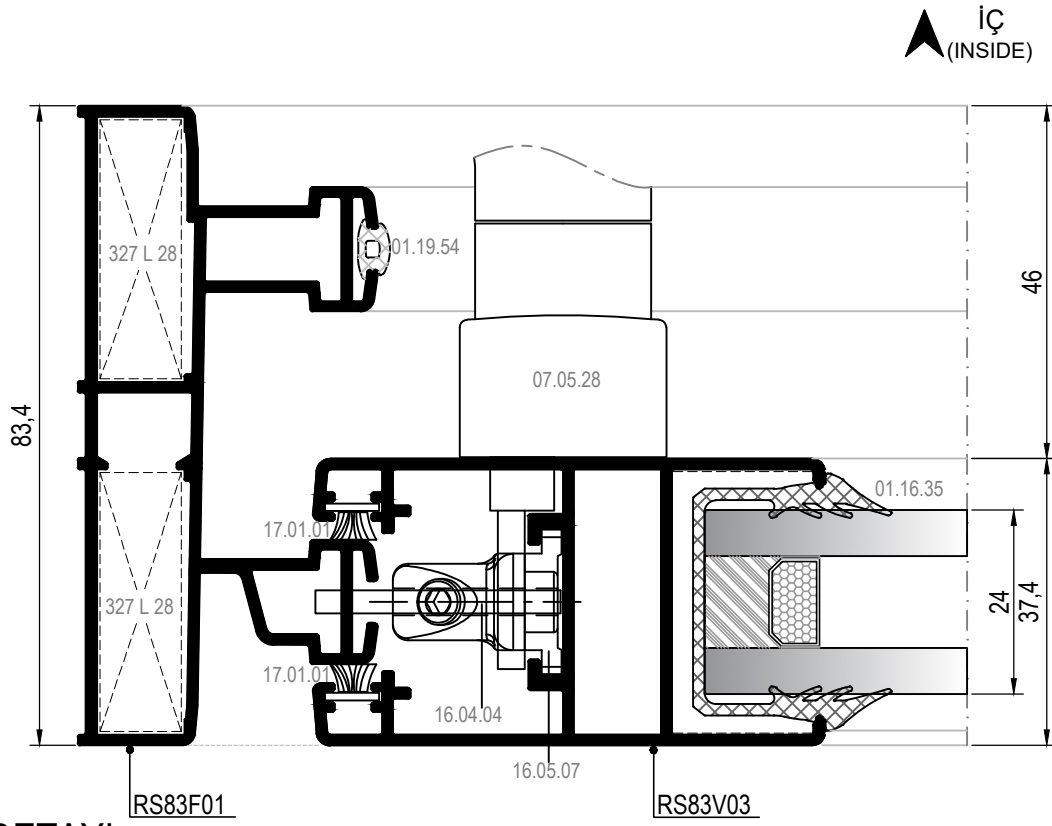
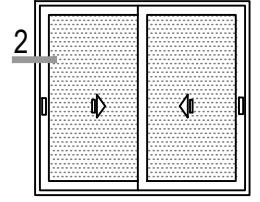

② DETAYI  
DETAIL

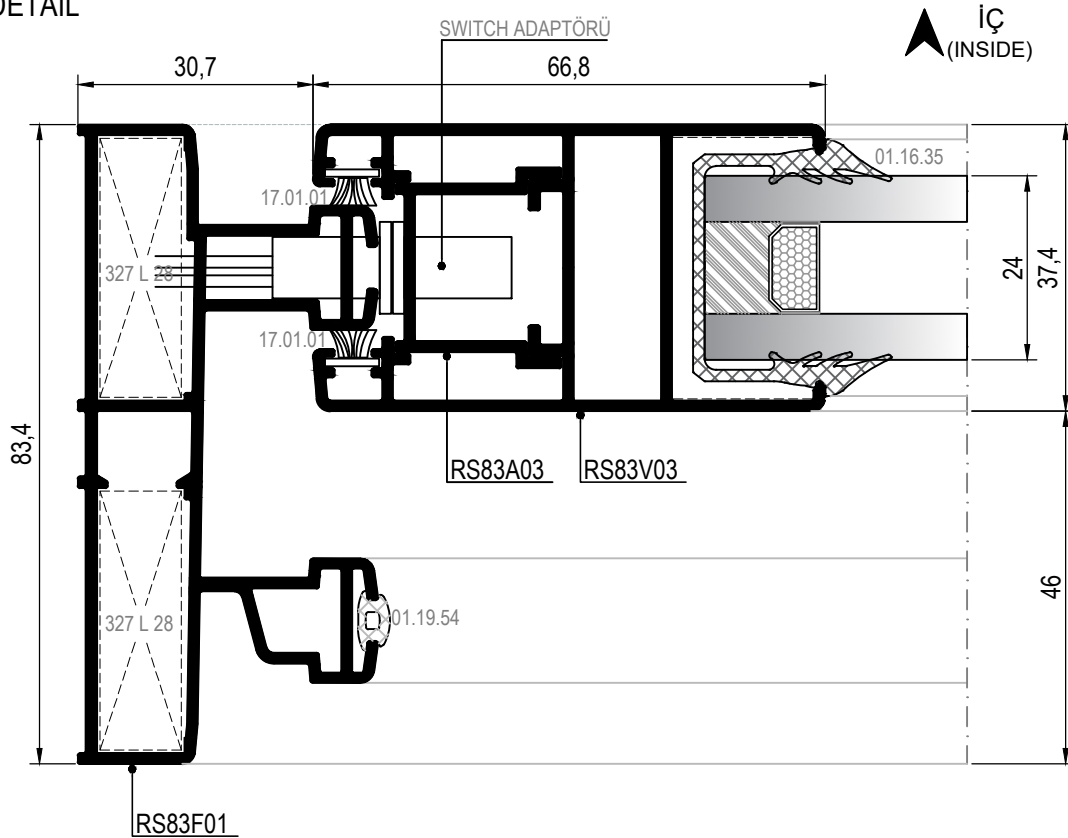

SWITCH DETAYI  
SWITCH DETAIL

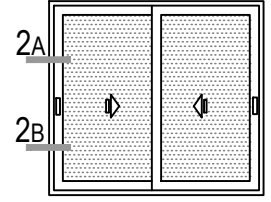

İÇ  
(INSIDE)

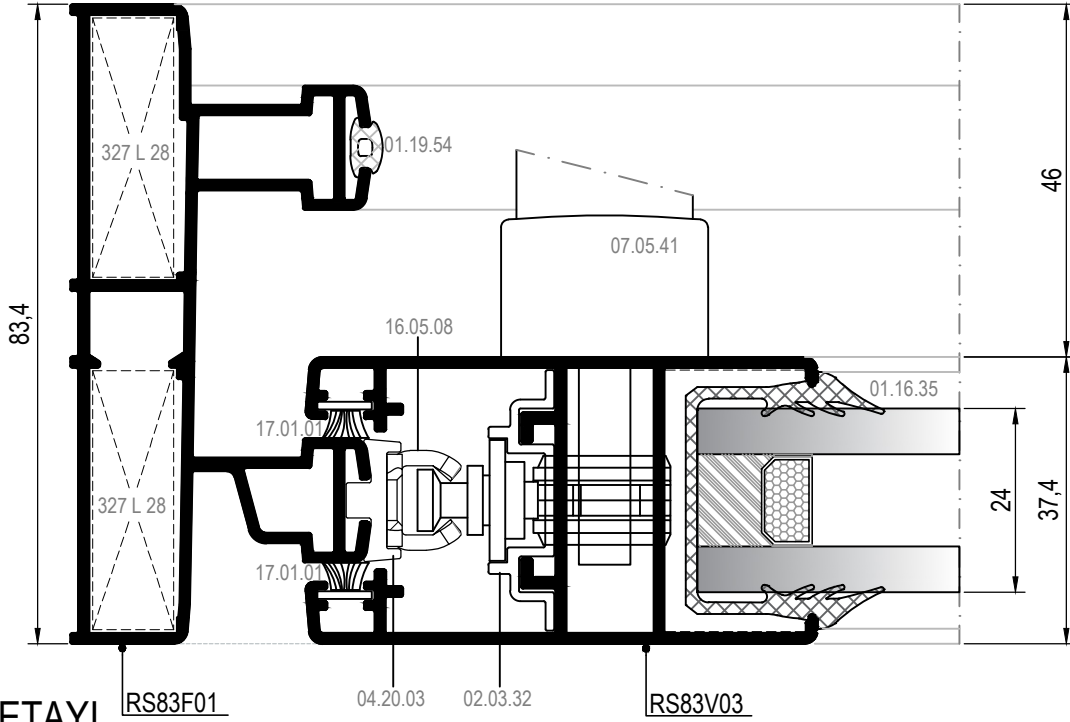

2A  
DETAYI  
DETAIL

İÇ  
(INSIDE)

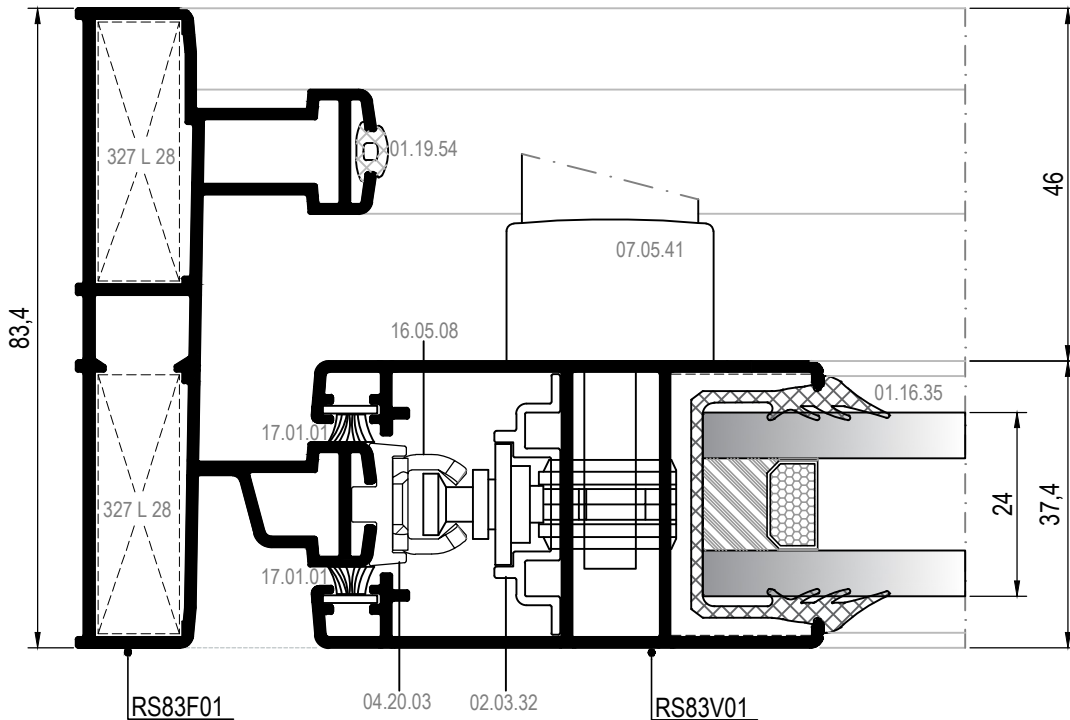

2B  
DETAYI  
DETAIL

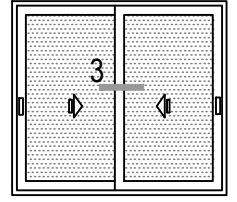

▲ İÇ  
(INSIDE)

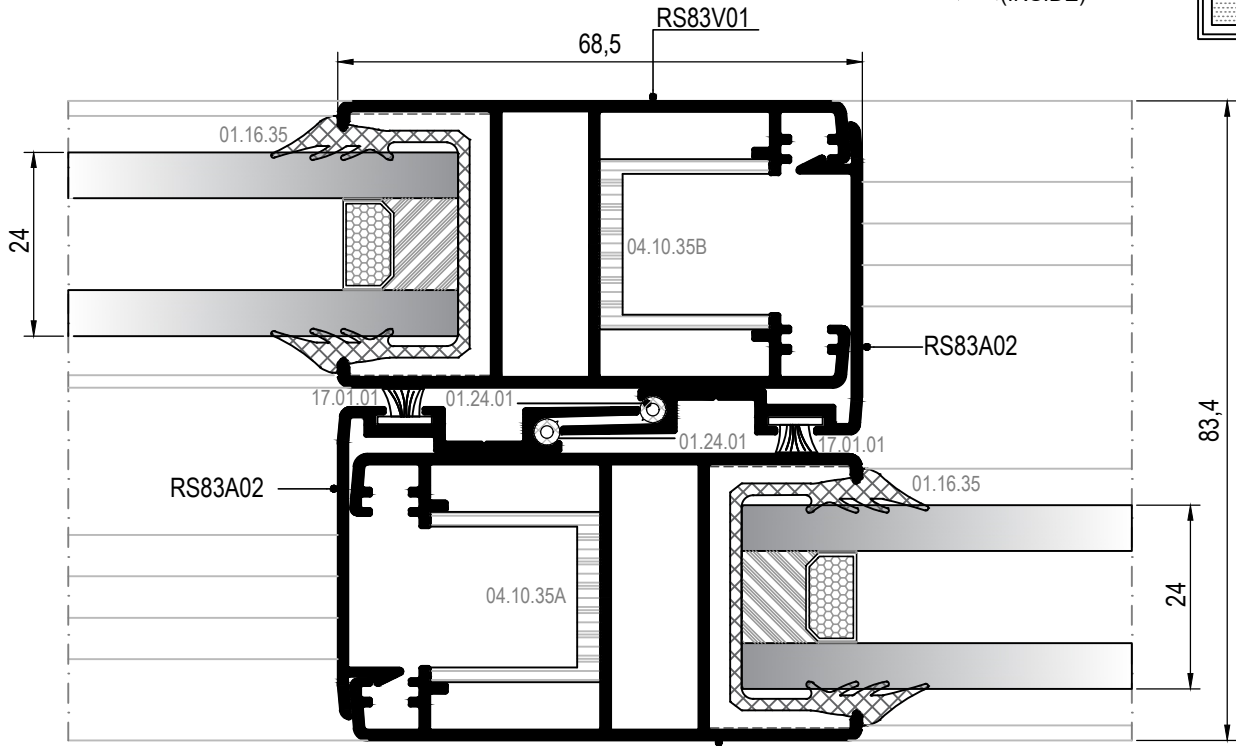

③ DETAYI  
DETAIL

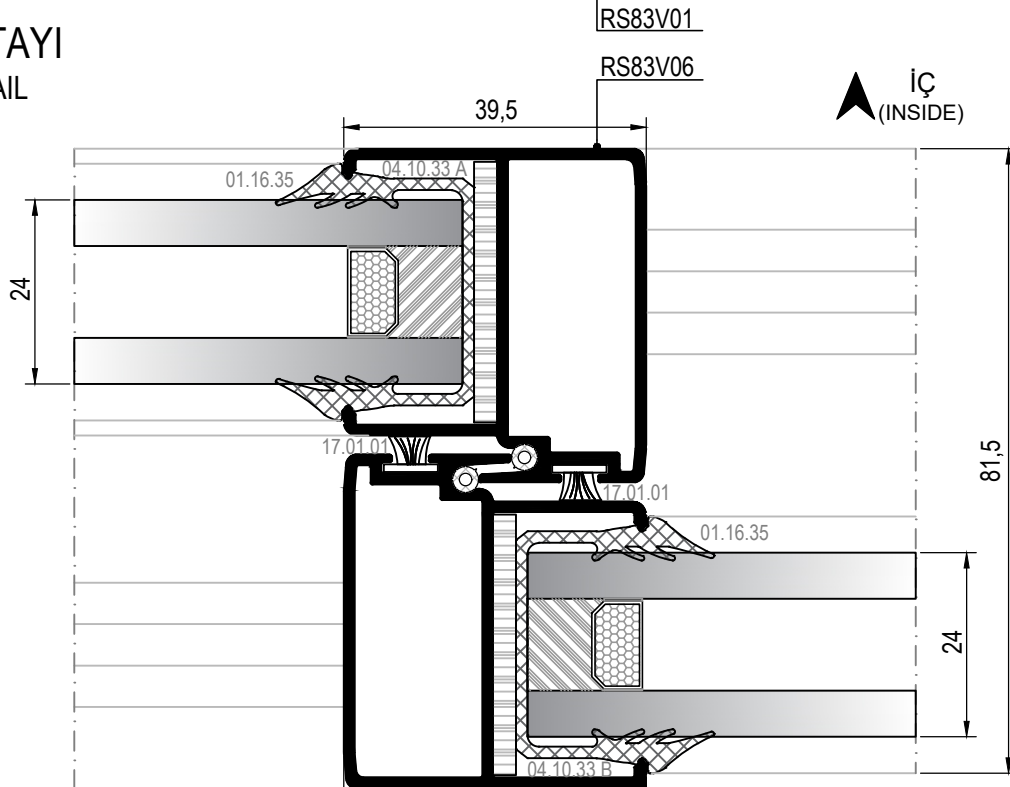

▲ İÇ  
(INSIDE)

③A DETAYI  
DETAIL

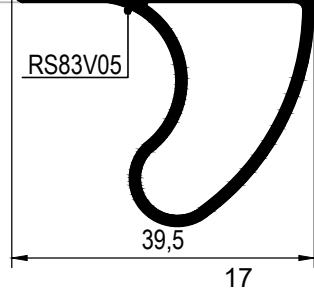

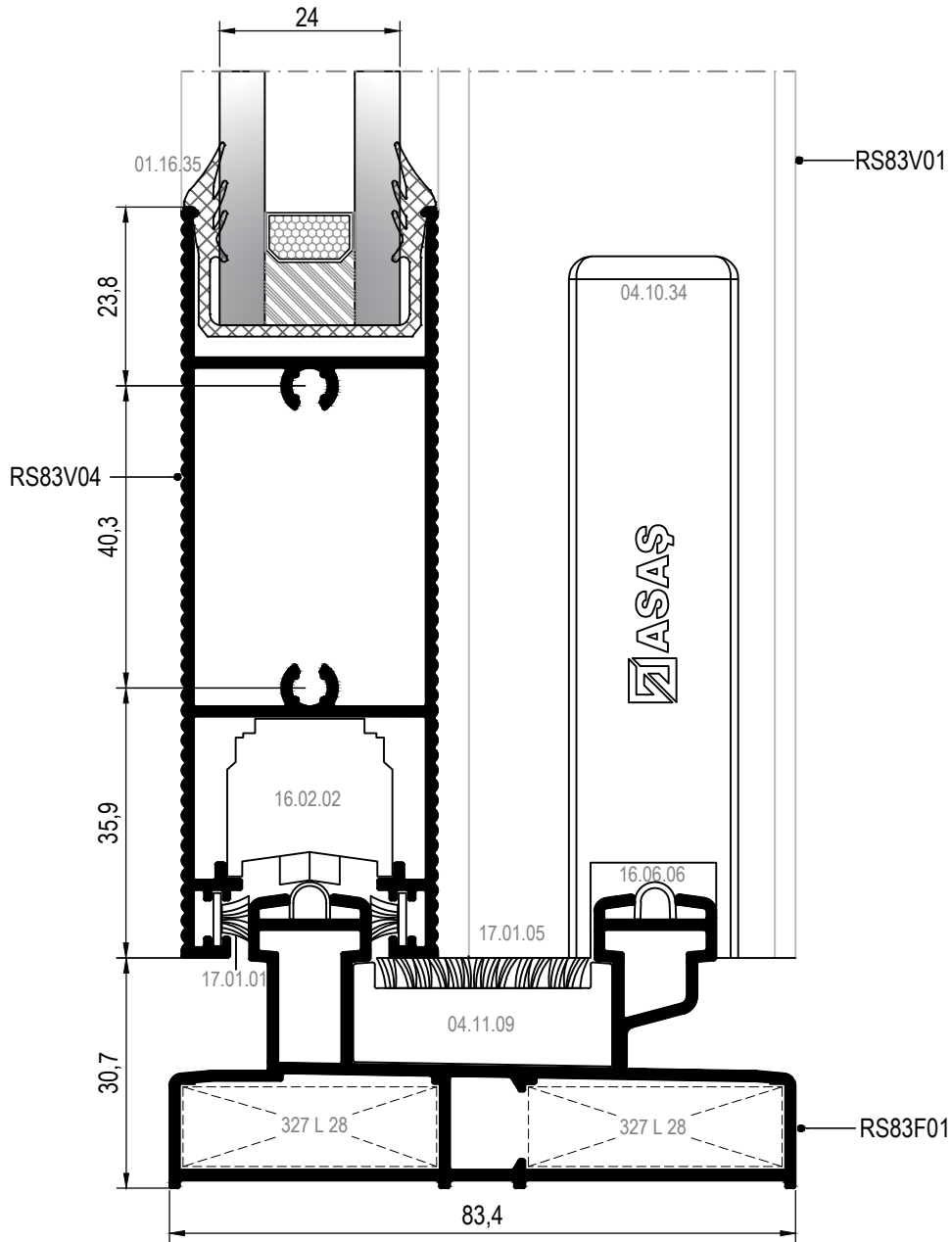
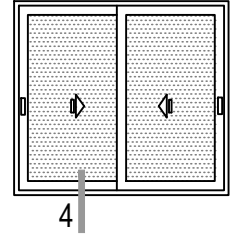

④ DETAYI  
DETAIL

DIŞ  
(OUTSIDE) ➔

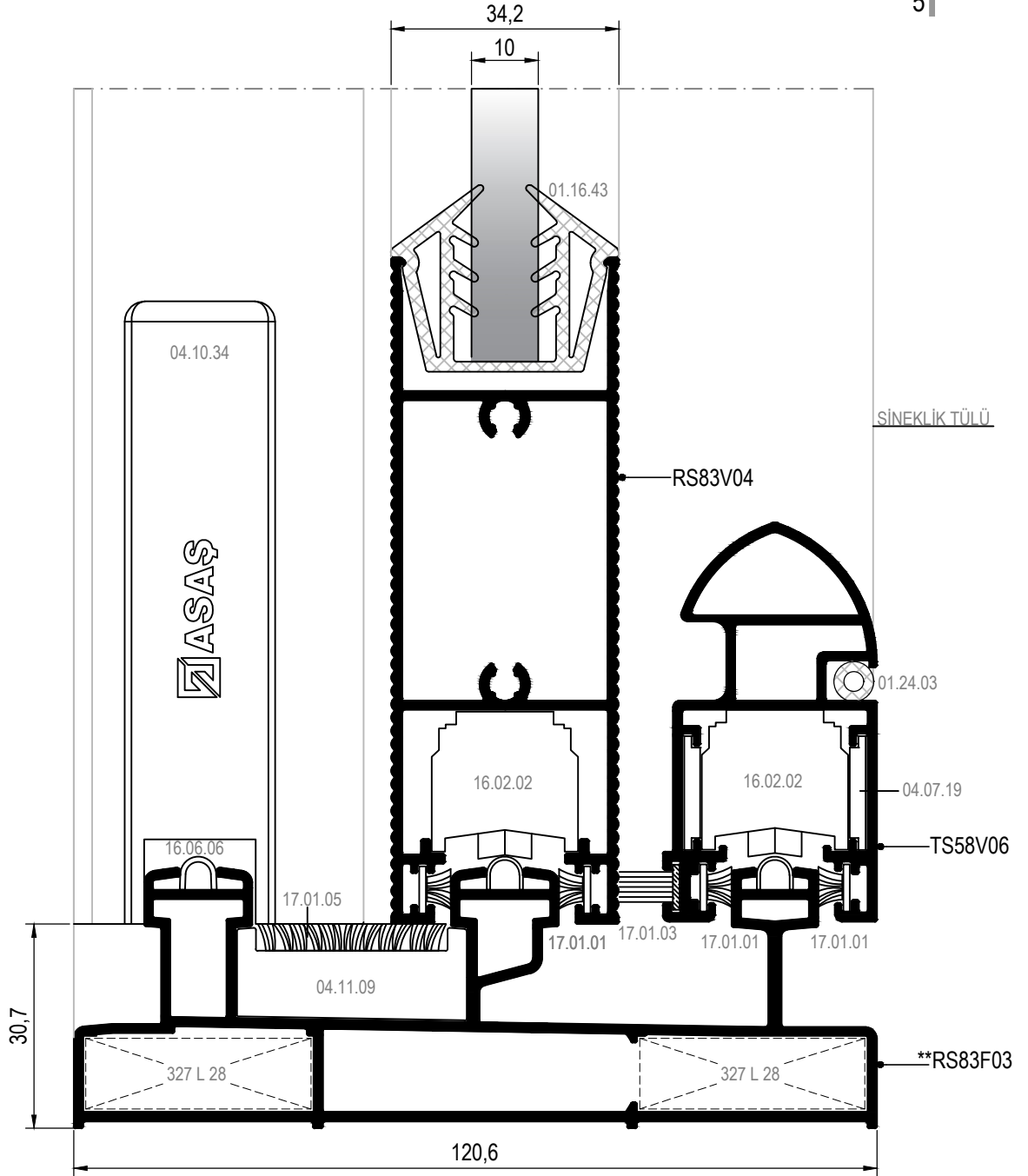
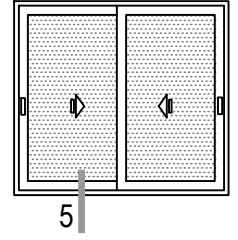

\*\*Kalıp aktif değildir. Sipariş üzerine yapılacaktır.  
The die is not active. It will be produced by order.

⑤ DETAYI  
DETAIL

DIŞ  
(OUTSIDE) ➔

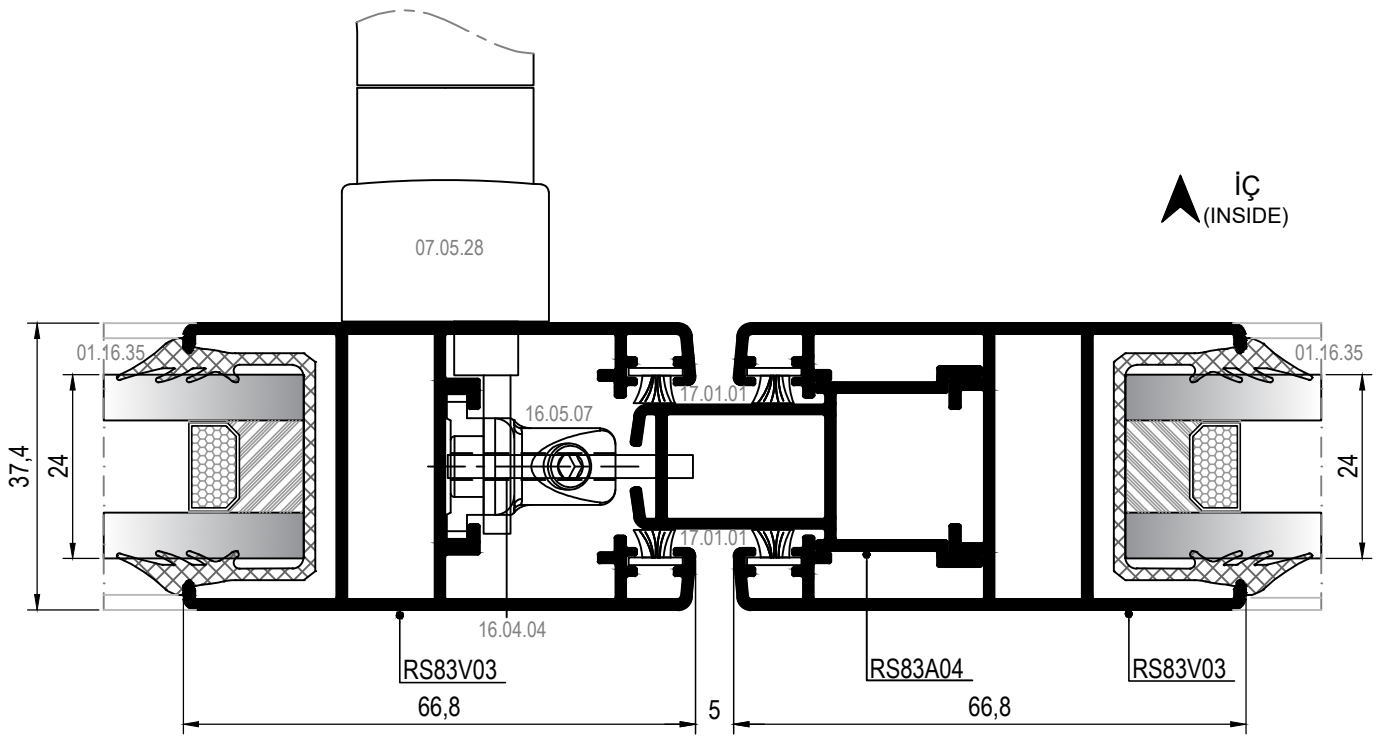
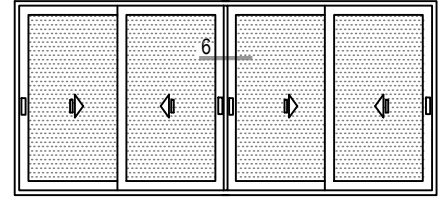

⑥ DETAYI  
DETAIL

## PROFİLLER / Profiles

KOD Code	PROFİL Profile	ADET Unit	KESİM ÖLÇÜSÜ Cutting Dimension
RS83F01	A	2	L
		2	H
RS83V01	B	2	H - 65
RS83V04	G	4	L / 2 - 80,8
RS83V05		1	H - 65
RS83V06		1	H - 65
CAM /Glass		2	L / 2 - 87,4
		2	H - 231,6

## FİTİLLER/ Gaskets

01.16.35	CAM U FİTİLİ / U Glazing Gasket		4H+2L
01.19.54	RAY FİTİLİ / Rail Gasket		4H+2L
01.24.01	MT-216 KENET FİTİLİ / Connection Gasket		2(H - 65)
16.06.06	ÇELİK RAY / Steel Rail		2L
17.01.01	KİL FİTİL / Brush Seal		6H+4L
*17.01.05	KİL FİTİL / Brush Seal		256mm

\*17.01.05 , 04.11.09notlu aksesuar için kullanılır. 04.11.09notlu aksesuar adedi x 128 mm

## AKSESUARLAR/ Accessories

KOD Code	AÇIKLAMA Description	ADET Unit	KESİM ÖLÇÜSÜ Cutting Dimension
327 L 28	KÖŞE TAKOZU / Corner Cleat	8	
04.10.34	PVC KAPAK / PVC Cap	4	
04.10.33A	PVC KAPAK (SOL) / PVC Cap (Left)	2	
04.10.33B	PVC KAPAK (SAĞ) / PVC Cap (Right)	2	
04.11.09	ALT-ÜST SEVİYE TAKOZU Bottom-Upper Leveling Cleat	2	
04.10.35A	PVC KAPAK (SOL) / PVC Cap (Left)	2	
04.10.35B	PVC KAPAK (SAĞ) / PVC Cap (Right)	2	
04.10.36A	PVC KAPAK (SOL) / PVC Cap (Left)	2	
04.10.36B	PVC KAPAK (SAĞ) / PVC Cap (Right)	2	
07.10.13	HAVUZLU KİLİT / Sliding Lock	2	
16.05.06	SÜRME KİLİT ADAPTÖRÜ/ Sliding Lock Adapter	2	
07.11.03	KOL ÜSTÜ KARŞILIK/ Striker For Handle	2	
16.02.02	RULMAN / Giesse Adjustable Carrera	4	

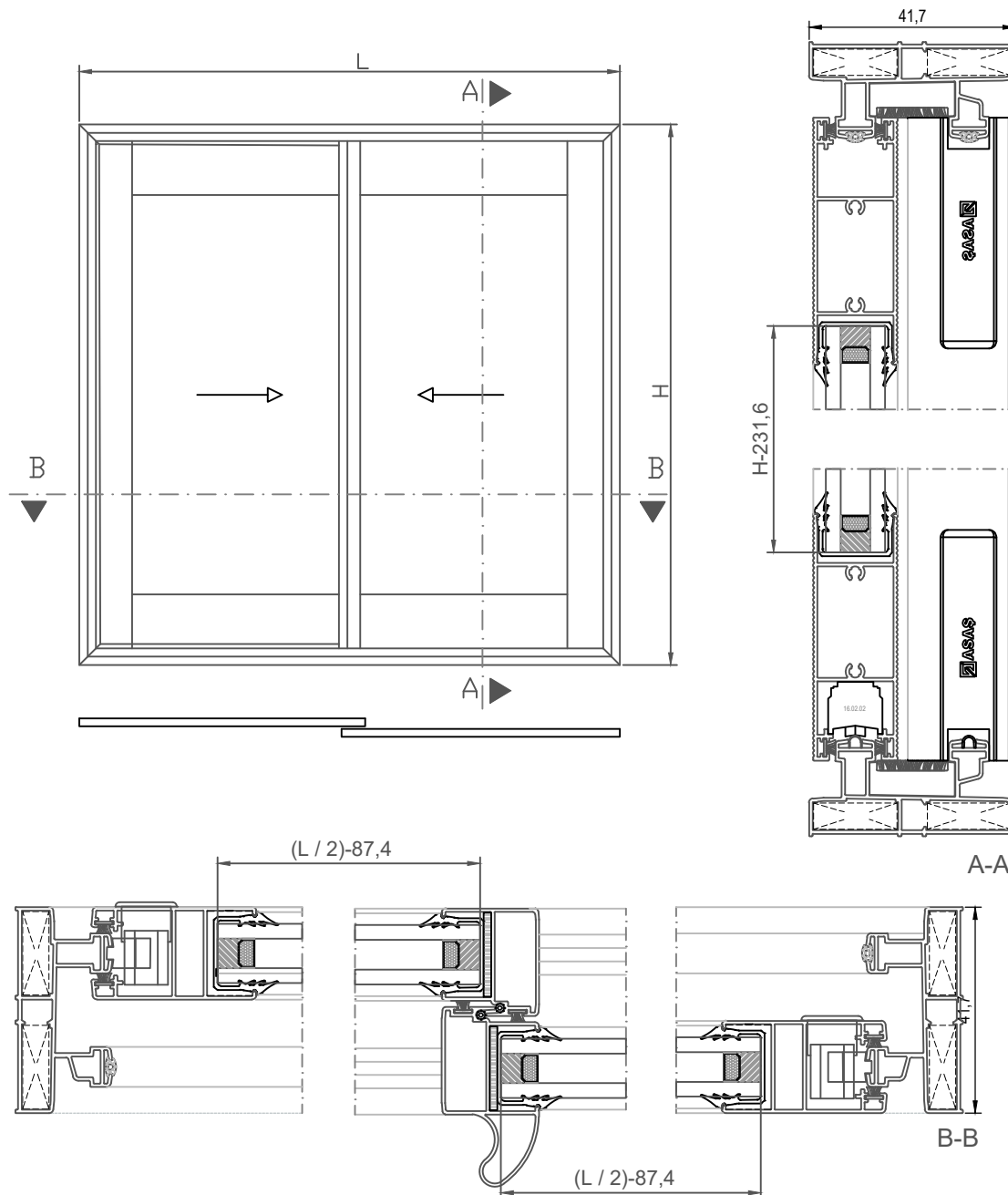

ÖLÇEK / Scale: 1/2











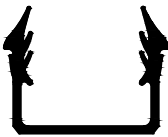
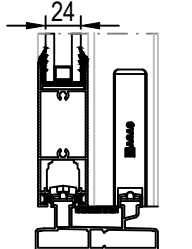

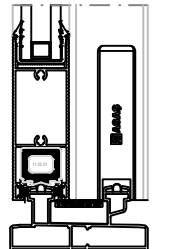
**MİMARİ KATALOG**  
**ARCHITECTURAL CATALOGUE**

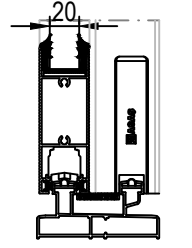
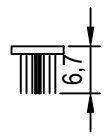
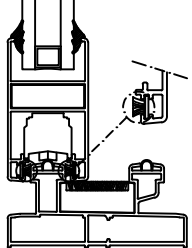
**Alüminyum Sürme Sistemleri**  
Aluminium Sliding Systems

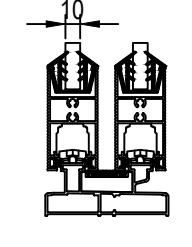
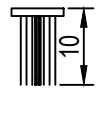
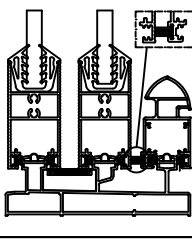
# RS83

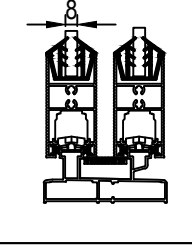
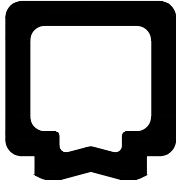
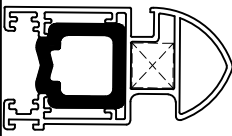
**AKSESUARLAR**

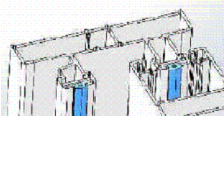
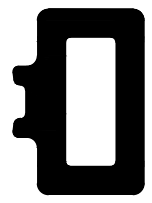
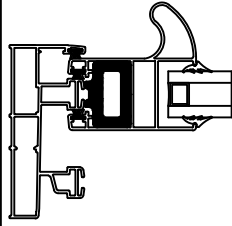
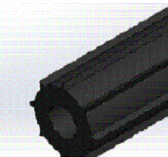
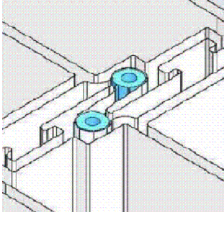
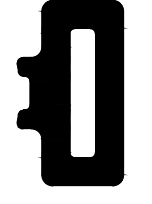
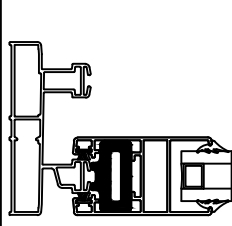
**ACCESSORIES**

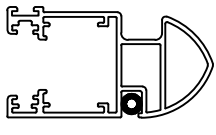
	<p><b>01.16.35</b></p> <p>CAM FİTİLİ GLAZING GASKET</p> <p>Malzeme / Material : EPDM Ağırlık / Weight : 240 gr/m Paket / Package: 62 m / 15 kg</p>			<p><b>11.05.01</b></p> <p>KANAT SABİTLEME TAKOZU VENT FIXING PART</p> <p>Malzeme / Material : PVC</p>	
	<p><b>01.16.36</b></p> <p>CAM FİTİLİ GLAZING GASKET</p> <p>Malzeme / Material : EPDM Ağırlık / Weight : 310 gr/m Paket / Package: 48 m / 15 kg</p>			<p><b>17.01.01</b></p> <p>KIL FİTİL 670X700 BRUSH 670X700</p> <p>Malzeme / Material Polipropilen / Polypropilene Paket / Package : 275 mt</p>	
	<p><b>01.16.43</b></p> <p>CAM FİTİLİ GLAZING GASKET</p> <p>Malzeme / Material : EPDM Ağırlık / Weight : 445 gr/m Paket / Package: 39 m / 15 kg</p>			<p><b>17.01.03</b></p> <p>KIL FİTİL BRUSH</p> <p>Paket: 200 mt Package: 200 mt</p>	
	<p><b>01.16.44</b></p> <p>CAM FİTİLİ GLAZING GASKET</p> <p>Malzeme / Material : EPDM Ağırlık / Weight : 441 gr/m Paket / Package: 34 m / 15 kg</p>			<p><b>19.01.10</b></p> <p>STOPER STOPER</p> <p>Malzeme / Material : EPDM (TS58 V 06 için / for TS58 V 06 )</p>	
	<p><b>01.19.54</b></p> <p>CAM FİTİLİ GLAZING GASKET</p> <p>Malzeme / Material : EPDM Ağırlık / Weight : 28 gr/m Paket / Package: 535 m / 15 kg</p>			<p><b>19.01.12</b></p> <p>STOPER STOP</p> <p>Malzeme / Material : EPDM</p>	
	<p><b>01.24.01</b></p> <p>MT-216 A KENET FİTİLİ CONNECTION GASKET</p> <p>Malzeme / Material : EPDM Ağırlık / Weight : 10 gr/m Paket / Package: 1500 m / 15 kg</p>			<p><b>19.01.13</b></p> <p>STOPER STOP</p> <p>Malzeme / Material : EPDM</p>	
	<p><b>01.24.03</b></p> <p>KENET FİTİLİ CONNECTION GASKET</p> <p>Malzeme / Material : EPDM Ağırlık / Weight : 27 gr/m Paket / Package: 555 m / 15 kg</p>				

	<b>04.02.09</b> TAHLİYE KAPAĞI DRAINAGE COVER Malzeme / Material : PVC			<b>04.10.35 A</b> PVC KAPAK PVC CAP Malzeme / Material : PVC <small>RS83V01-RS83V02 İÇİN FOR RS83V01-RS83V02</small>	
	<b>04.07.19</b> KÖŞE ÇAVUŞU CORNER CLEAT Malzeme / Material : PVC			<b>04.10.35 B</b> PVC KAPAK (SAĞ) PVC CAP (RIGHT) Malzeme / Material : PVC <small>RS83V01-RS83V02 İÇİN FOR RS83V01-RS83V02</small>	
	<b>04.10.32 A</b> PVC KAPAK (SOL) PVC CAP (LEFT) Malzeme / Material : PVC <small>RS83V03 İÇİN / FOR RS83V03</small>			<b>04.10.36 A</b> PVC KAPAK (SAĞ) PVC CAP (RIGHT) Malzeme / Material : PVC <small>RS83V02 / RS83V05 İÇİN FOR RS83V02 / RS83V05</small>	
	<b>04.10.32 B</b> PVC KAPAK (SAĞ) PVC CAP (RIGHT) Malzeme / Material : PVC <small>RS83V03 İÇİN / FOR RS83V03</small>			<b>04.10.36 B</b> PVC KAPAK (SOL) PVC CAP (LEFT) Malzeme / Material : PVC <small>RS83V02 / RS83V05 İÇİN FOR RS83V02 / RS83V05</small>	
	<b>04.10.33 A</b> PVC KAPAK (SOL) PVC CAP (LEFT) Malzeme / Material : PVC <small>RS83V05-RS83V06 İÇİN FOR RS83V05-RS83V06</small>			<b>04.11.09</b> ALT-ÜST SEVİYE TAKOZU LOWER-TOP SUPPORT LEVEL Malzeme / Material : PVC	
	<b>04.10.33 B</b> PVC KAPAK (SAĞ) PVC CAP (RIGHT) Malzeme / Material : PVC <small>RS83V05-RS83V06 İÇİN FOR RS83V05-RS83V06</small>			<b>02.03.18</b> SİNEKLİK ADAPTÖRÜ INSECT SCREEN ADAPTER Malzeme / Material : Pvc	
	<b>04.10.34</b> PVC KAPAK PVC CAP Malzeme / Material : PVC			<b>02.03.32</b> SÜRME KANAT İSPANYOLET ADAPTÖRÜ SLIDING VENT HANDLE ADAPTER Malzeme / Material : PVC	

 <p><b>07.05.28</b> RESCARA GLOBAL PENCERE KOLU (TEK DİLLİ) RESCARA GLOBAL HANDLE FOR WINDOWS (SINGLE RAIL) Renk / Colour : Siyah-Beyaz-Gri / Black-White-Grey</p> <p>EN 1670</p>	 <p><b>07.05.25</b> GIESSE İSPANYOLET KOL (ÇİFT DİLLİ) GIESSE HANDLE FOR WINDOWS (DOUBLE RAIL) Renk / Colour : Siyah-Beyaz-Gri / Black-White-Grey</p> <p>UNI CEI EN ISO / IEC 17050</p>
 <p><b>07.05.32</b> RESCARA GLOBAL PENCERE KOLU (ÇİFT DİLLİ) RESCARA GLOBAL HANDLE FOR WINDOWS (DOUBLE RAIL) Renk / Colour : Siyah-Beyaz-Gri / Black-White-Grey</p> <p>EN 1670, 13126-8</p>	 <p><b>07.25.01</b> GIESSE T1J BAĞLANTI PARÇASI GIESSE CONNECTION ROD Renk / Colour : Siyah / Black Malzeme / Material : Polyamid / Polyamide</p> <p>07.05.25 Kol için / For Handle 07.05.25</p>
 <p><b>07.13.08</b> RESCARA KOL BAĞLANTI PARÇASI RESCARA CONNECTION PART FOR HANDLE Malzeme / Material : PVC</p> <p>07.05.32 Kol için / For Handle 07.05.32</p>	 <p><b>07.13.07</b> KOL BAĞLANTI PARÇASI CONNECTION PART FOR HANDLE Malzeme / Material : Zamak / Zamak</p> <p>07.05.28 Kol için / For Handle 07.05.28</p>
 <p><b>16.05.07</b> KİLİT ADAPTÖRÜ LOCK ADAPTER</p> <p>07.05.25, 07.05.28 ve 07.05.32 Kolları için / For Handles 07.05.25, 07.05.28 and 07.05.32</p>	 <p><b>16.05.02</b> SÜRME KİLİT KARŞILIĞI STRIKER FOR SLIDING LOCK</p> <p>07.05.25, 07.05.28 ve 07.05.32 Kolları için / For Handles 07.05.25, 07.05.28 and 07.05.32</p>
 <p><b>16.04.04</b> SÜRME DİL SLIDING BOLT</p> <p>07.05.25, 07.05.28 ve 07.05.32 Kolları için / For Handle 07.05.25, 07.05.28 and 07.05.32</p>	

KOL İLE KİLİTLEME SEÇİM TABLOSU  
LOCKING KIT SELECTION TABLE WITH HANDLE

KOD CODE	TANIM DESCRIPTION	ADET NUMBER				KANAT VENT	
		H: 0-1200 mm	H: 1201-1799 mm	H: 1800-2199mm	H: 2200-2500 mm		
RESCARA TEK DİLLİ KOL RESCARA SINGLE RAIL HANDLE	07.05.28	RESCARA GLOBAL PENCERE KOLU RESCARA GLOBAL HANDLE	1	1	1	1	RS83V03
	07.13.07	KOL BAĞLANTI PARÇASI CONNECTION PART FOR HANDLE	1	1	1	1	
GIESSE ÇİFT DİLLİ KOL GIESSE DOUBLE RAIL HANDLE	07.05.25	GIESSE İSPANYOLET KOL GIESSE HANDLE FOR WINDOWS	1	1	1	1	
	07.25.01	GIESSE TIJ BAĞLANTI PARÇASI GIESSE CONNECTION ROD	1	1	1	1	
RESCARA ÇİFT DİLLİ KOL RESCARA DOUBLE RAIL HANDLE	07.05.32	RESCARA GLOBAL PENCERE KOLU RESCARA GLOBAL HANDLE	1	1	1	1	
	07.13.08	RESCARA KOL BAĞLANTI PARÇASI RESCARA CONNECTION ROD	1	1	1	1	
16.05.07	KİLİT ADAPTÖRÜ LOCK ADAPTER	2	3	4	5		
16.04.04	SÜRME DİL SLIDING BOLT	2	3	4	5		
16.05.02	SÜRME KİLİT KARŞILIĞI STRIKER FOR SLIDING LOCK	2	3	4	5		

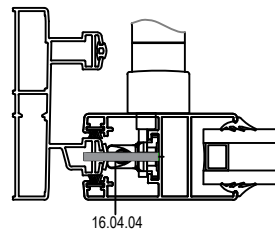
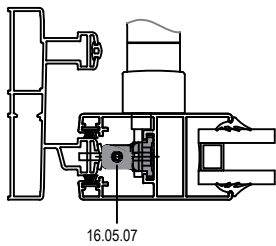
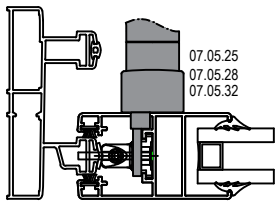



07.10.12

HAVUZLU KİLİT ANAHTARLI  
SLIDING LOCK WITH KEY

Malzeme / Material : Alüminyum- Zamak  
Aluminium -Zamak



07.10.13

HAVUZLU KİLİT  
SLIDING LOCK

Malzeme / Material : Alüminyum- Zamak  
Aluminium -Zamak



07.10.14

ÇİFTLİ HAVUZLU KİLİT ANAHTARLI  
DOUBLE SLIDING LOCK WITH KEY

Malzeme / Material : Alüminyum- Zamak  
Aluminium -Zamak



07.10.09

HAVUZ KOL  
SLIDING HANDLE

Malzeme / Material : Alüminyum- Zamak  
Aluminium -Zamak

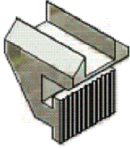

07.11.03

KOL ÜSTÜ KARŞILIK  
STRIKER FOR HANDLE

07.10.12 , 07.10.13 , 07.10.14 Sürme Kilit için / For Handle 07.10.12 , 07.10.13 , 07.10.14



16.05.06

SÜRME KİLİT KARŞILIĞI  
STRIKER FOR SLIDING LOCK

07.10.12 , 07.10.13 , 07.10.14 Sürme Kilit için / For Handle 07.10.12 , 07.10.13 , 07.10.14

HAVUZLU KOL İLE KİLİTLEME SEÇİM TABLOSU

LOCKING KIT SELECTION TABLE WITH SLIDING LOCK

KOD CODE	TANIM DESCRIPTION	ADET NUMBER	KANAT VENT
07.10.12 07.10.13 07.10.14	HAVUZLU KİLİT SLIDING LOCK	1	RS83V01 RS83V02
16.05.06	SÜRME KİLİT KARŞILIĞI STRIKER FOR SLIDING LOCK	1	
07.11.03	KOL ÜSTÜ KARŞILIK STRIKER FOR HANDLE	1	

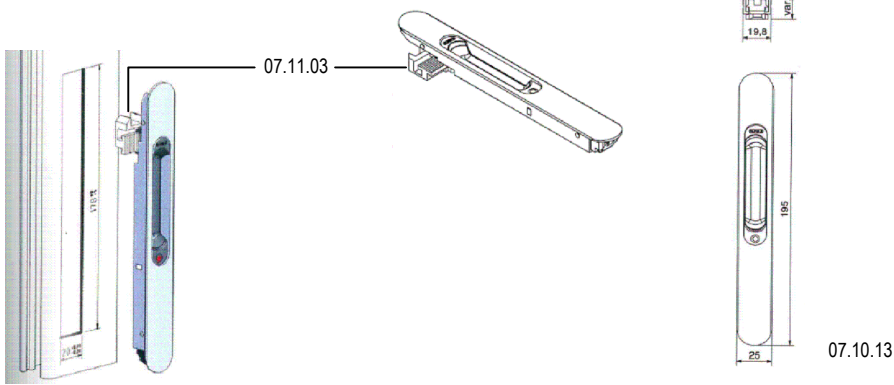
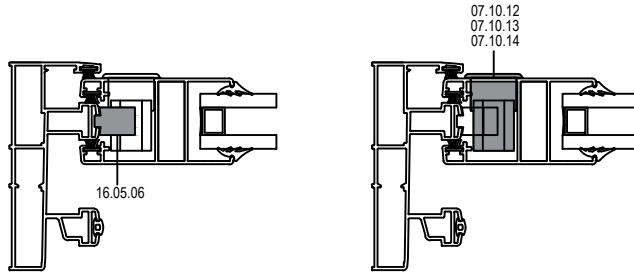



PVC KOL İLE KİLİTLEME SEÇİM TABLOSU

LOCKING KIT SELECTION TABLE WITH PVC HANDLE

KOD CODE	TANIM DESCRIPTION	ADET NUMBER	KANAT VENT
07.05.41 07.05.42 07.05.48	PVC İSPANYOLET KOL PVC HANDLE	1	RS83V01 RS83V03
16.05.08	SÜRME KİLİT KARŞILIĞI STRIKER FOR SLIDING LOCK	BKZ. 07.18.xx SEÇİM TABLOSU SEE 07.18.xx SELECTION TABLE	
04.20.03	SÜRME SAC KARŞILIĞI TIN PLATE STRIKER FOR SLIDING LOCK	BKZ. 07.18.xx SEÇİM TABLOSU SEE 07.18.xx SELECTION TABLE	
07.18.XX	SÜRME İSPANYOLETİ SLIDING ESPOGNOLETTE	1	

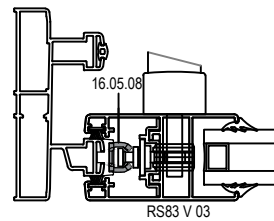
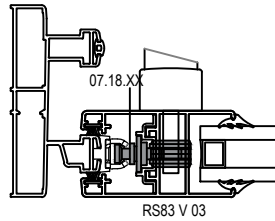
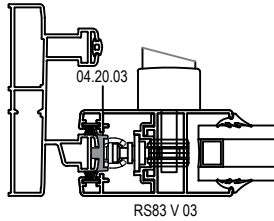
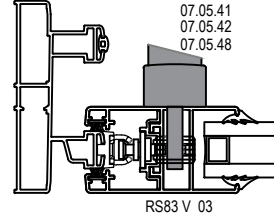

07.18.xx 15 EKSEN SÜRME İSPANYOLETİ

07.18.xx 15 AXIS STEEL GEARBOX SLIDING ESPOGNOLETTE

KOD CODE	ÖLÇÜ DIMENSION	16.05.08 ADET/NUMBER	04.20.03 ADET/NUMBER
07.18.32	h: 600mm-800 mm / 15	2	2
07.18.33	h: 800mm-1000 mm / 15	2	2
07.18.34	h: 1000mm-1200 mm / 15	3	3
07.18.35	h: 1200mm-1400 mm / 15	3	3
07.18.36	h: 1400mm-1600 mm / 15	3	3
07.18.37	h: 1600mm-1800 mm / 15	3	3
07.18.38	h: 1800mm-2000mm / 15	4	4
07.18.39	h: 2000mm-2100mm / 15	4	4

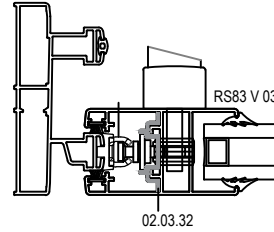

 <p><b>16.02.02</b> GIESSE AYARLI ÇİFTLİ RULMAN GIESSE ADJUSTABLE CARRERA 2 PULLEYS Malzeme / Material : Polyamid- Zamak Polyamide -Zamak</p> <p>2 Adet 180 kg taşır. / 180 kg with 2 pulleys EN 13126-15 : 2008</p>	 <p><b>16.02.07</b> RESCARA AYARLI ÇİFTLİ RULMAN RESCARA ADJUSTABLE CARRERA 2 PULLEYS</p> <p>2 Adet 120 kg taşır. / 120 kg with 2 pulleys</p>
 <p><b>16.01.01</b> AYARLI TEKLİ RULMAN PULLEY WITH SINGLE WHEEL</p> <p>2 Adet 35 kg taşır. / 35 kg with 2 pulleys Max. kanat ölçüsü 600x1500./ Max. vent dimension 600x1500</p>	 <p><b>16.01.02</b> AYARLI ÇİFTLİ RULMAN ADJUSTABLE PULLEYS</p> <p>2 Adet 65 kg taşır. / 65 kg with 2 pulleys Max. kanat ölçüsü 1000x2100./ Max. vent dimension 1000x2100</p>
 <p><b>16.01.12</b> METAL TEKERLEKLİ AYARLI RULMAN STEEL ADJUSTABLE PULLEYS</p> <p>2 Adet 65 kg taşır. / 65 kg with 2 pulleys Max. kanat ölçüsü 1000x2100./ Max. vent dimension 1000x2100</p>	 <p><b>16.01.13</b> METAL TEKERLEKLİ AYARLI RULMAN PULLEY WITH SINGLE WHEEL</p> <p>2 Adet 35 kg taşır. / 35 kg with 2 pulleys Max. kanat ölçüsü 600x1500./ Max. vent dimension 600x1500</p>
 <p><b>16.02.06</b> SİNEKLİK RULMANI SWATTER PULLEYS</p>	 <p><b>16.06.06</b> ÇELİK RAY STEEL RAIL Malzeme / Material : Paslanmaz Çelik Stainless Steel</p>
 <p><b>21.01.08</b> PUNCH MAKİNESİ PUNCH MACHINE Pnömatik</p>	

**MİMARİ KATALOG**  
ARCHITECTURAL CATALOGUE

**Alüminyum Sürme Sistemleri**  
Aluminium Sliding Systems

# RS83

**İMALAT DETAYLARI**

**FABRICATION DETAILS**

( 1 ) KASA KÖŞE BAĞLANTI DETAYI  
FRAME CORNER DETAIL

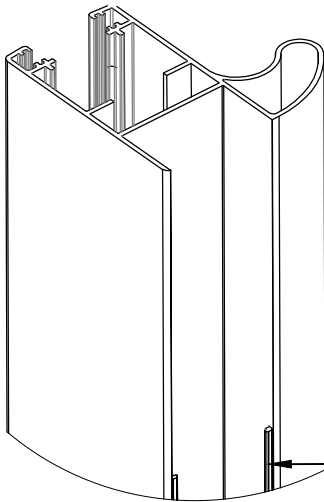
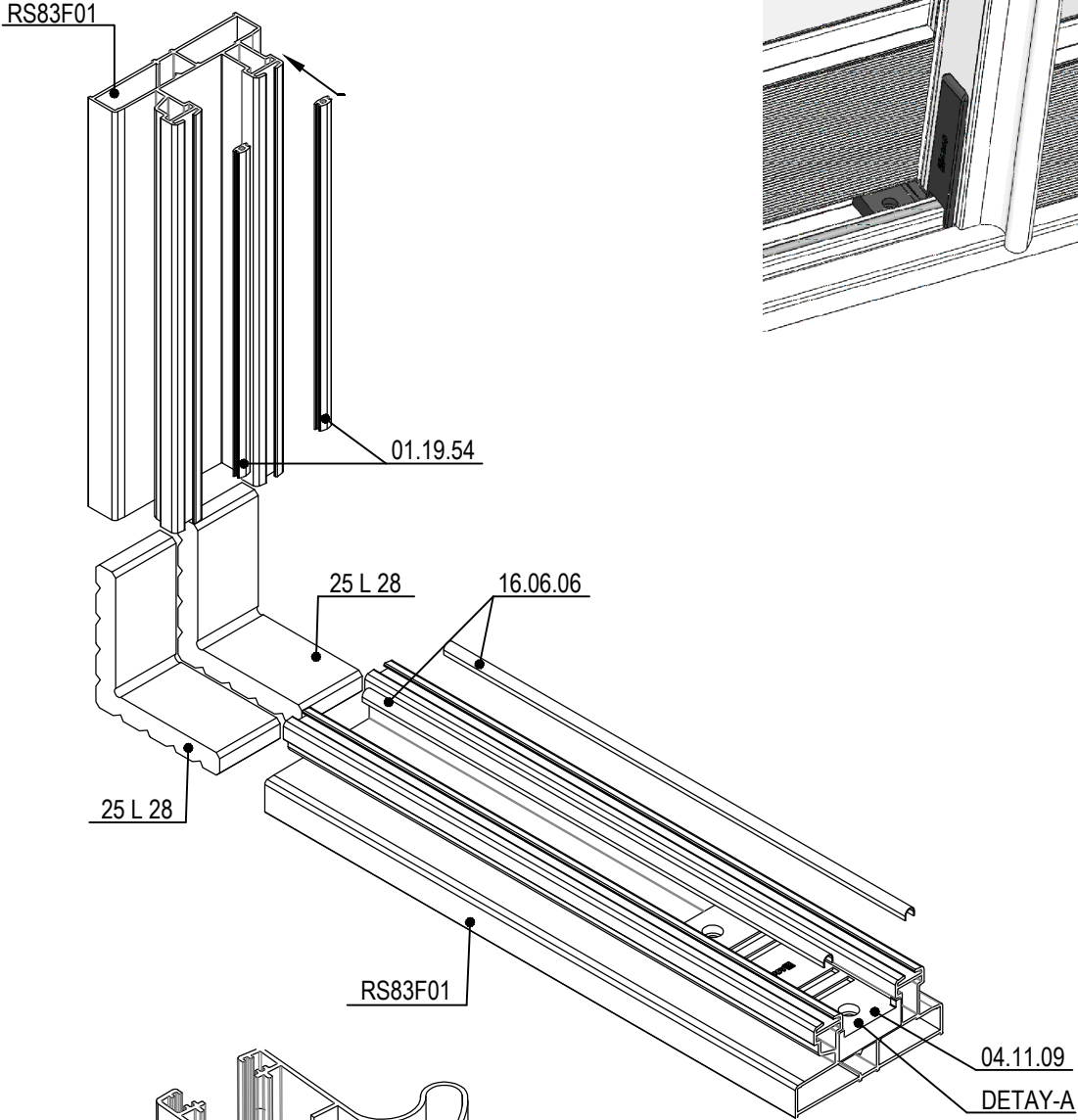

21.01.08 Punch Makinesinin kalıplarına göre kertilcektir.  
Will be notched according to the punch machine 21.01.08

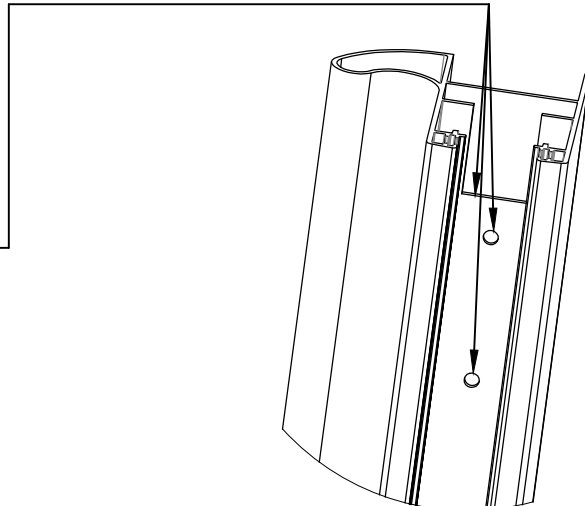

(2) DÜŞEY - YATAY KANAT BAĞLANTI DETAYI (ÜST)  
VERTICAL & HORIZONTAL VENT CONNECTION DETAIL (UPPER)

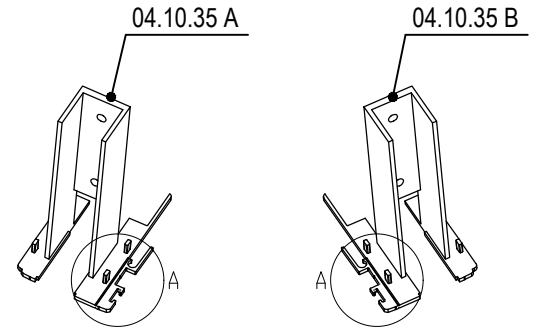
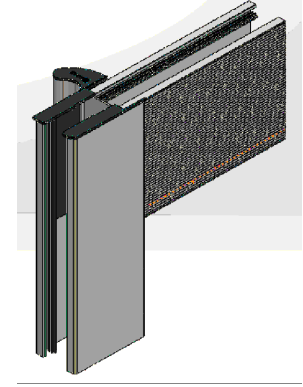
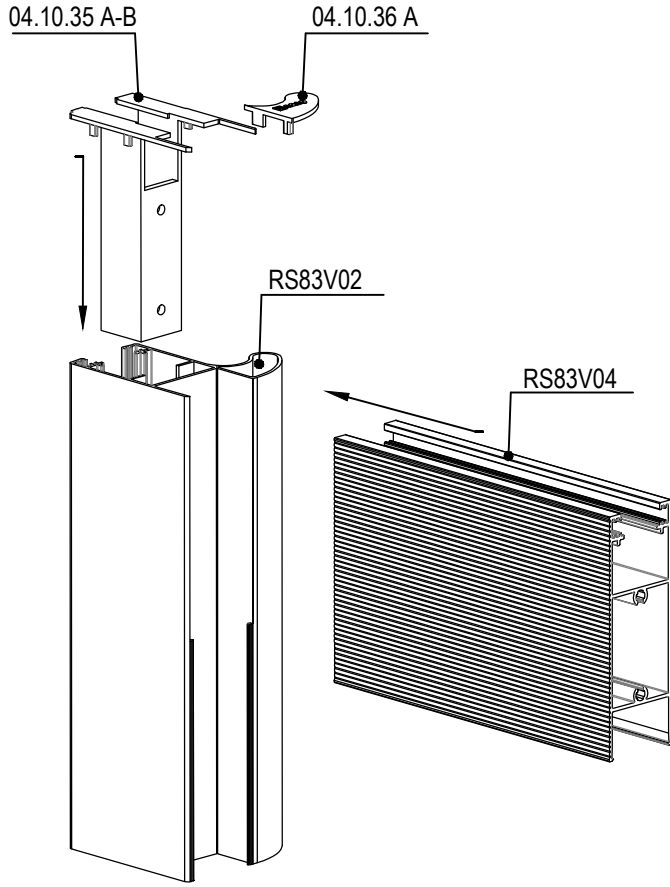

(3) DÜŞEY - YATAY KANAT BAĞLANTI DETAYI (ALT)  
VERTICAL & HORIZONTAL VENT CONNECTION DETAIL (BOTTOM)

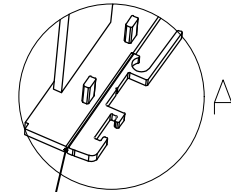
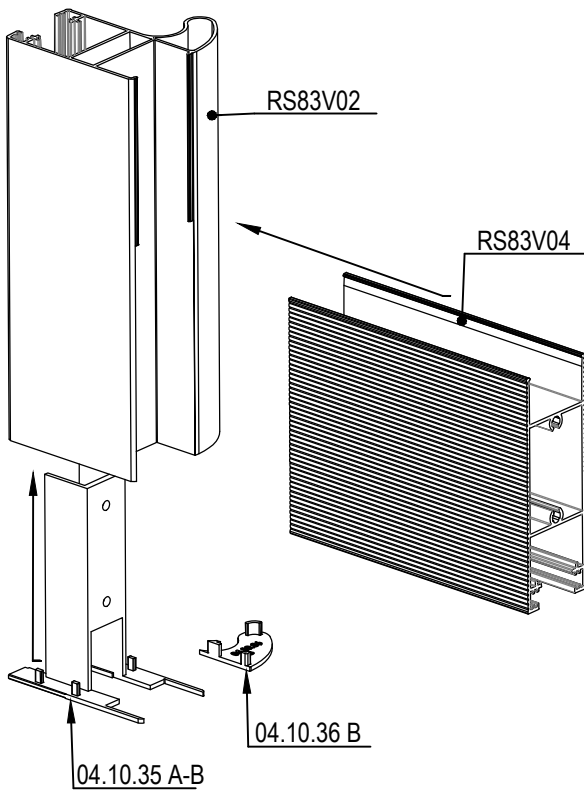

\*Detayda gösterilen yerden koparılacaktır.

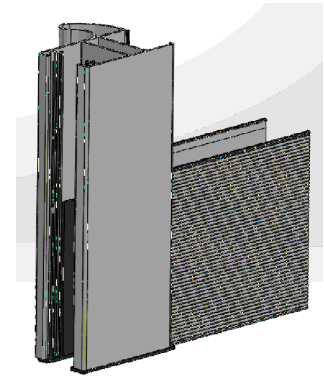



( 5 ) ORTA KAYIT BAĞLANTI DETAYI (ALT)  
MULLION CONNECTION DETAIL (BOTTOM)

