

MİMARİ KATALOG
ARCHITECTURAL CATALOGUE

Alüminyum Kapı ve Pencere Sistemleri
Aluminium Door and Window Systems

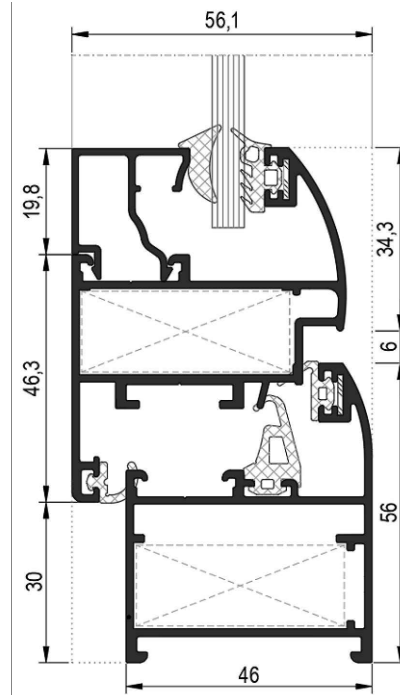

RW46



TEKNİK ÖZELLİKLERİ / TECHNICAL PROPERTIES

KASA DERİNLİĞİ / FRAME DEPTH	46 mm
KANAT DERİNLİĞİ / VENT DEPTH	51,6 / 46 / 51,2 mm
PROFİL ET KALINLIĞI / PROFILE WALL THICKNESS	1,4 mm
MAKS. CAM KALINLIĞI / MAX. GLASS THICKNESS	22 mm

KULLANIM SEÇENEKLERİ / APPLICATION ALTERNATIVES

	KAPI DOOR	PENCERE WINDOW
İÇE AÇILIR / INWARD OPENING	•	•
DIŞA AÇILIR BİNİLİ KAPI / OUTWARD OPENING DOOR	•	
VASİSTAS / BOTTOM HUNG		•
DIŞA - İÇE AÇILIR HEMYÜZ KAPI / OUTWARD-INWARD OPENING COPLANAR DOOR	•	
ÇİFT EKSEN AÇILIM / TILT&TURN OPENING	•	•
PVC AKSESUAR İÇİN KANAT / VENT FOR PVC ACCESSORIES	•	•

MİMARİ KATALOG
ARCHITECTURAL CATALOGUE

Alüminyum Kapı ve Pencere Sistemleri
Aluminium Door and Window Systems



RW46

PROFİLLER

PROFILES

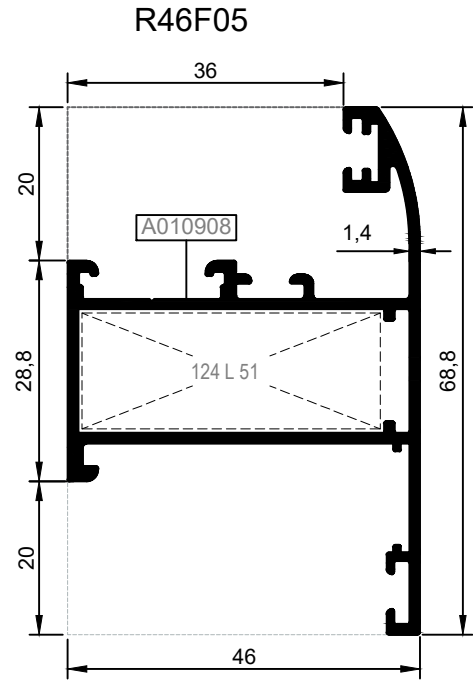
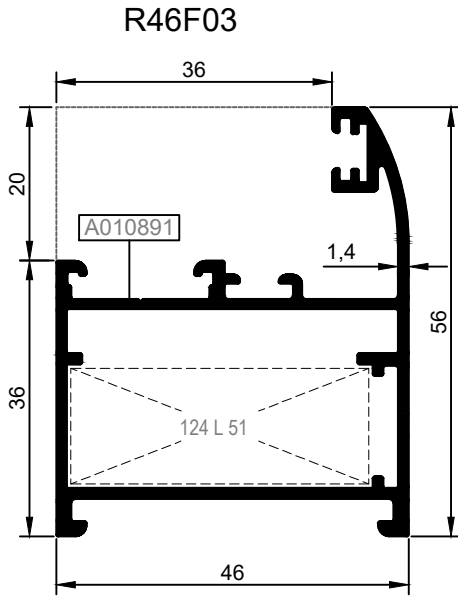
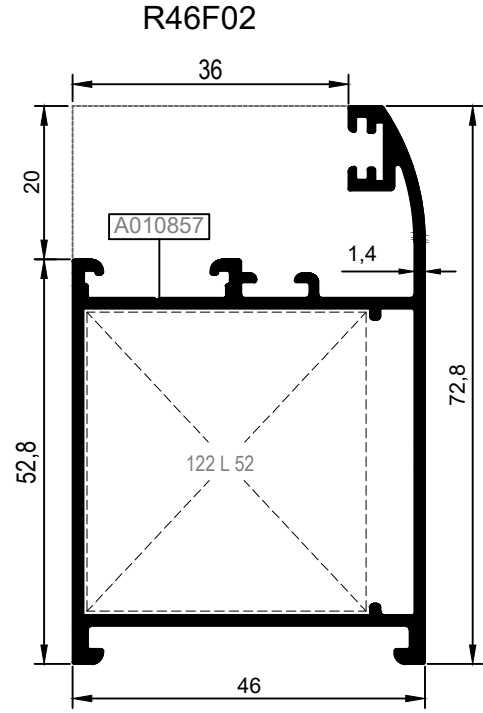
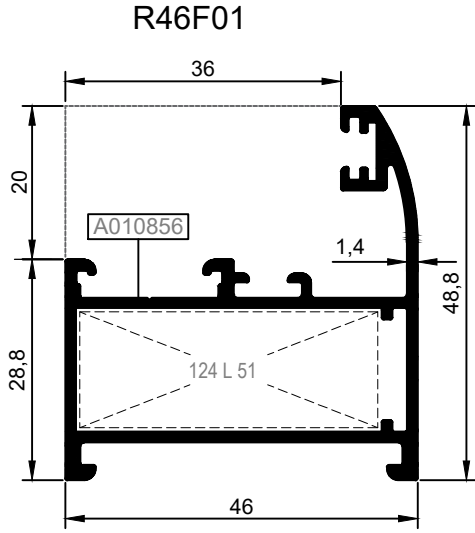
KOD / CODE	AĞIRLIK (kg/m) / WEIGHT	Jxx cm4	Jyy cm4	L m	
R46F01	0,827	8,567	5,466	6	
R46F02	1,003	11,918	18,075	6	
R46F03	0,907	9,939	8,264	6	
R46F05	0,915	9,556	8,853	6	



Nr		 L m	KESİM ÖLÇÜSÜ CUTTING SIZE	 AKS. KODU ACS. CODE
R46F01	A010856	25L51 (A010887)	39,3 mm	124 L 51
R46F03	A010891			
R46F05	A010908			
R46F02	A010857	25L52 (A010888)	36,7 mm	122 L 52

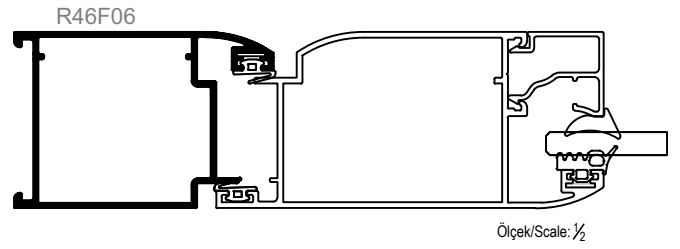
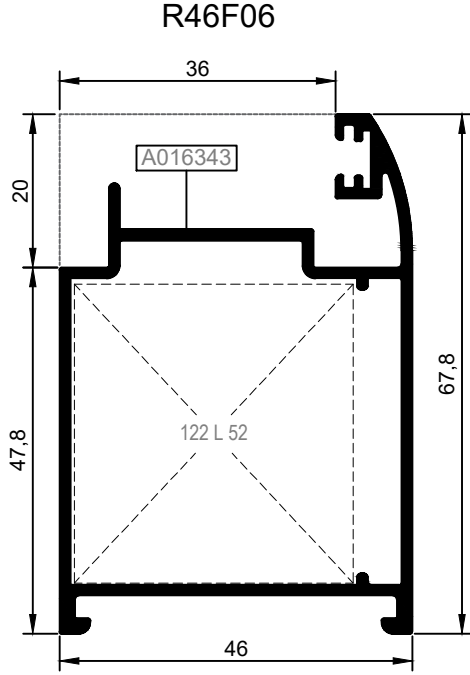
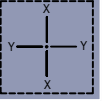

KOD / CODE	AĞIRLIK (kg/m) / WEIGHT	Jxx cm ⁴	Jyy cm ⁴	L m	
R46F06	0,96	11,436	16,619	6	

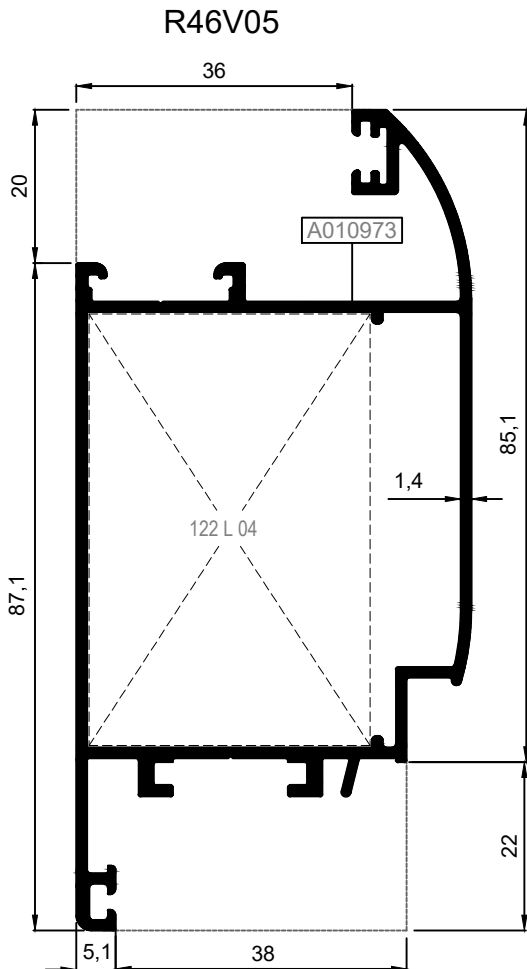
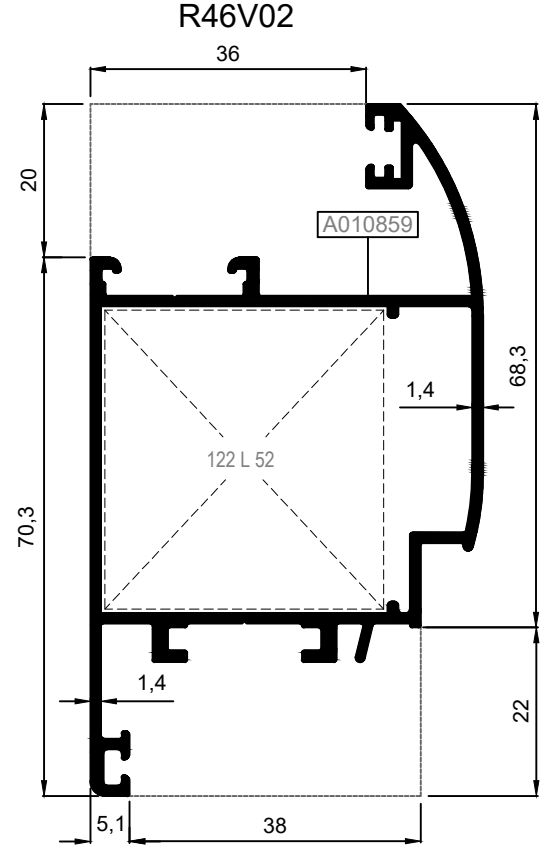
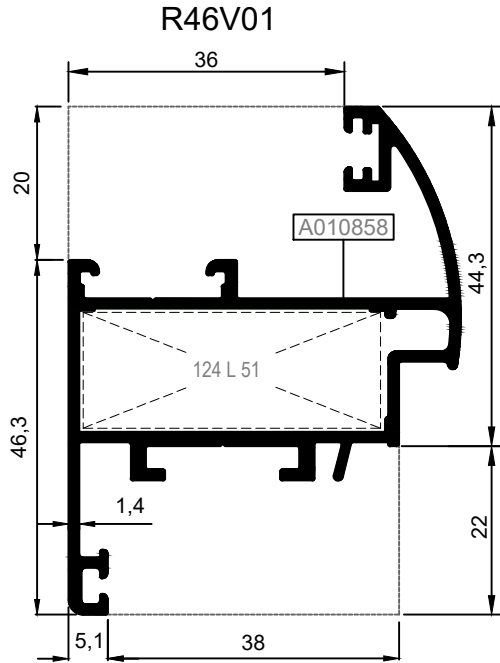

Nr		L m	KESİM ÖLÇÜSÜ CUTTING SIZE	AKS. KODU ACS. CODE
R46F06	A016343	25L52 (A010888)	36,7 mm	122 L 52

KOD / CODE	AĞIRLIK (kg/m) / WEIGHT	Jxx cm ⁴	Jyy cm ⁴	L m	
R46V01	1,011	11,784	9,210	6	
R46V02	1,190	15,911	26,522	6	
R46V05	1,316	19,099	46,318	6	



Nr		 L m	KESİM ÖLÇÜSÜ CUTTING SIZE	 AKS. KODU ACS. CODE
R46V01	A010858	25L51 (A010887)	39,3 mm	124 L 51
R46V02	A010859	25L52 (A010888)	36,7 mm	122 L 52
R46V05	A010973	25L04 (A002211)	36,7 mm	122 L 04

KOD / CODE	AĞIRLIK (kg/m) / WEIGHT	Jxx cm ⁴	Jyy cm ⁴	L m	
R46V03	1,204	15,071	37,926	6	
R46V04	1,205	14,263	37,934	6	

R46V03

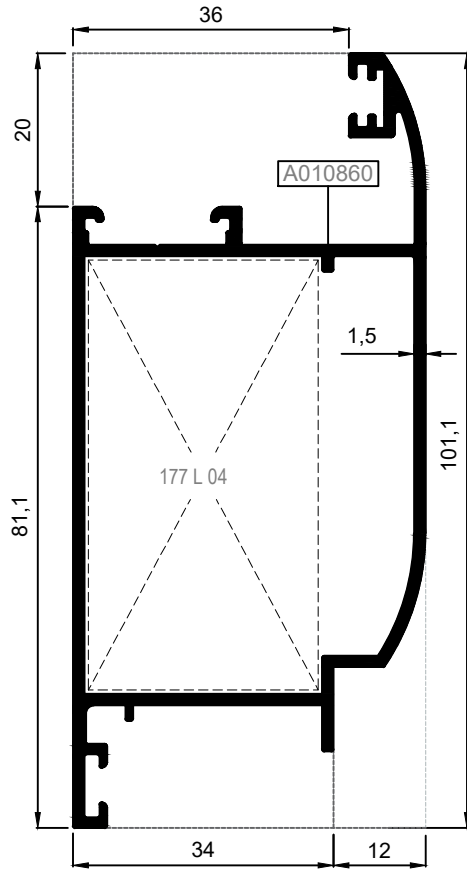

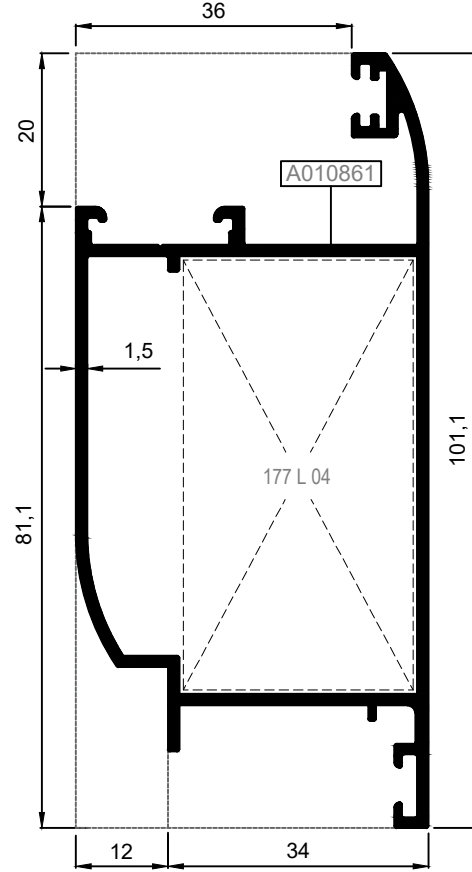

İÇE AÇILIM HEMYÜZ KAPI KANAT PROFİLİ
INWARD OPENING FLUSH DOOR VENT PROFILE

R46V04



DIŞA AÇILIM HEMYÜZ KAPI KANAT PROFİLİ
OUTWARD OPENING FLUSH DOOR VENT PROFILE



Nr		 L m	KESİM ÖLÇÜSÜ CUTTING SIZE	 AKS. KODU ACS. CODE
R46V03	A010860	25L04 (A002211)	30,7 mm	177 L 04
R46V04	A010861	25L04 (A002211)	30,7 mm	177 L 04

KANAT VE ADAPTÖR PROFİLLERİ (PVC AKSESUARA UYGUN - 9 AKS)
VENT AND ADAPTER PROFILES (FOR PVC ACCESSORY - 9 AXLE)

RW46

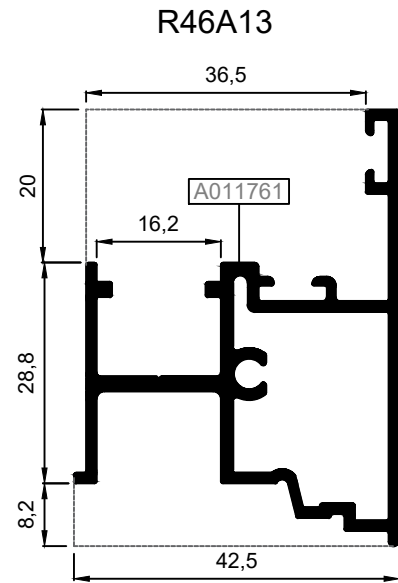
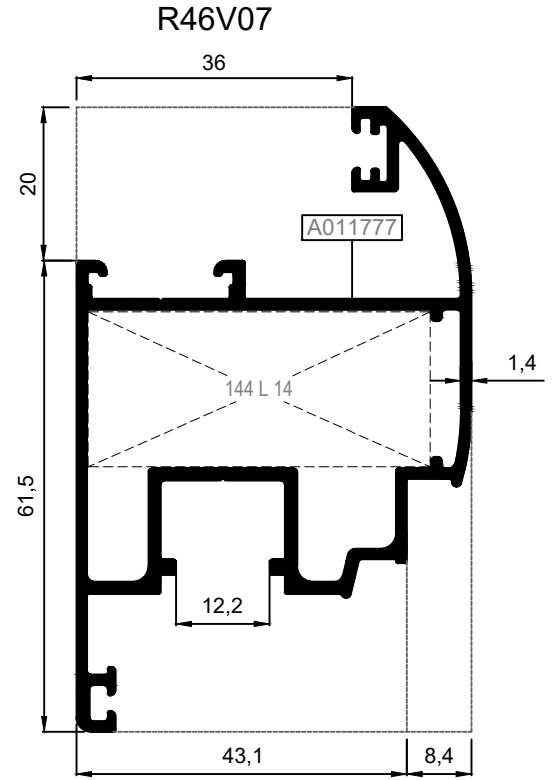
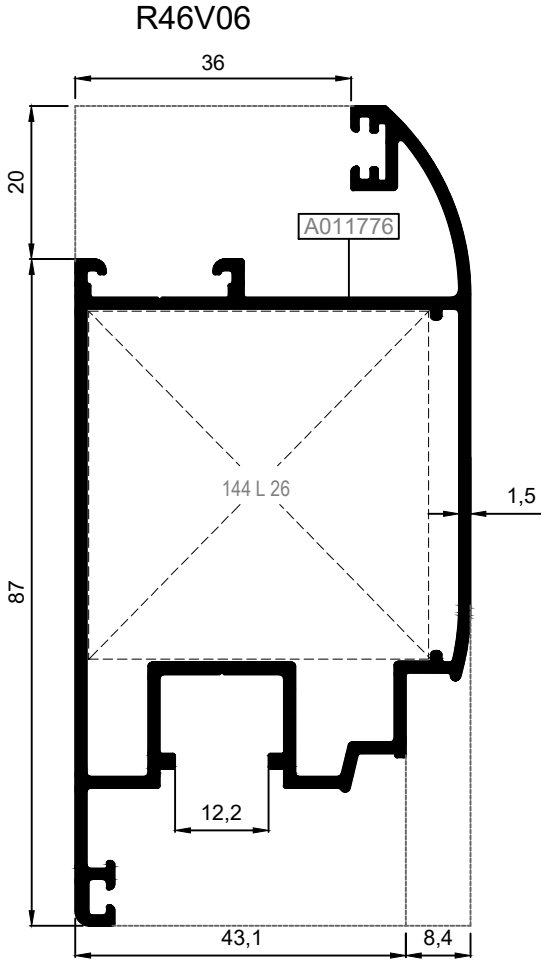
KOD / CODE	AĞIRLIK (kg/m) / WEIGHT	Jxx cm ⁴	Jyy cm ⁴	L m	
R46V06	1,447	20,380	47,892	6	
R46V07	1,216	15,045	19,019	6	
R46A13	0,856	----	----	6	



Nr		 L m	KESİM ÖLÇÜSÜ CUTTING SIZE	 AKS. KODU ACS. CODE
R46V06	A011776	25L26 (A010540)	44,4 mm	144 L 26
R46V07	A011777	25L14 (A002059)	44,4 mm	144 L 14

KOD / CODE	AĞIRLIK (kg/m) / WEIGHT	Jxx cm ⁴	Jyy cm ⁴	L m	
R46M01	0,975	7,752	8,326	6	
R46M02	1,129	9,957	21,354	6	
R46M03	1,019	9,293	20,294	6	

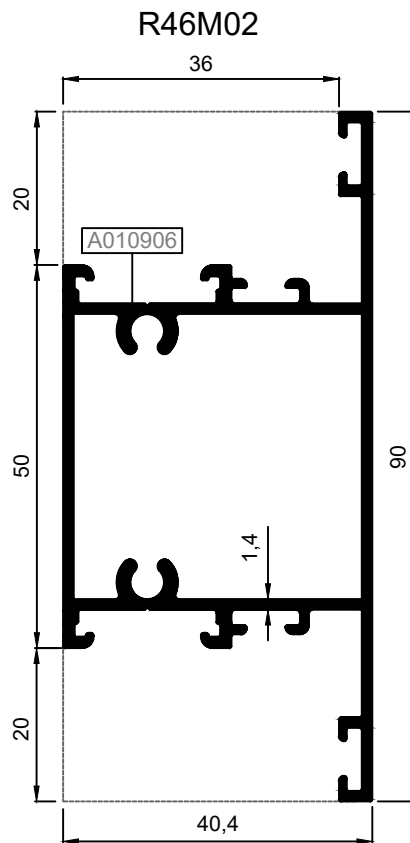
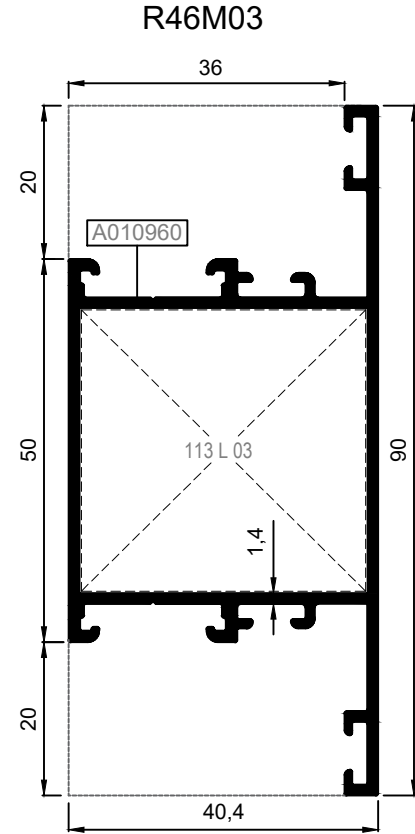
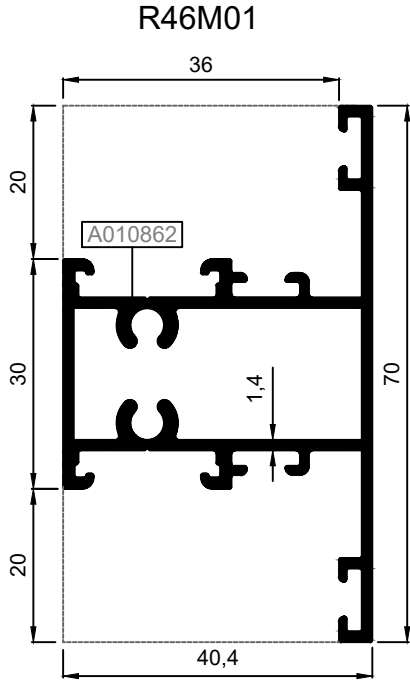

Nr		L m	KESİM ÖLÇÜSÜ CUTTING SIZE	AKS. KODU ACS. CODE
R46M03	A010960	25L03 (A002021)	37,1 mm	113 L 03
Nr		L m	KESİM ÖLÇÜSÜ CUTTING SIZE	AKS. KODU ACS. CODE
R46M03	A010960	25J13 (A010959)	36,9 mm	307 J 13

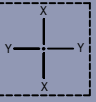
KOD / CODE	AĞIRLIK (kg/m) / WEIGHT	Jxx cm ⁴	Jyy cm ⁴	L m	
R46K01	1,353	14,122	65,435	6	
R46A02	0,825	5,978	7,242	6	
R46A03	0,473	----	----	6	
25I07	0,143	----	----	6	
25I04	0,153	----	----	6	

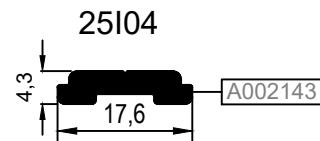
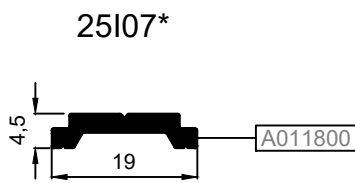
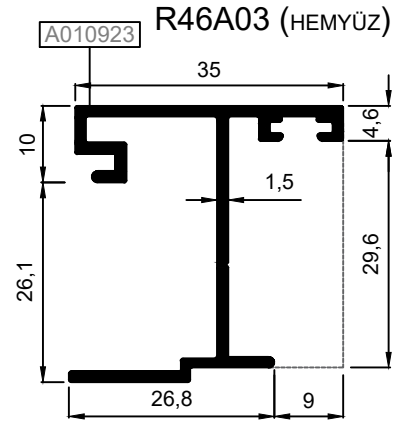
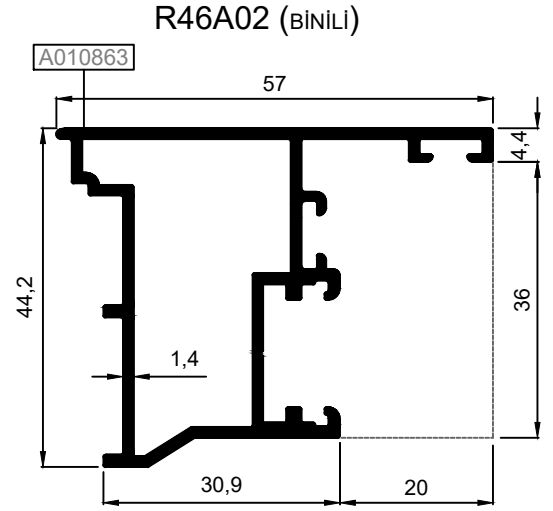
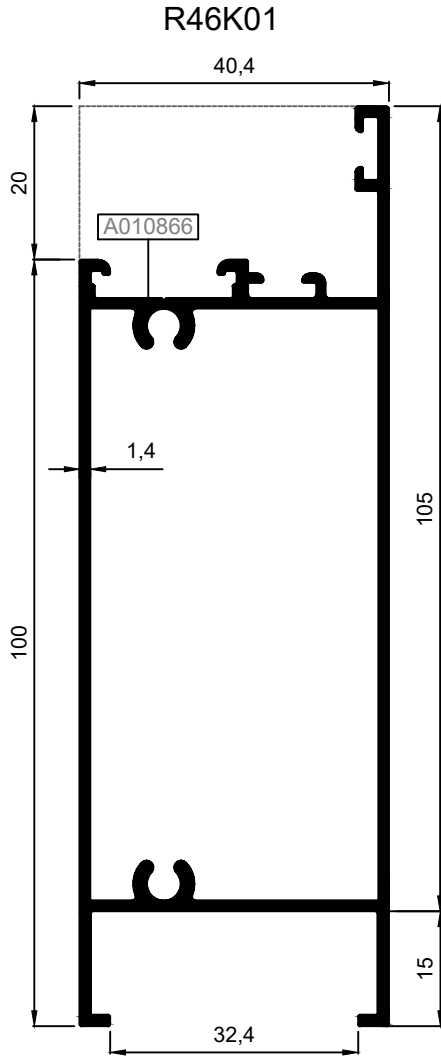

***Giesse kol ve kilitleme aksesuarları sadece 25I07 tij profili ile kullanılmalıdır.
Giesse handle and locking accessories should be used with only 25I07 rod profile

KOD / CODE	AĞIRLIK (kg/m) / WEIGHT	Jxx cm ⁴	Jyy cm ⁴	L m	
R46A04	0,230	----	----	6	
R46A07	0,475	----	----	6	
R46A12	0,686	----	----	6	

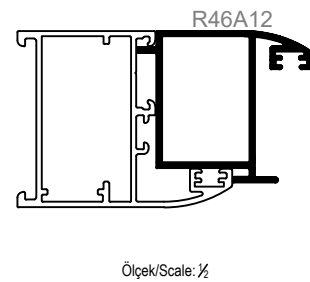
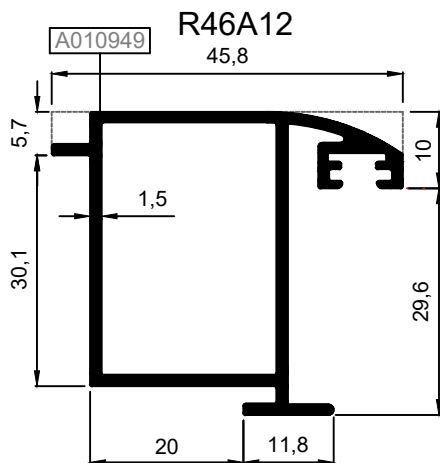
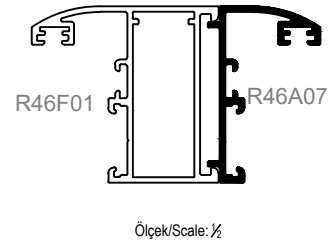
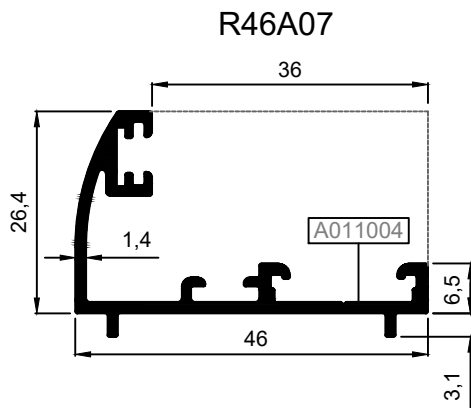
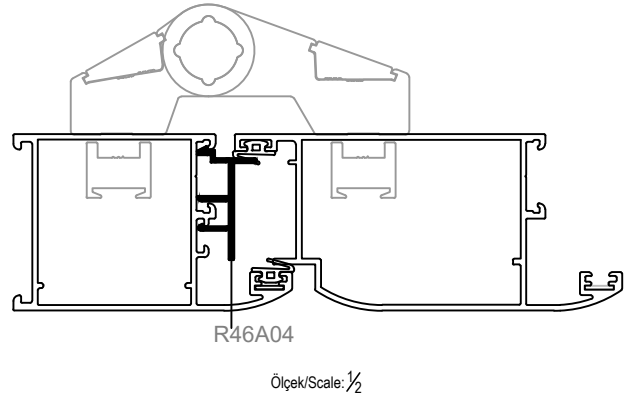
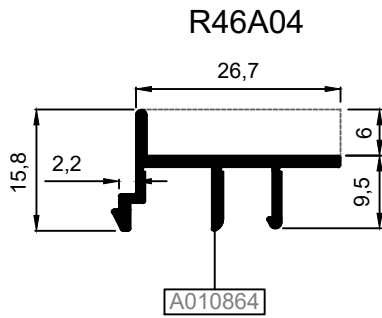

KOD / CODE	AĞIRLIK (kg/m) / WEIGHT	Jxx cm ⁴	Jyy cm ⁴	L m	
R46A09	0,417	----	----	6	
A001185	0,556	----	----	6	
46D01	0,902	----	----	6	

R46A09

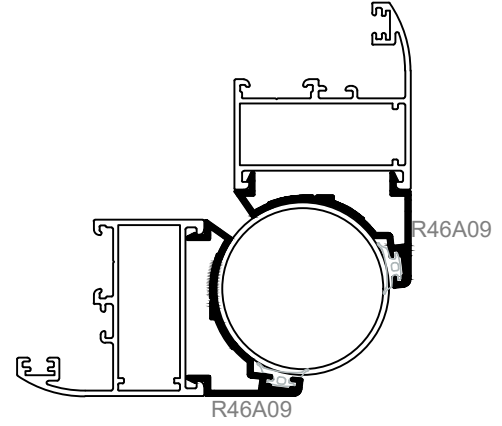
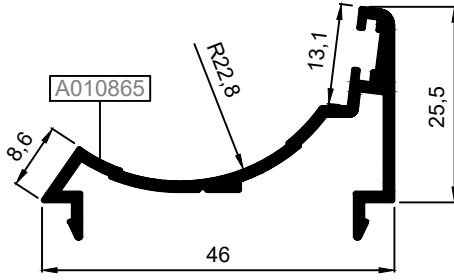

Ölçek/Scale: 1:1

A001185

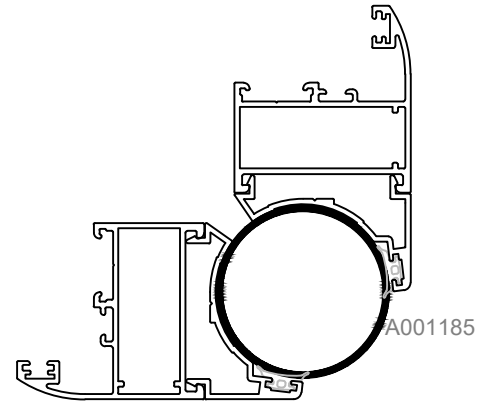
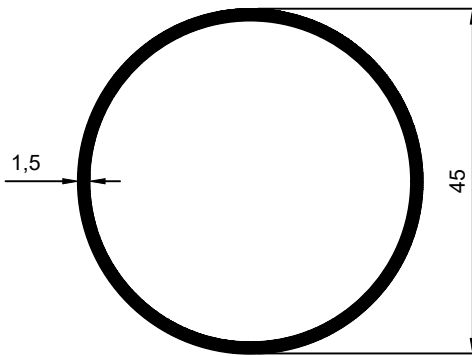

Ölçek/Scale: 1:1

46D01

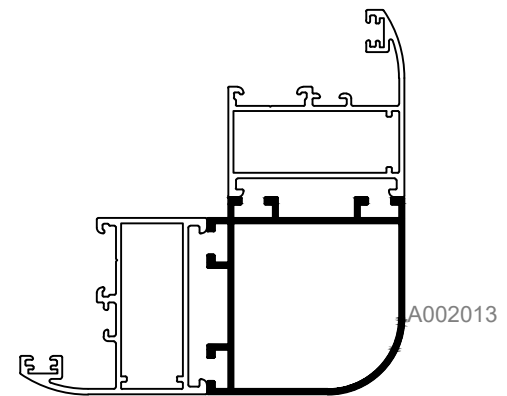
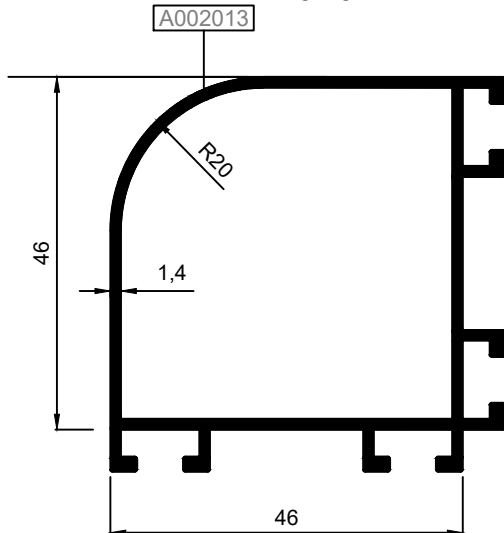

Ölçek/Scale: 1:1

KOD / CODE	AĞIRLIK (kg/m) / WEIGHT	Jxx cm ⁴	Jyy cm ⁴	L m	
46D02	0,794	----	----	6	
46A10	0,398	----	----	6	
46A08	0,354	----	----	6	

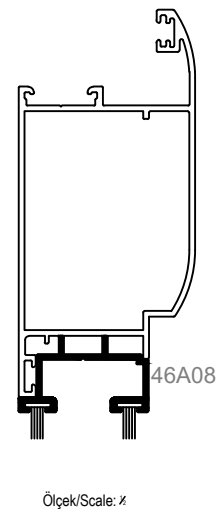
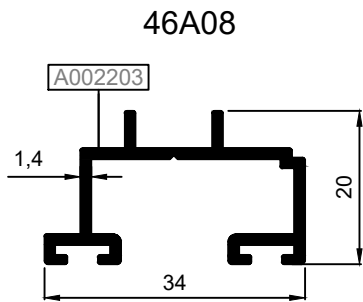
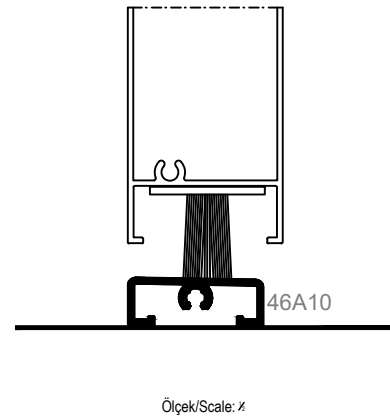
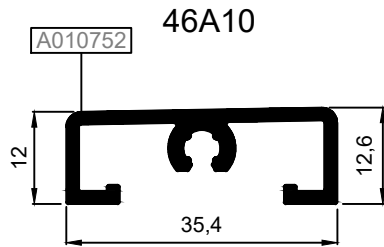
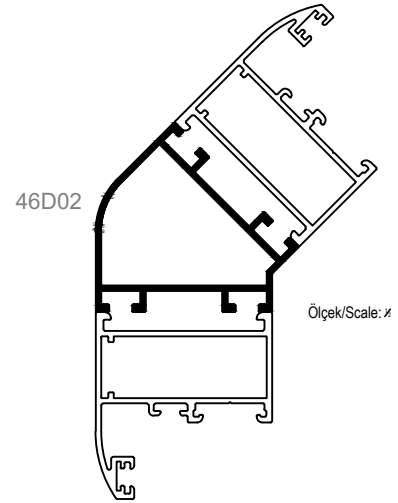
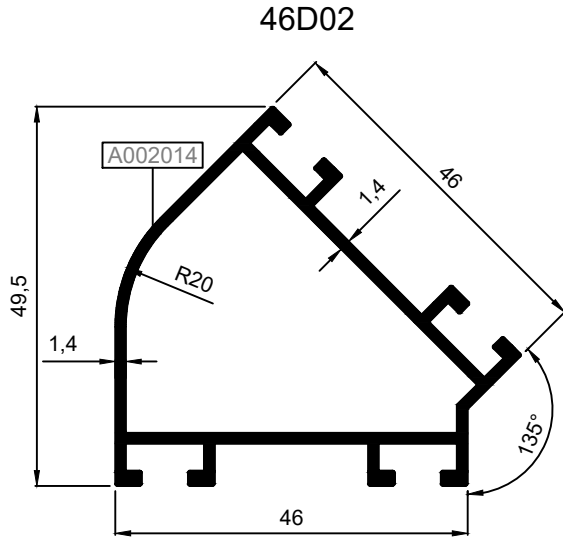

KOD / CODE	AĞIRLIK (kg/m) / WEIGHT	L m	KOD / CODE	AĞIRLIK (kg/m) / WEIGHT	L m
25G21	0,196	6	25G12	0,270	6
25G37	0,206	6	25G13	0,278	6
25G11	0,224	6	25G14	0,281	6
25G10	0,226	6	25G15	0,285	6
25G09	0,229	6			

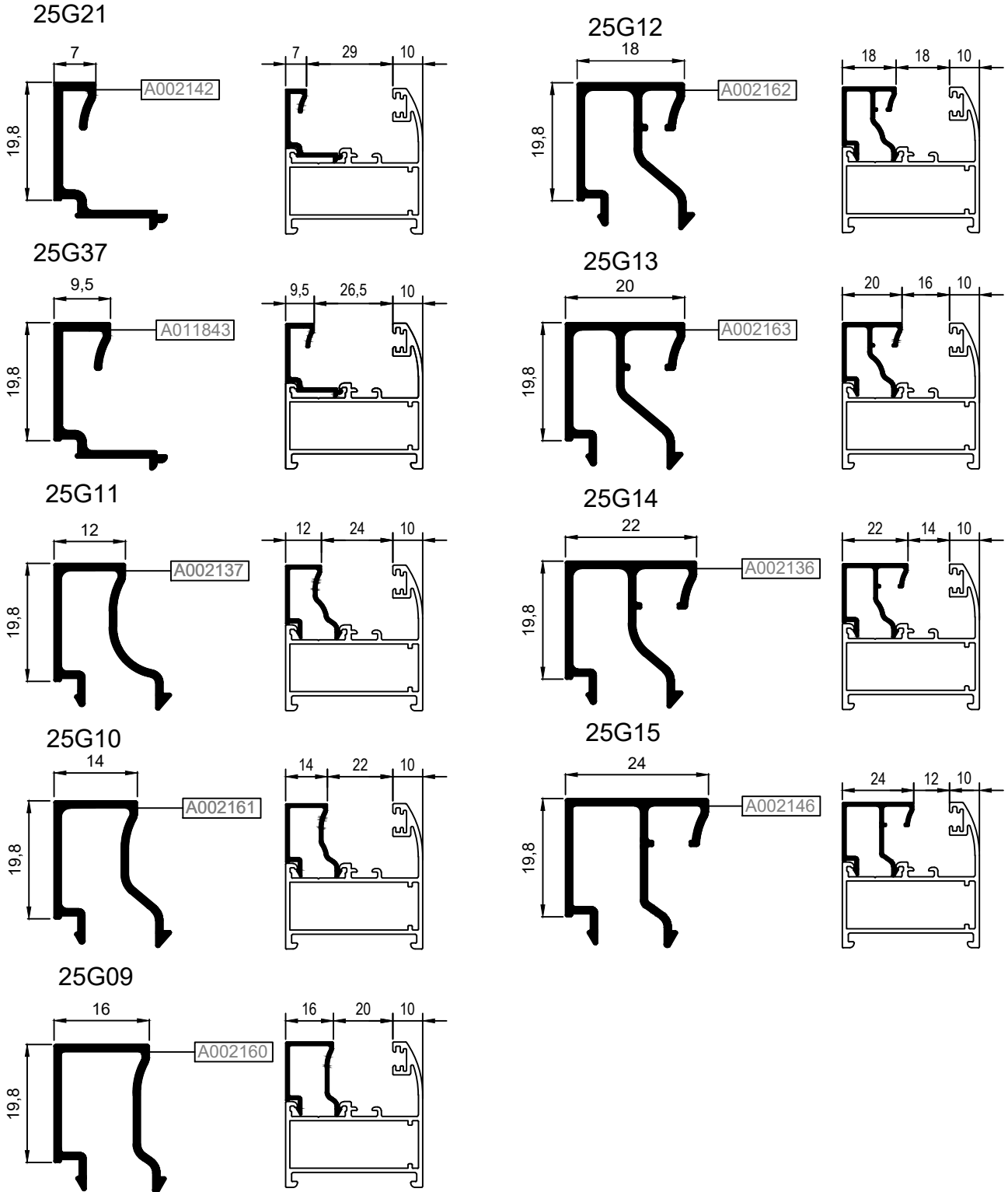
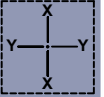

B, CAM ÇITASI GLAZING BEAD	C, İÇ CAM FİTİLİ GLASS GASKET (IN)	A, CAM KALINLIĞI GLASS THICKNESS	D, DIŞ CAM FİTİLİ GLASS GASKET (OUT)
25G15	01.17.04	4 mm	01.11.15
25G15	01.17.03	5 mm	01.11.15
25G14	01.17.04	6 mm	01.11.15
25G14	01.17.03	7 mm	01.11.15
25G13	01.17.04	8 mm	01.11.15
25G13	01.17.03	9 mm	01.11.15
25G12	01.17.04	10 mm	01.11.15
25G12	01.17.03	11 mm	01.11.15
25G09	01.17.04	12 mm	01.11.15
25G09	01.17.03	13 mm	01.11.15
25G10	01.17.04	14 mm	01.11.15
25G10	01.17.03	15 mm	01.11.15
25G11	01.17.04	16 mm	01.11.15
25G11	01.17.03	17 mm	01.11.15
25G37	01.17.05	18 mm	01.11.15
25G37	01.17.04	19 mm	01.11.15
25G21	01.17.05	20 mm	01.11.15
25G21	01.17.04	21 mm	01.11.15
25G21	01.17.03	22 mm	01.11.15

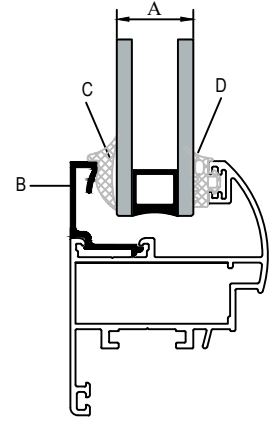
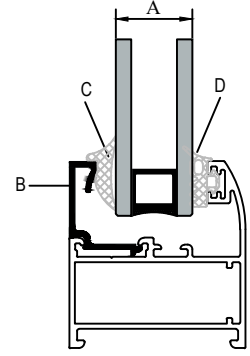

CAM MONTAJINDA SADECE BU SİSTEM İÇİN TASARLANAN VE ÜRETİLEN FİTİLLER KULLANILMALIDIR. FARKLI MALZEME KULLANIMLARI İŞLEVSEL VE TASARIMSAL SORUNLARA SEBEP OLABİLİR. THE GASKETS USED DURING INSTALLING THE GLASS SHOULD BE ONLY THE ONES CREATED FOR THIS SYSTEM. THE USE OF OTHER MATERIALS MAY CAUSE FUNCTIONAL AND DESIGN PROBLEMS.

TABLODA VERİLEN CAM KALINLIKLARI TEORİK OLUP SİSTEMİN ISI PERFORMANS KRİTERLERİNDEN BAĞIMSIZDIR. THE GLASS THICKNESSES IN THE TABLE ARE THEORETICAL AND INDEPENDENT FROM THERMAL PERFORMANCE CRITERIA OF THE SYSTEM.

YUKARIDAKİ TABLODA VERİLEN CAM-FİTİL VE PROFİL İLİŞKİSİ TEORİK OLUP PROFİL VE CAM TOLERANSLARINDAN KAYNAKLI ÖLÇÜ FARKLILIKLARI OLUŞABİLİR. THE RELATIONSHIP BETWEEN GLASS-GASKET AND PROFILE PROVIDED IN THE TABLE IS THEORETICAL. IT MAY OCCUR SIZE DIFFERENCES FROM THE TOLERANCES OF PROFILE AND GLASS.

PROFİL KODU (PROFILE CODE)	25L03	25L04	25L51	25L52	25J13
FABRİKA KODU(FACTORY CODE)	A002021	A002211	A010887	A010888	A010959
AĞIRLIK (WEIGHT)	4,316 kg/m	7,712 kg/m	4,412 kg/m	4,377 kg/m	0,950 kg/m
ÇİZİM (DRAWING)					

PROFİL KODU (PROFILE CODE)	25L14	25L26
FABRİKA KODU(FACTORY CODE)	A002059	A010540
AĞIRLIK (WEIGHT)	3,270 kg/m	4,870 kg/m
ÇİZİM (DRAWING)		

Nr			KEŞİM ÖLÇÜSÜ CUTTING SIZE	
R46F01	A010856	25L51 (A010887)	39,3 mm	124 L 51
R46F03	A010891			
R46F05	A010908			
R46F02	A010857	25L52 (A010888)	36,7 mm	122 L 52
R46V01	A010858	25L51 (A010887)	39,3 mm	124 L 51
R46V02	A010859	25L52 (A010888)	36,7 mm	122 L 52
R46V03	A010860	25L04 (A002211)	30,7 mm	177 L 04
R46V04	A010861			
R46V05	A010973	25L04 (A002211)	36,7 mm	122 L 04
R46M03	A010960	25L03(A002021)	37,1 mm	113 L 03
R46V06	A011776	25L26 (A010540)	44,4 mm	144 L 26
R46V07	A011777	25L14(A002059)	44,4 mm	144 L 14
Nr			KEŞİM ÖLÇÜSÜ CUTTING SIZE	
R46M03	A010960	25J13 (A010959)	36,9 mm	307 J 13

MİMARİ KATALOG
ARCHITECTURAL CATALOGUE

Alüminyum Kapı ve Pencere Sistemleri
Aluminium Door and Window Systems

RW46

DETAYLAR

DETAILS

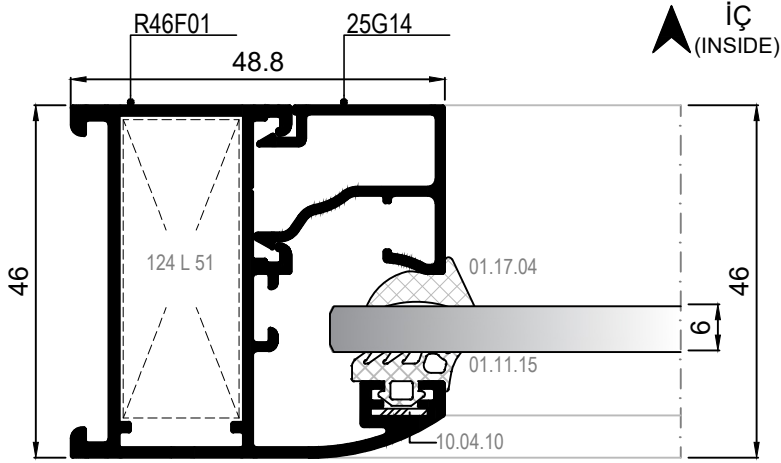
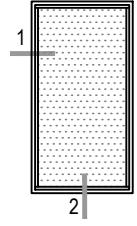

① DETAYI
DETAIL

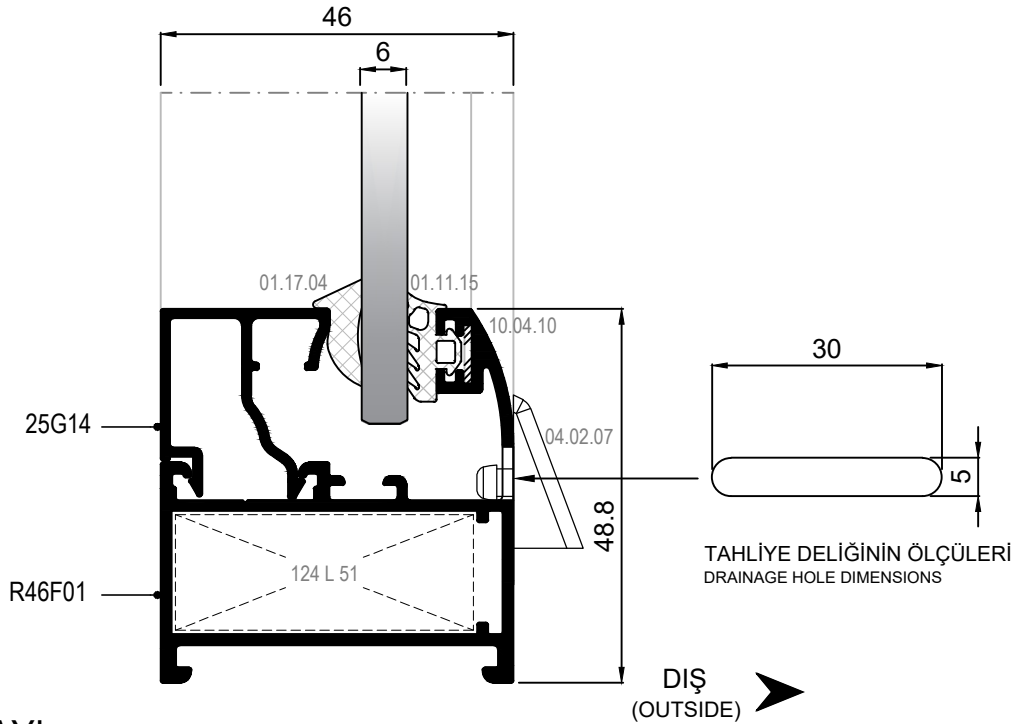

② DETAYI
DETAIL

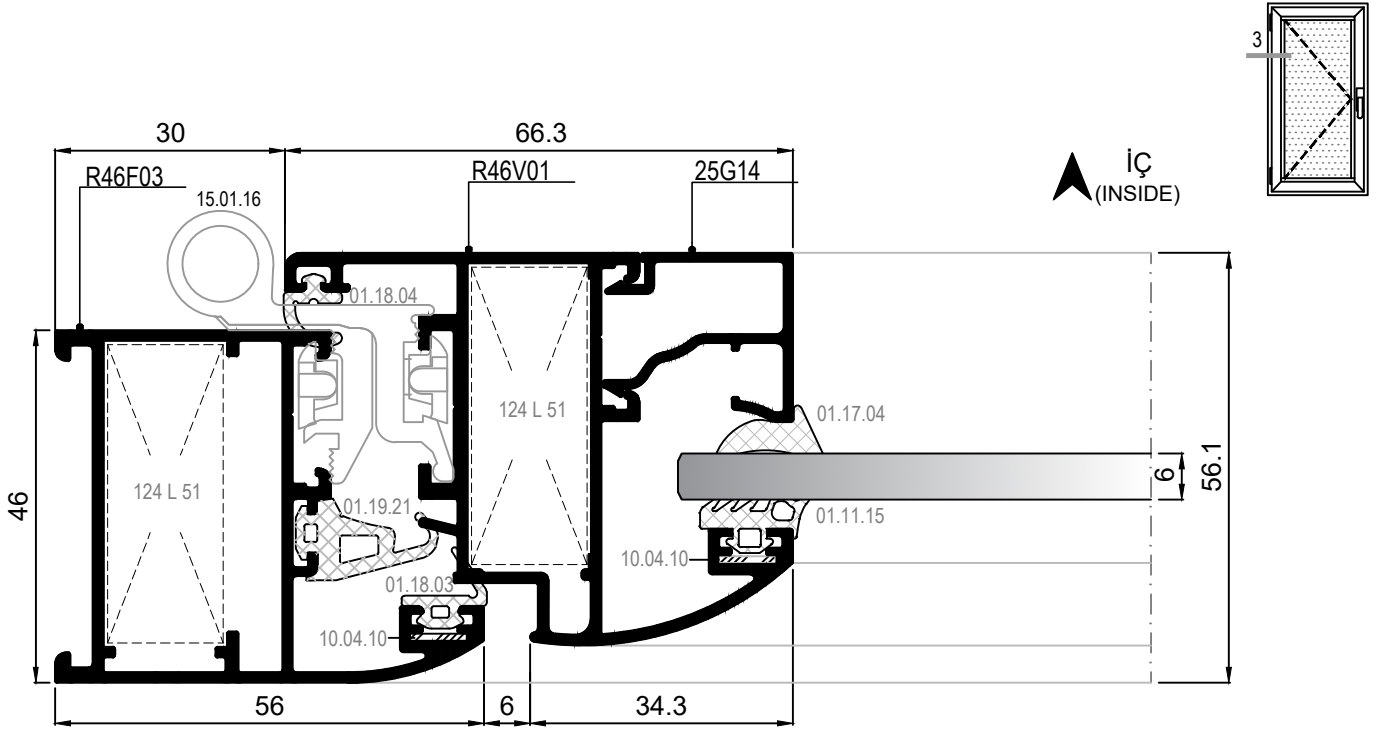

③ DETAYI DETAIL

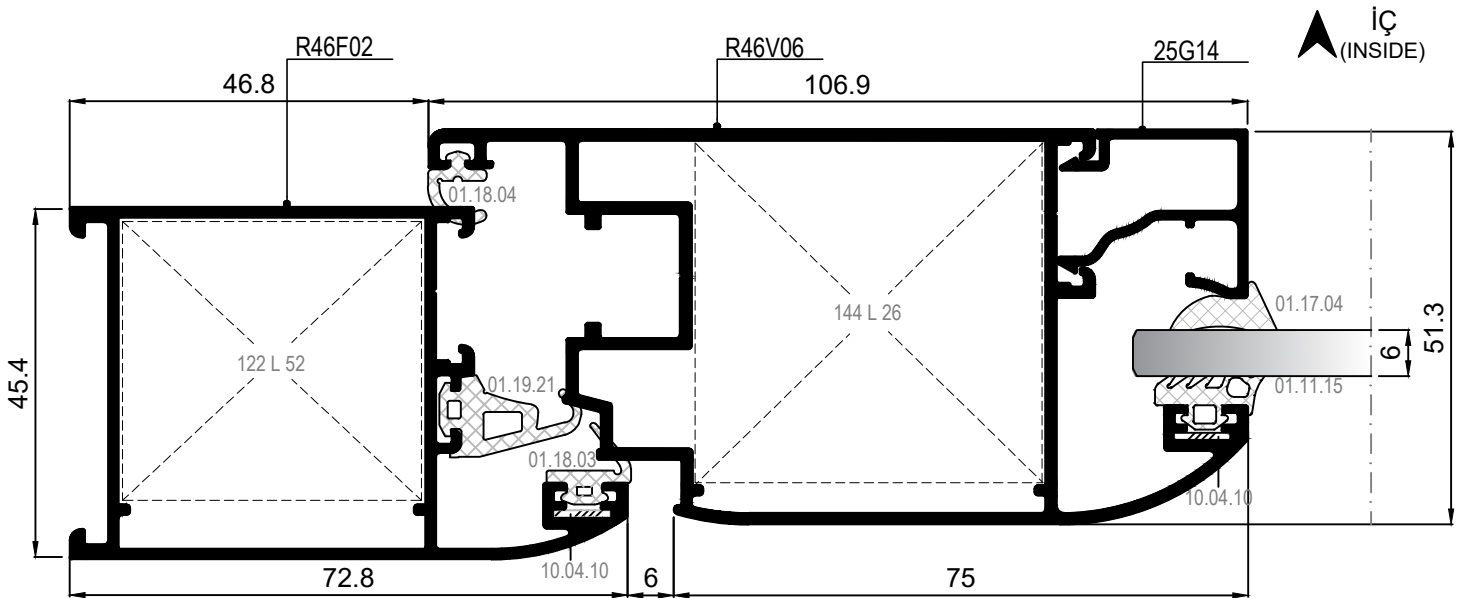

PVC AÇILIM AKSESUARINA UYGUN KANAT DETAYI
VENT DETAIL FOR PVC OPENING ACCESSORIES

③A DETAYI DETAIL

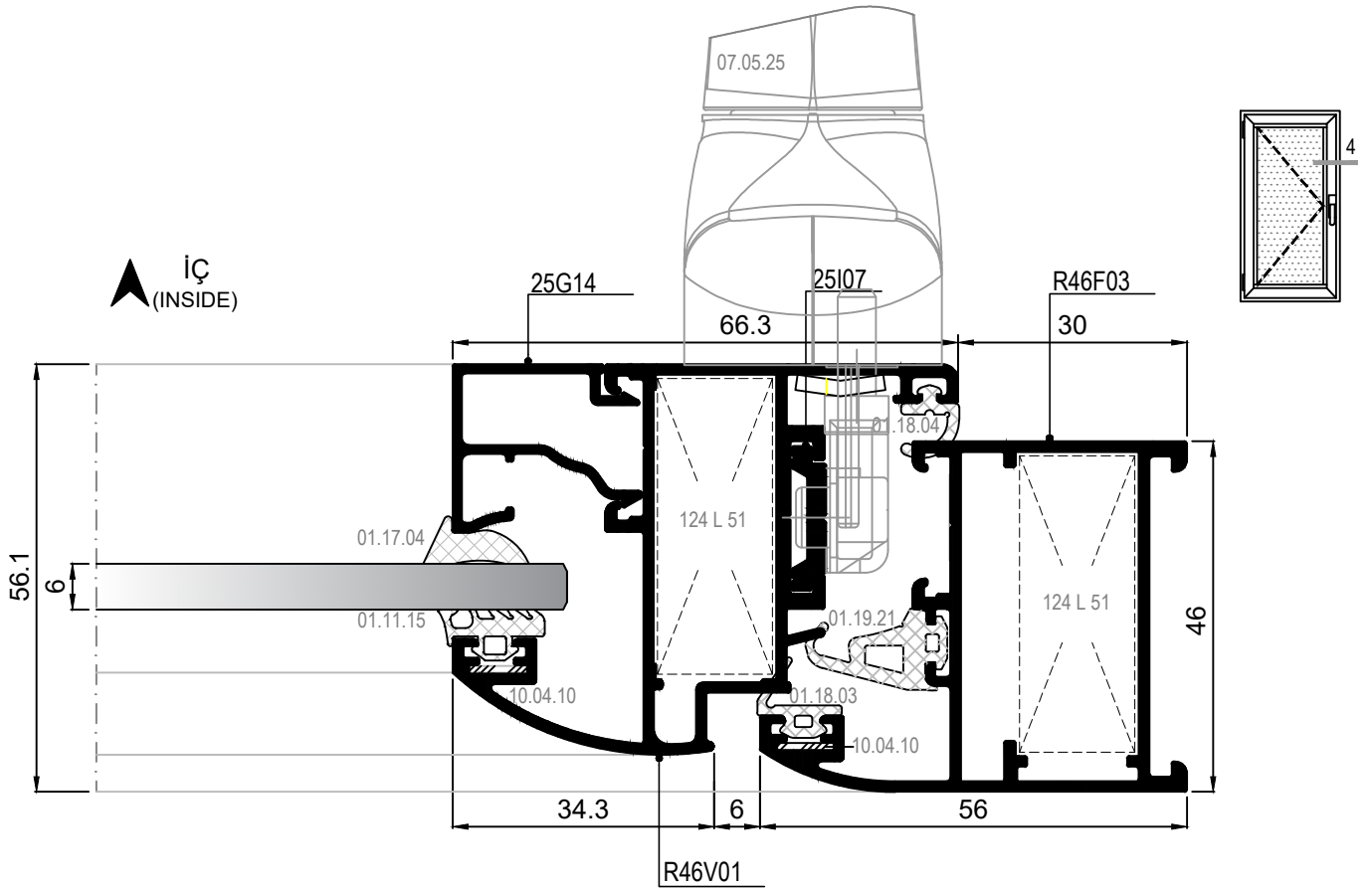

④ DETAYI
DETAIL

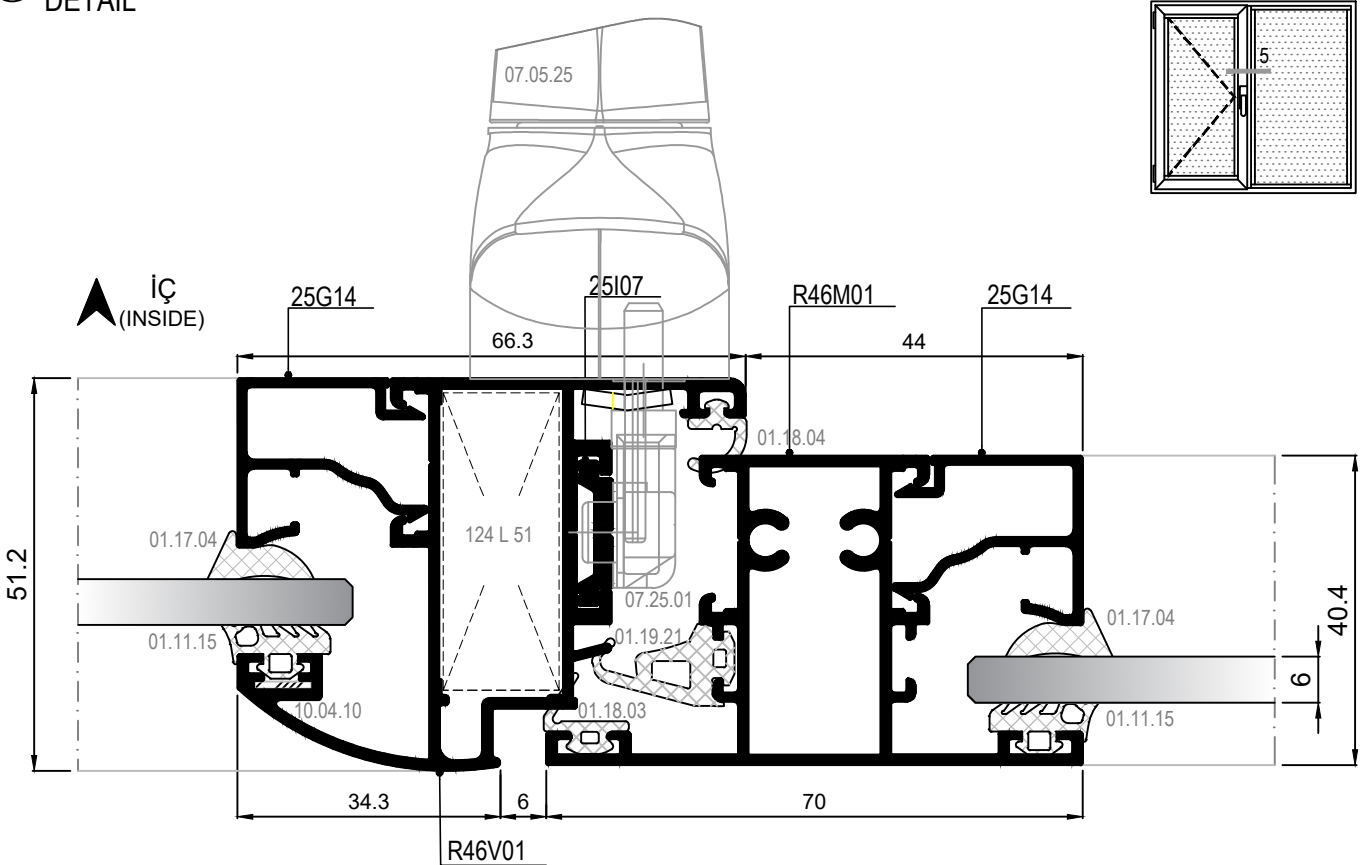

⑤ DETAYI
DETAIL

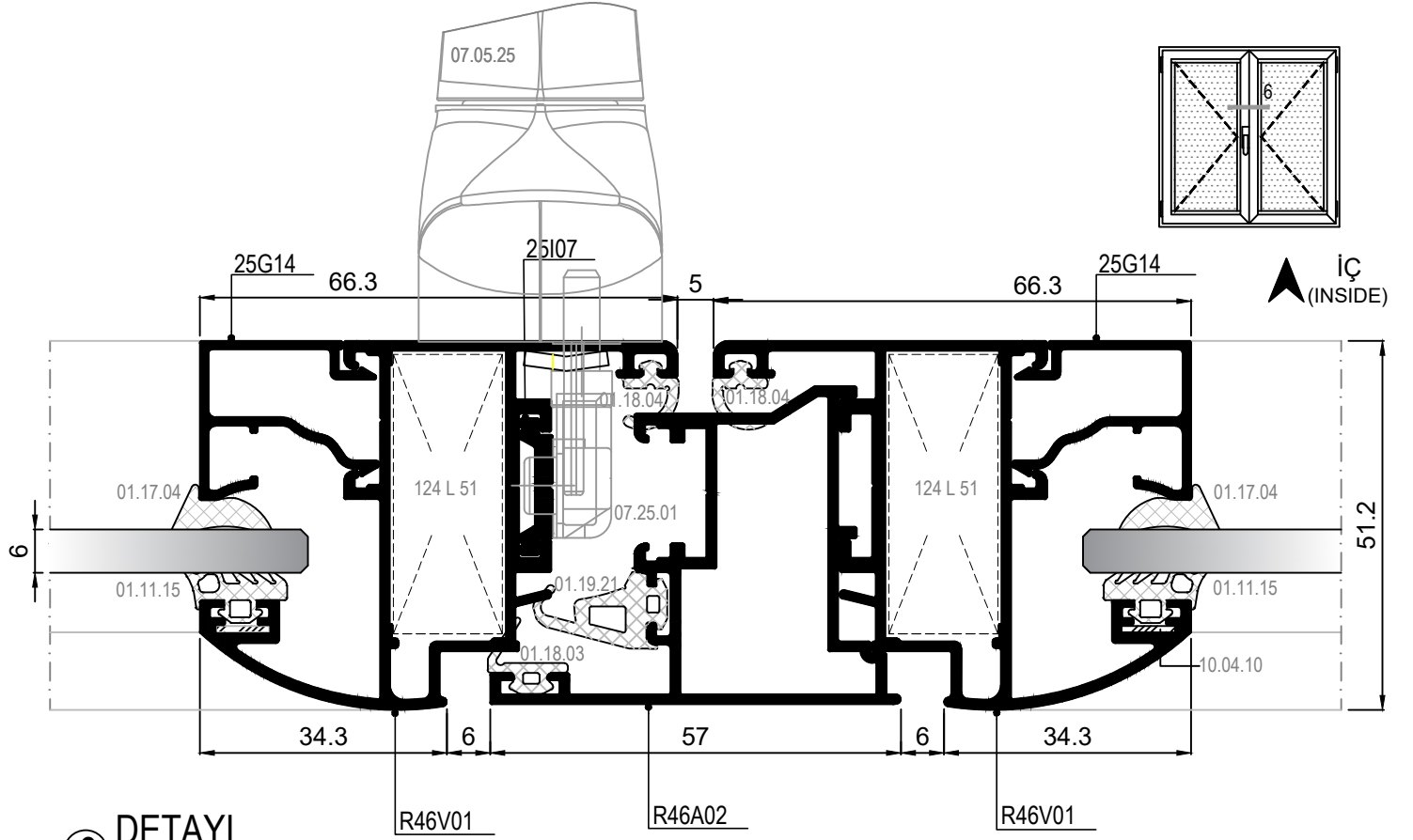

⑥ DETAYI
DETAIL

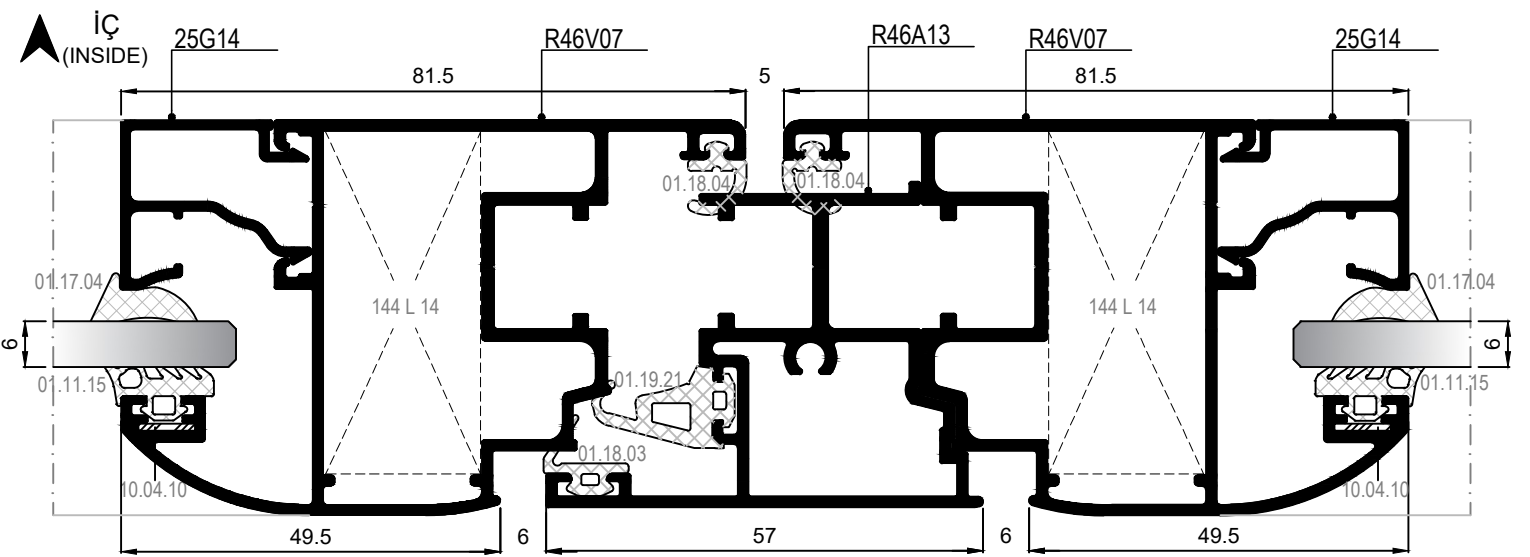

PVC AÇILIM AKSESUARINA UYGUN KANAT DETAYI
VENT DETAIL FOR PVC OPENING ACCESSORIES

⑥A DETAYI
DETAIL

İÇE AÇILIM BİNİLİ KAPI DETAYLARI
INWARD OPENING DOOR DETAILS

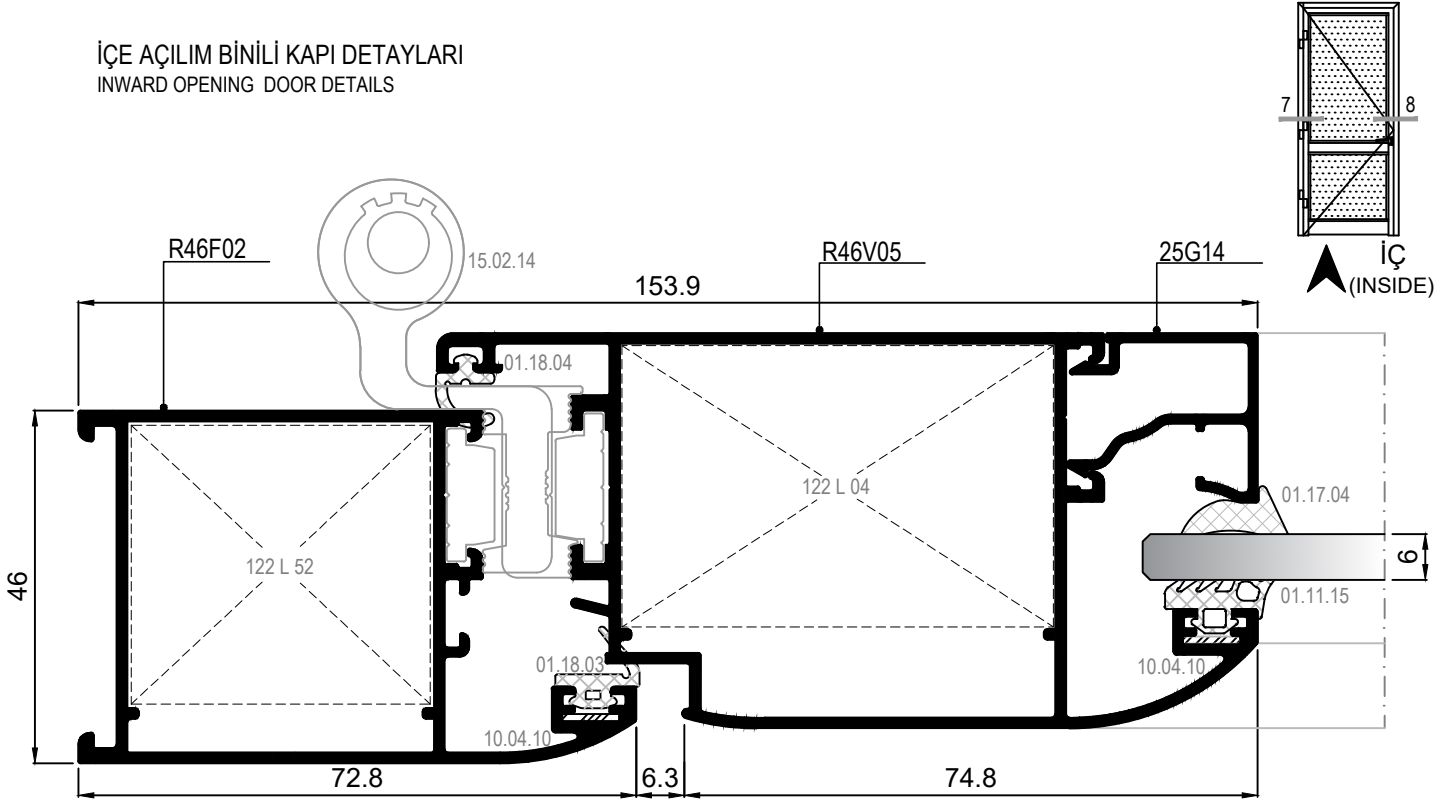

⑦ DETAYI
DETAIL

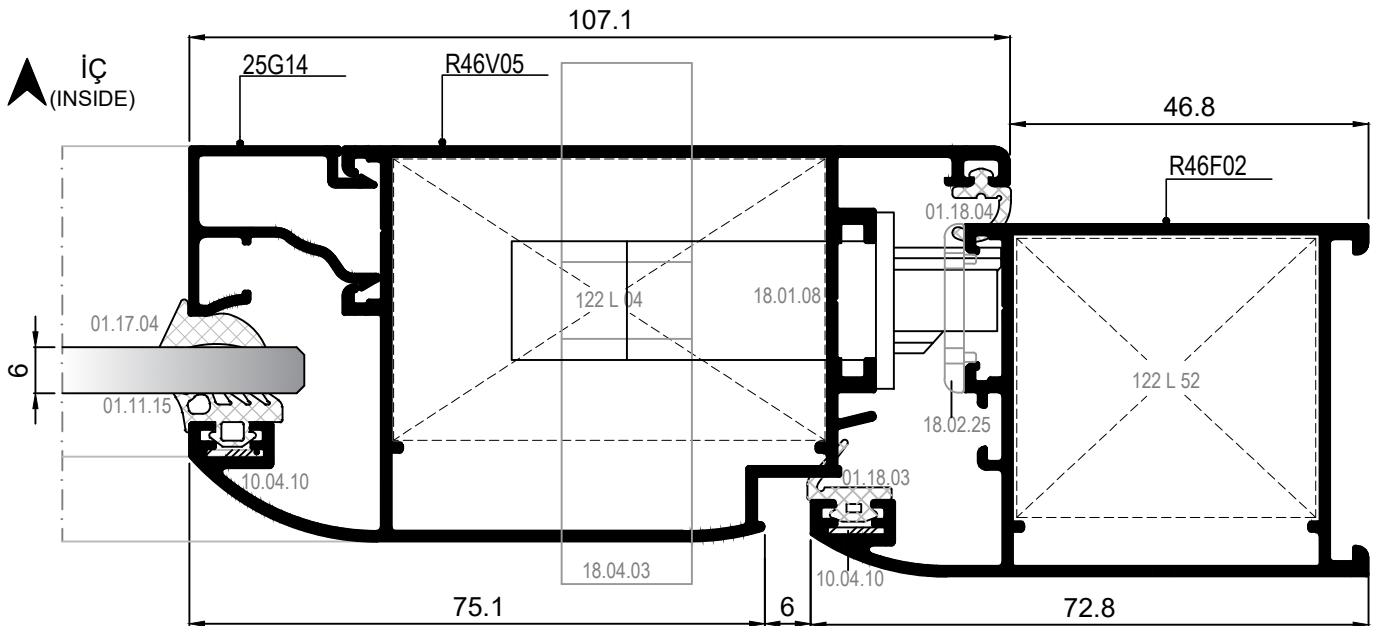

⑧ DETAYI
DETAIL

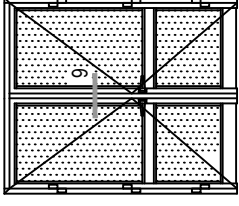

İÇE AÇILIM BNİLİ KAPI DETAYLARI
INWARD OPENING DOOR DETAILS

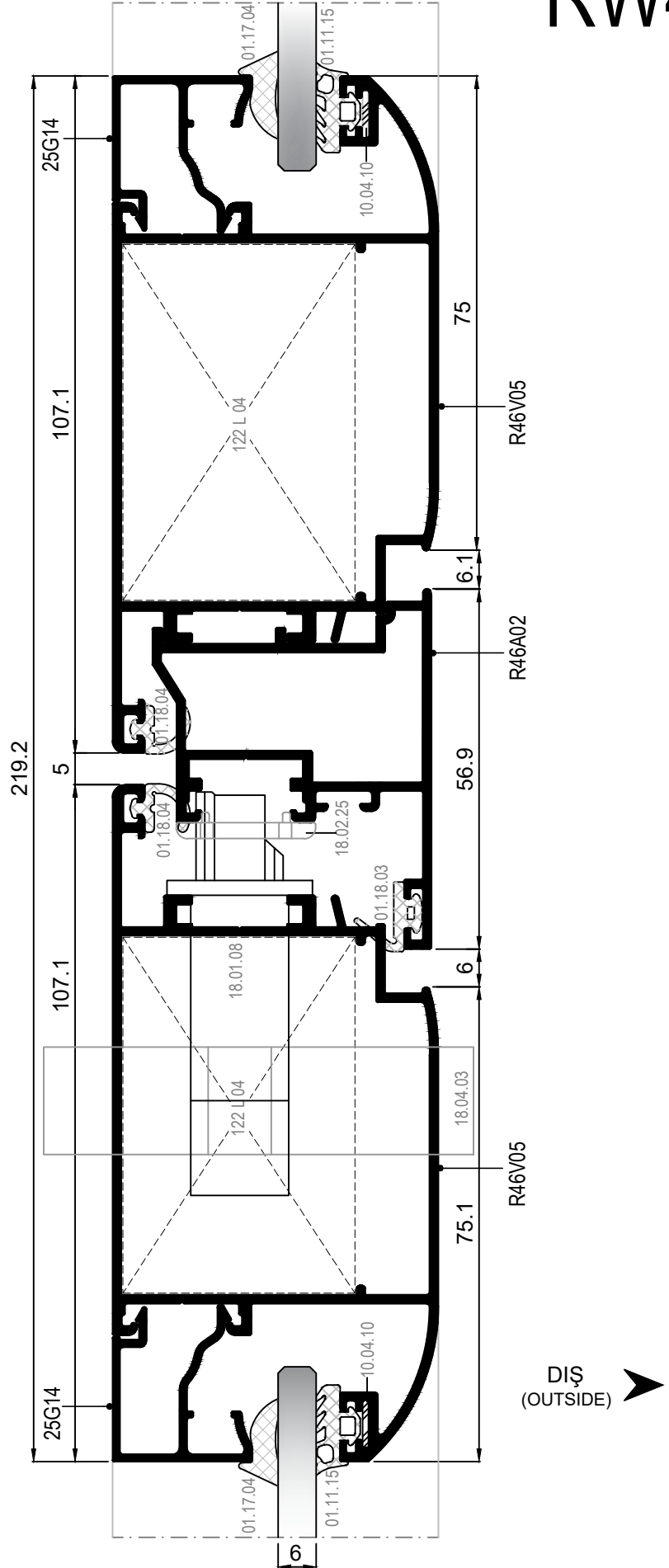

İÇE AÇILIM HEMYÜZ KAPI DETAYLARI
INWARD OPENING FLUSH DOOR DETAILS

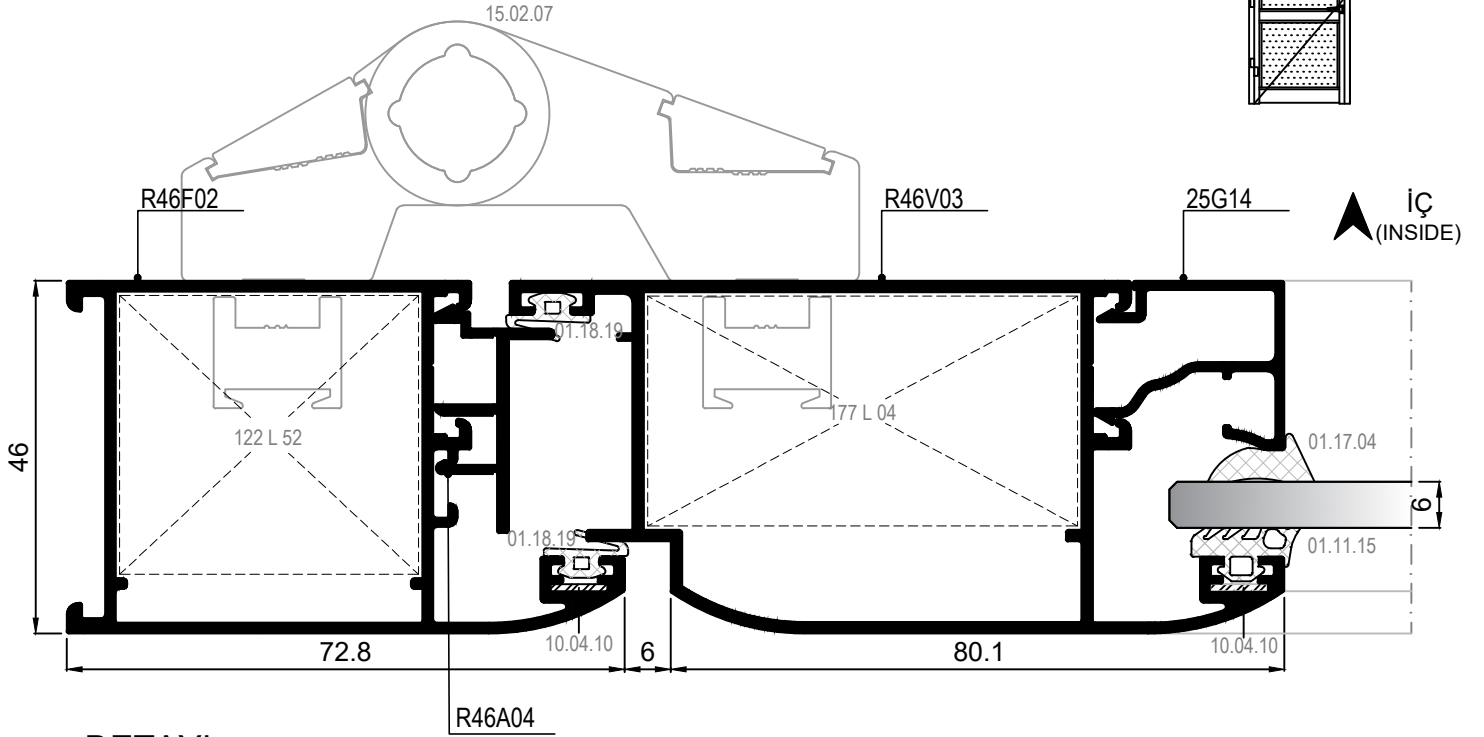
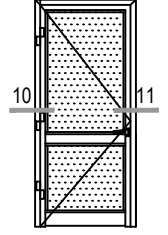

10 DETAYI
DETAIL

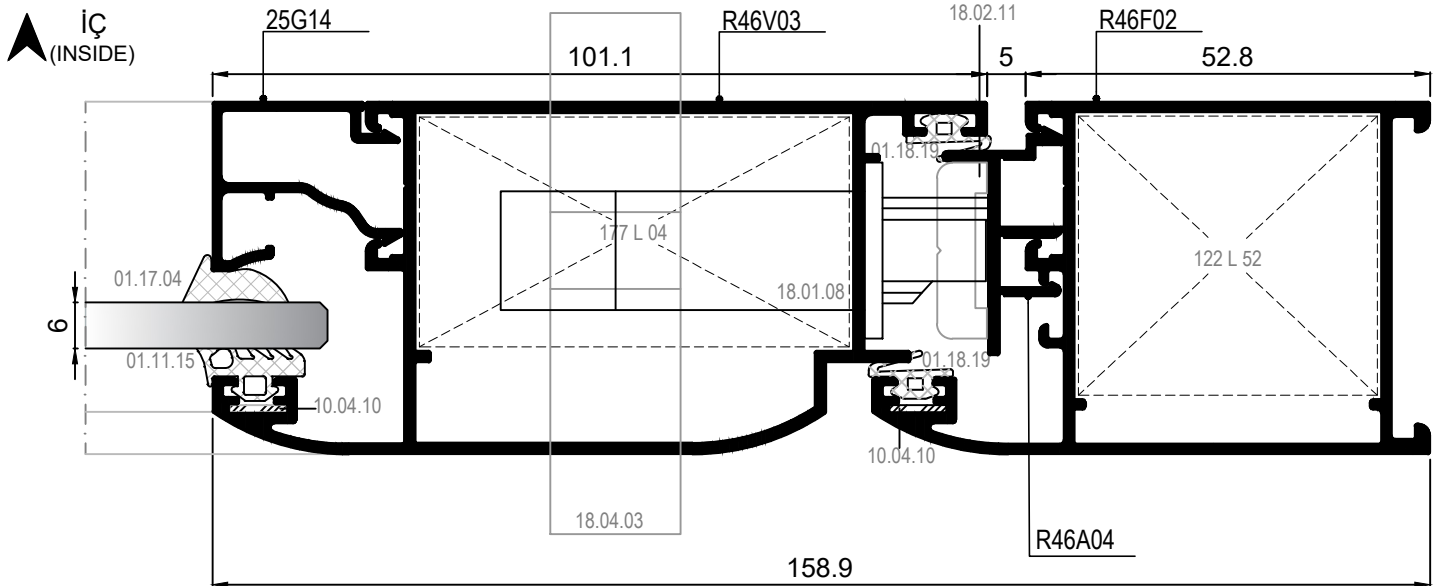

11 DETAYI
DETAIL

DIŐA AÇILIM HEMYÜZ KAPI DETAYLARI
OUTWARD OPENING FLUSH DOOR DETAILS

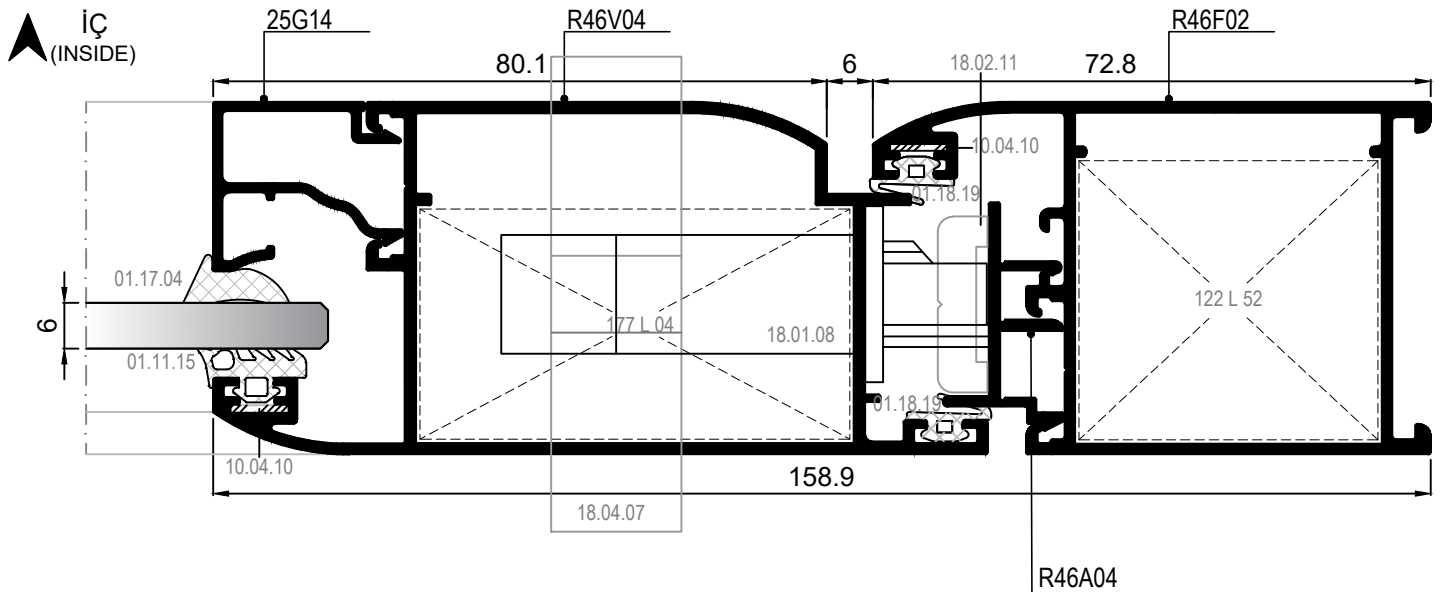
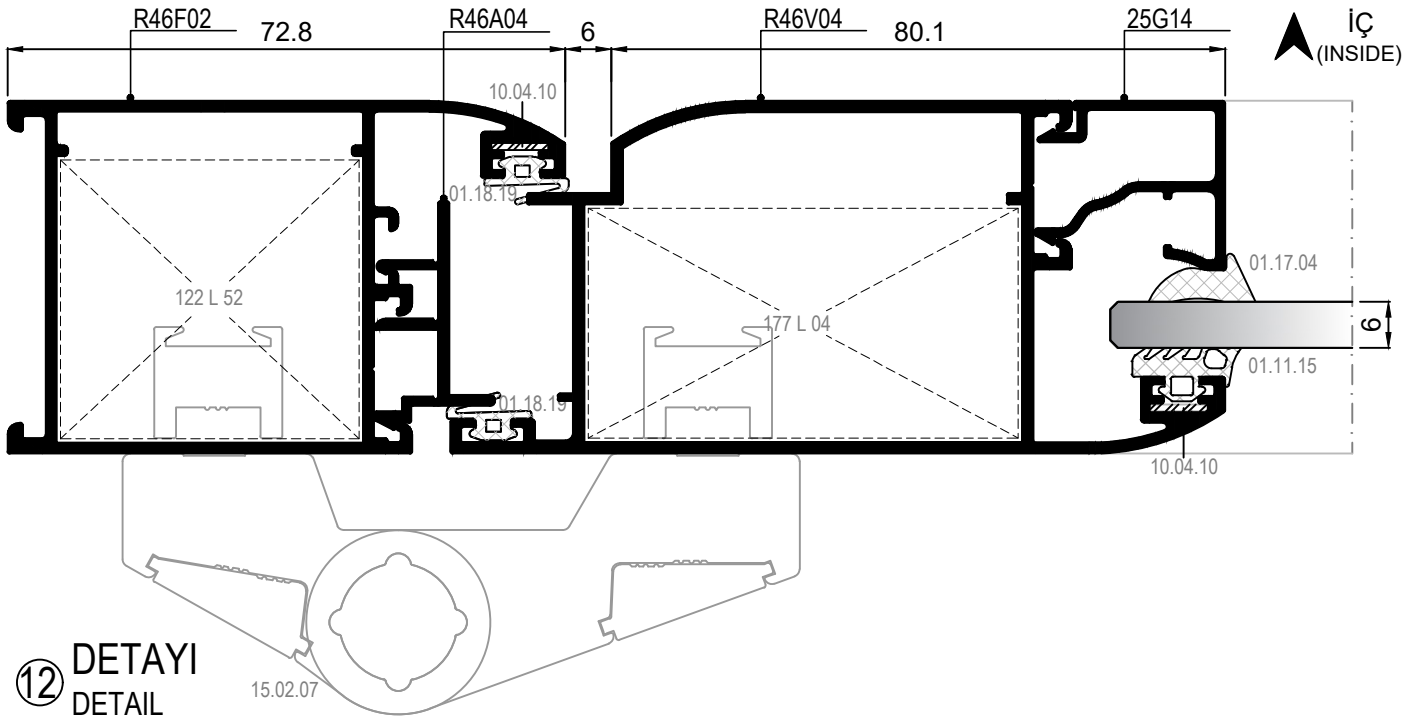
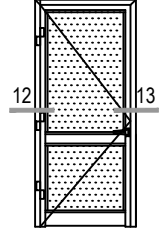

13 DETAYI
DETAIL

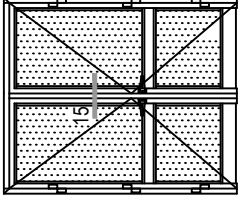

DIŐA AÇILIM HEMYÜZ KAPI DETAYLARI
OUTWARD OPENING FLUSH DOOR DETAILS

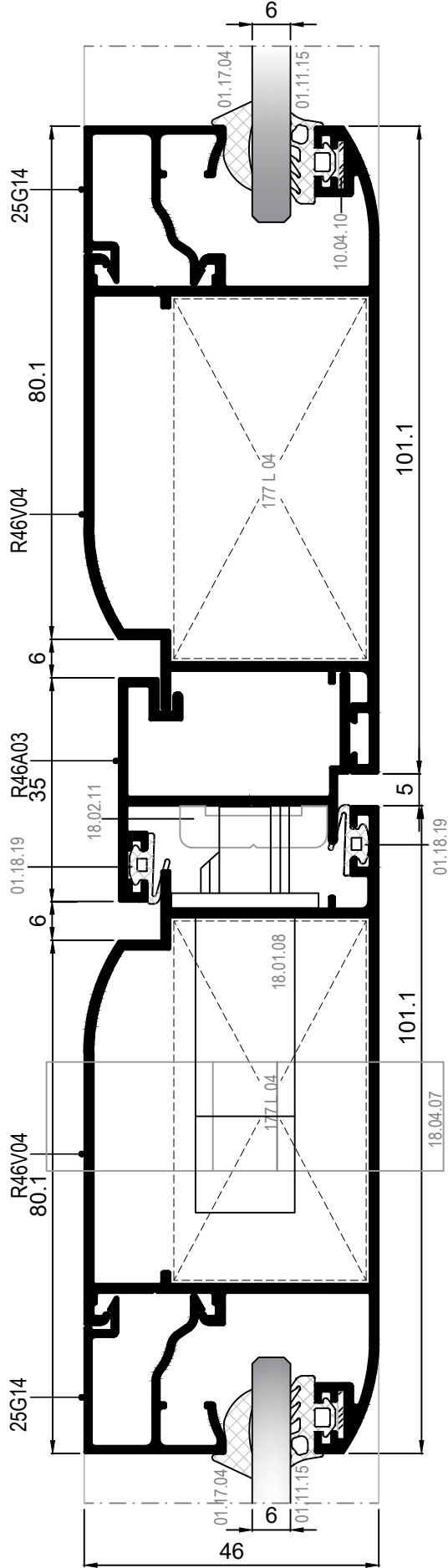

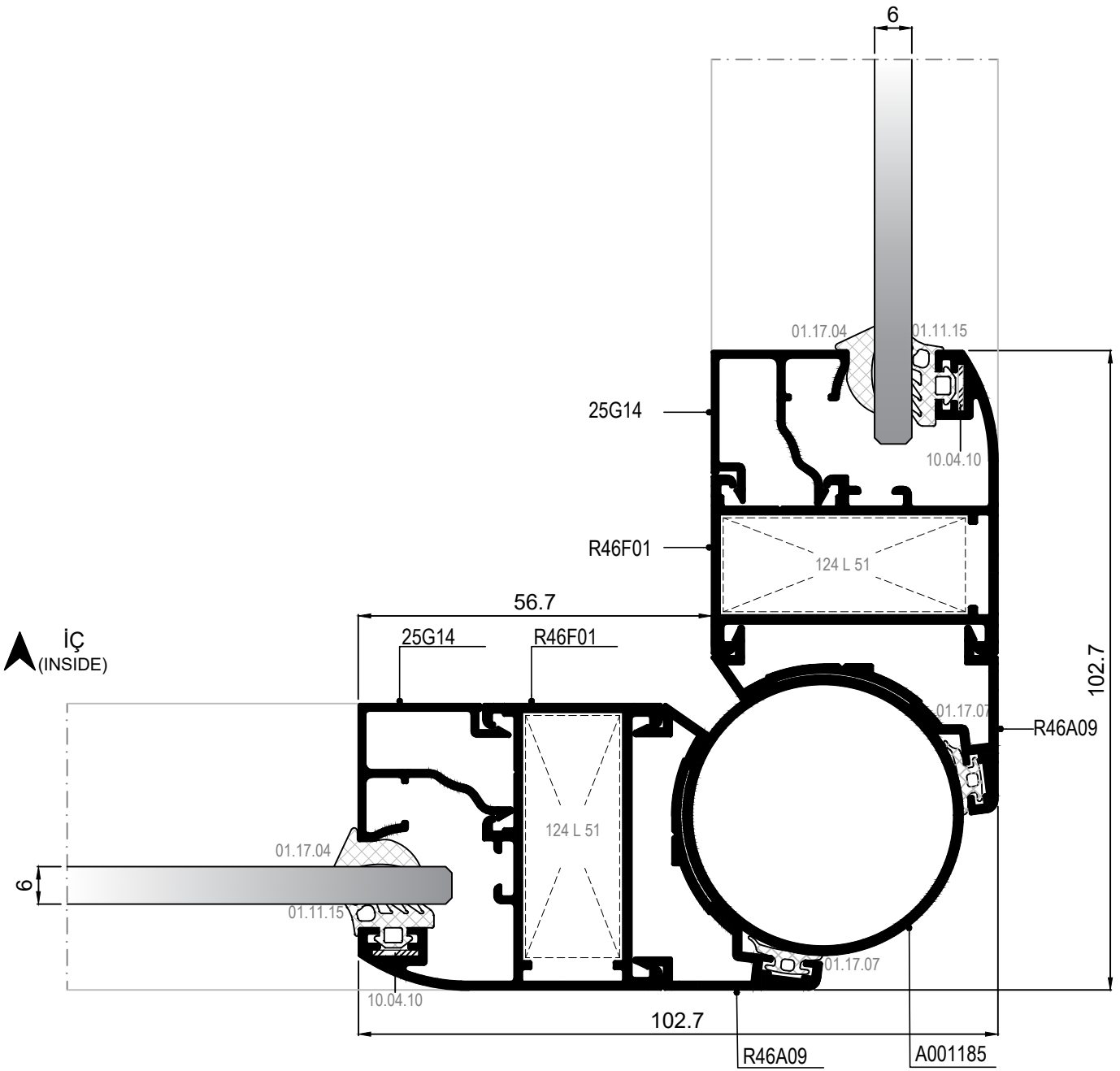
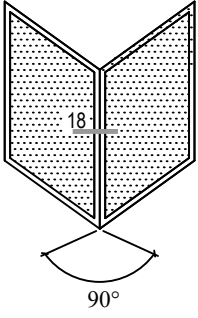

18 DETAYI
DETAIL

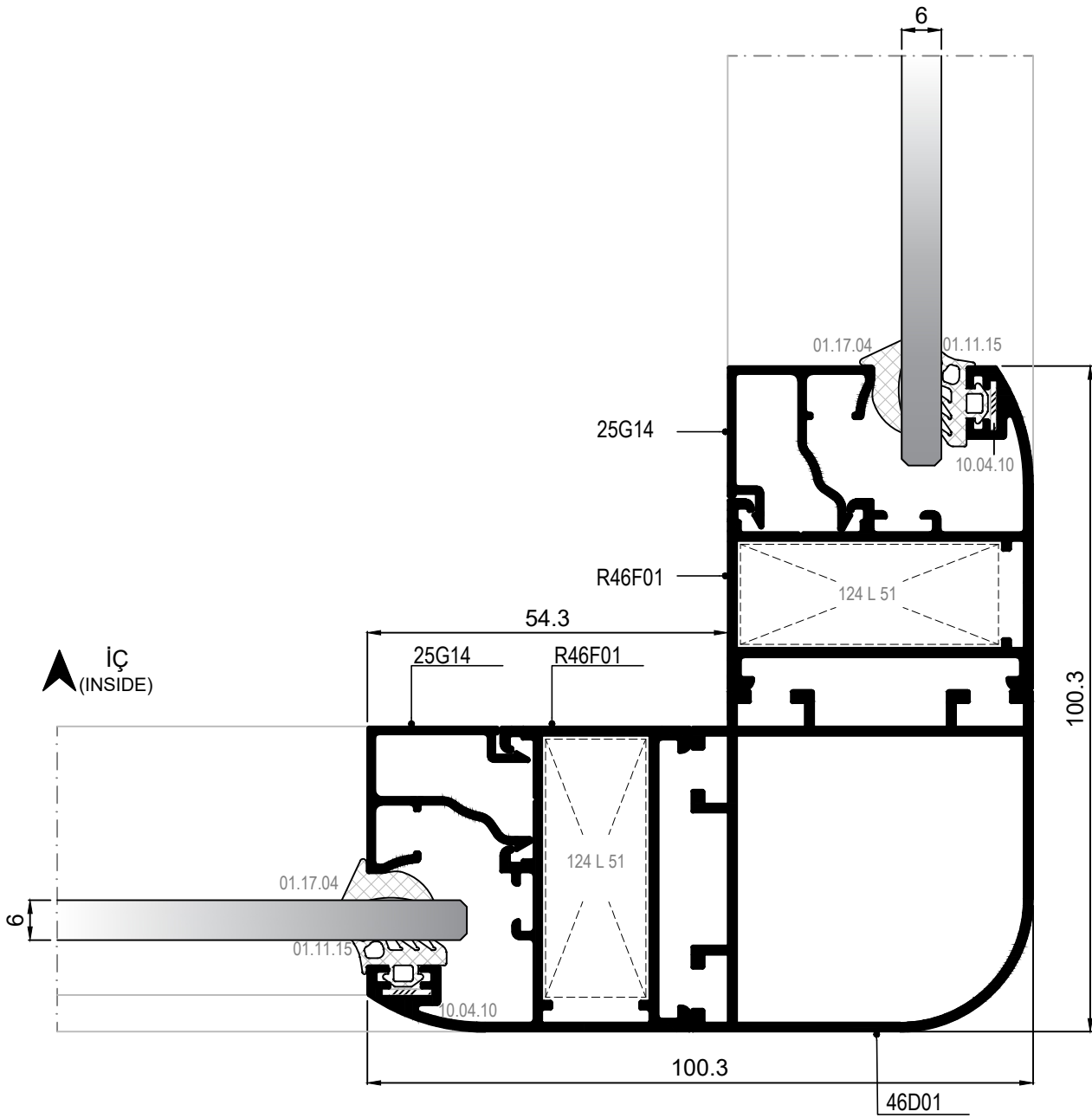
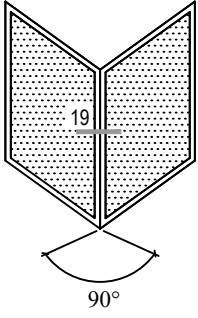

19 DETAYI
DETAIL

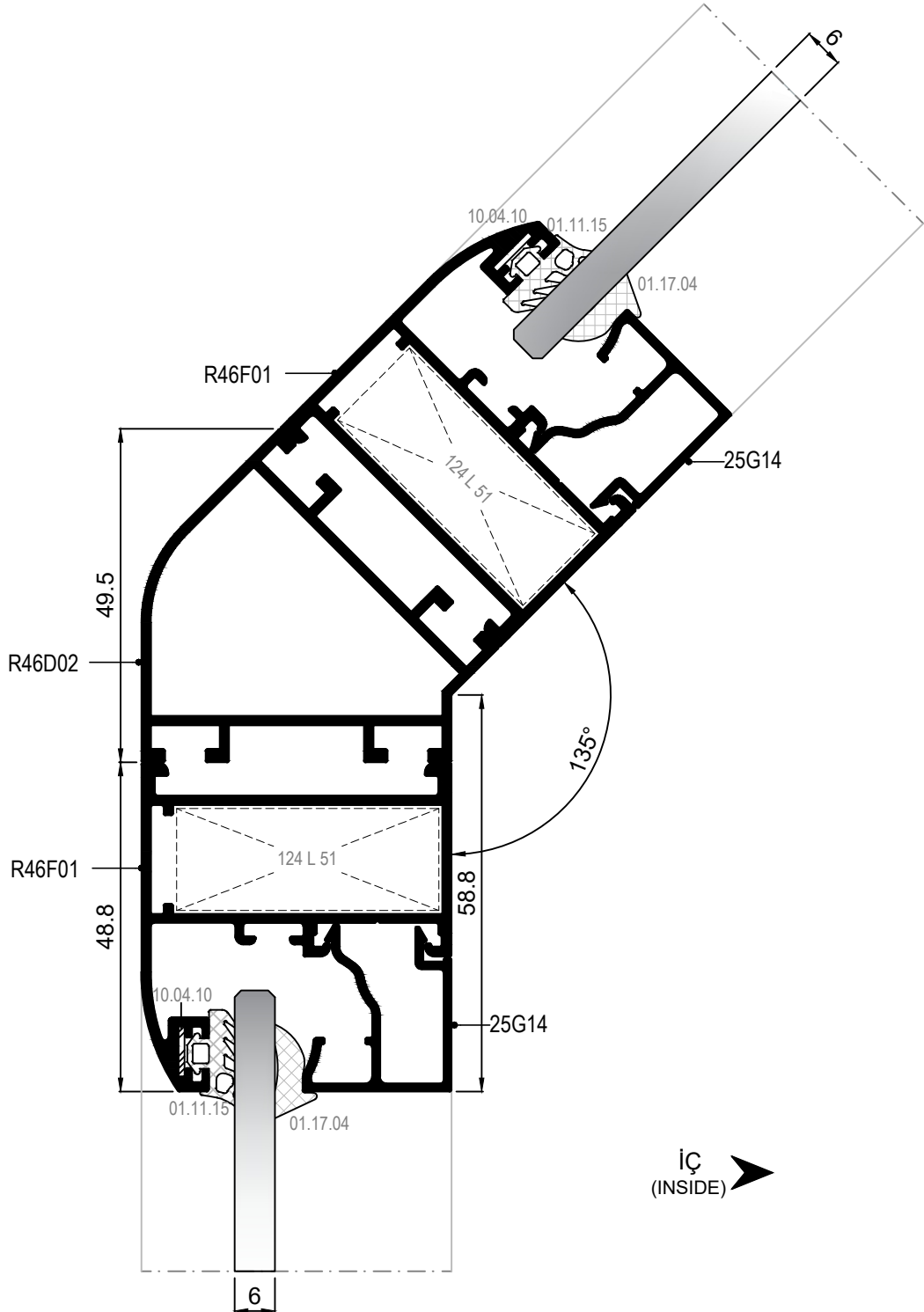
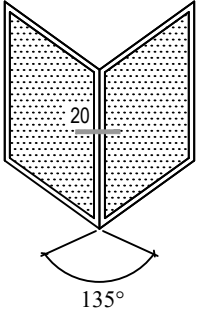

20 DETAYI
DETAIL











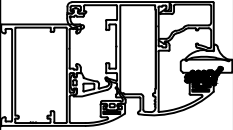

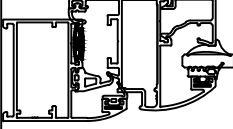

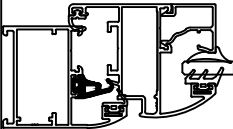

MİMARİ KATALOG
ARCHITECTURAL CATALOGUE

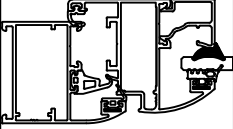

Alüminyum Kapı ve Pencere Sistemleri
Aluminium Door and Window Systems

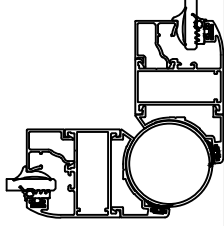
RW46

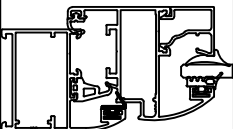
AKSESUARLAR

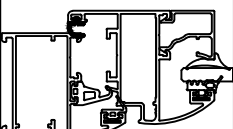
ACCESSORIES

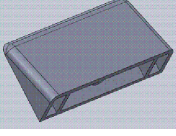
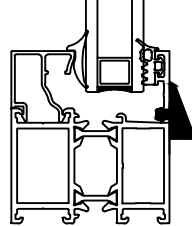
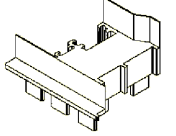
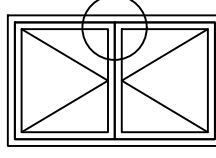
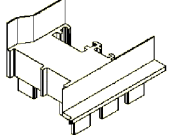
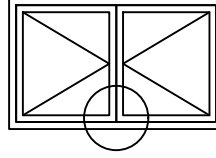
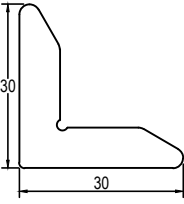
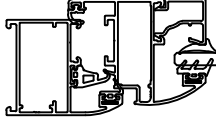
	<p>01.11.15</p> <p>DIŞ CAM FİTİLİ 4 mm OUTSIDE GLAZING GASKET 4 mm</p> <p>Malzeme / Material : EPDM Ağırlık / Weight : 81 gr/m Paket / Package: 185m / 15 kg</p>			<p>01.19.06</p> <p>ÇITA KANAL FİTİLİ ADAPTER GASKET</p> <p>Malzeme / Material : EPDM Ağırlık / Weight : 82 gr/m Paket / Package: 182m / 15 kg</p>	
	<p>01.17.03</p> <p>İÇ CAM FİTİLİ 2,8 mm INSIDE GLAZING GASKET 2,8 mm</p> <p>Malzeme / Material : EPDM Ağırlık / Weight : 59 gr/m Paket / Package: 254 m / 15 kg</p>			<p>01.19.21</p> <p>TOZLUK FİTİLİ CENTRAL GASKET</p> <p>Malzeme / Material : EPDM Ağırlık / Weight : 137 gr/m Paket / Package: 109m / 15 kg</p>	
	<p>01.17.04</p> <p>İÇ CAM FİTİLİ 3,6 mm INSIDE GLAZING GASKET 3,6 mm</p> <p>Malzeme / Material : EPDM Ağırlık / Weight : 71 gr/m Paket / Package: 210m / 15 kg</p>				
	<p>01.17.05</p> <p>İÇ CAM FİTİLİ 4,6 mm INSIDE GLAZING GASKET 4,6 mm</p> <p>Malzeme / Material : EPDM Ağırlık / Weight : 89 gr/m Paket / Package: 168 m / 15 kg</p>				
	<p>01.17.07</p> <p>DIŞ BİNİ FİTİLİ OUTSIDE ACOUSTICAL GASKET</p> <p>Malzeme / Material : EPDM Ağırlık / Weight : 33 gr/m Paket / Package: 454m / 15 kg</p>				
	<p>01.18.03</p> <p>DIŞ BİNİ FİTİLİ OUTSIDE ACOUSTICAL GASKET</p> <p>Malzeme / Material : EPDM Ağırlık / Weight : 41 gr/m Paket / Package: 365m / 15 kg</p>				
	<p>01.18.04</p> <p>İÇ BİNİ FİTİLİ INSIDE ACOUSTICAL GASKET</p> <p>Malzeme / Material : EPDM Ağırlık / Weight : 42 gr/m Paket / Package: 360m / 15 kg</p>				

	04.02.07 TAHLİYE KAPAĞI DRAINAGE COVER Malzeme / Material : PVC Renk / Colour : Siyah-Beyaz-Gri Black-White-Grey				
	04.06.34 ADAPTÖR KAPAĞI ADAPTER CAP Malzeme / Material : PVC Renk / Colour : Siyah / Black R46A02 İÇİN / FOR R46A02				
	04.06.35 ADAPTÖR KAPAĞI ADAPTER CAP Malzeme / Material : PVC Renk / Colour : Siyah / Black R46A02 İÇİN / FOR R46A02	 USE WITH: R46 A 02			
	10.04.10 KÖŞE ÇAVUŞU CORNER PIECE Malzeme / Material : Paslanmaz çelik/ Stainless steel				
	10.10.01 MONTAJ LAMASI (140mm) LAMA FOR ASSEMBLY (140mm)				

PENCERE MENTEŞELERİ / WINDOW HINGES



15.01.16

GESSE PENCERE MENTEŞESİ
GESSE HINGE FOR WINDOWS

Renk / Colour : Siyah-Beyaz-Gri-Eloksal
Black-White-Grey-Anodized

75 kg için 2 adet, 85 kg için 3 adet kullanılmalıdır. / Should be used 2 for 75 kg, 3 for 85 kg.
EN 1935:2002

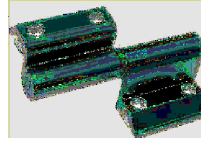

15.01.03

RESCARA PENCERE MENTEŞESİ
RESCARA HINGE FOR WINDOWS

Renk / Colour : Pres-Eloksal
Press-Anodized

75 kg için 2 adet, 85 kg için 3 adet kullanılmalıdır. / Should be used 2 for 75 kg, 3 for 85 kg.
EN 1935:2002

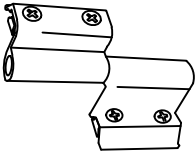

15.01.08

YERLİ PENCERE MENTEŞESİ
LOCAL HINGE FOR WINDOWS

Renk / Colour : Siyah-Beyaz-Gri-Eloksal
Black-White-Grey-Anodized

50 kg için 2 adet kullanılmalıdır. / Should be used 2 for 50 kg.
Max. kanat ölçüsü 900x1300 / Max. vent dimension 900x1300
TS EN 1935

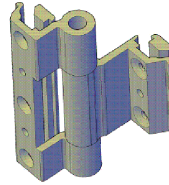

15.01.12

YERLİ PENCERE MENTEŞESİ
LOCAL HINGE FOR WINDOWS

Renk / Colour : Siyah-Beyaz-Gri-Eloksal
Black-White-Grey-Anodized

TS EN 1935



15.01.17

GESSE GİZLİ PENCERE MENTEŞESİ (SAĞ)
GESSE HIDDEN HINGE FOR WINDOWS (RIGHT)

Malzeme / Material : Paslanmaz Çelik
Stainless Steel

100 kg için 2 adet kullanılmalıdır. / Should be used 2 for 100 kg.



15.01.18

GESSE GİZLİ PENCERE MENTEŞESİ (SOL)
GESSE HIDDEN HINGE FOR WINDOWS (LEFT)

Malzeme / Material : Paslanmaz Çelik
Stainless Steel

100 kg için 2 adet kullanılmalıdır. / Should be used 2 for 100 kg.

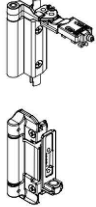

15.01.20

RESCARA PASİF KANAT MENTEŞESİ
RESCARA PASSIVE LEAF HINGE

Renk / Colour : Siyah-Beyaz-Gri-Eloksal
Black-White-Grey-Anodized

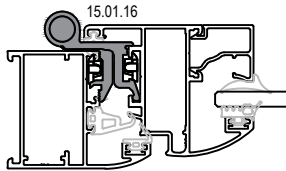

15.01.16

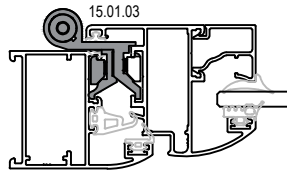

15.01.03

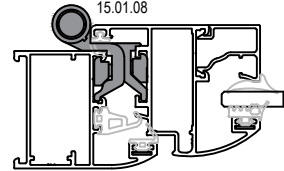

15.01.08

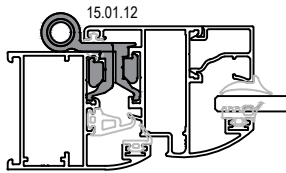

15.01.12

Ölçek/Scale: x

KAPI MENTEŞELERİ / DOOR HINGES



15.02.20

RESCARA KAPI MENTEŞESİ
RESCARA HINGE FOR DOORS

Renk / Colour : Siyah-Beyaz-Gri-Pres-Eloksal
Black-White-Grey-Press-Anodized

120 kg için 2 adet kullanılmalıdır. / Should be used 2 for 120 kg.
TS EN 1935



15.02.09

YERLİ KAPI MENTEŞESİ
LOCAL HINGE FOR DOORS

Renk / Colour : Siyah-Beyaz-Gri-Eloksal
Black-White-Grey-Anodized

85 kg için 3 adet kullanılmalıdır. / Should be used 3 for 85 kg.
Max. kanat ölçüsü 900x2200 / Max. vent dimension 900x2200
TS EN 1935

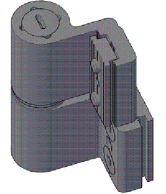

15.02.12

YERLİ KAPI MENTEŞESİ
LOCAL HINGE FOR DOORS

Renk / Colour : Siyah-Beyaz-Gri-Eloksal
Black-White-Grey-Anodized

100 kg için 3 adet kullanılmalıdır. / Should be used 3 for 100 kg.
Max. kanat ölçüsü 900x2300 / Max. vent dimension 900x2300
TS EN 1935

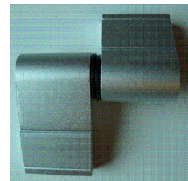

15.02.07

YERLİ KAPI MENTEŞESİ
LOCAL HINGE FOR DOORS

Renk / Colour : Siyah-Beyaz-Gri-Eloksal
Black-White-Grey-Anodized

100 kg için 2 adet kullanılmalıdır. / Should be used 2 for 100 kg.
Max. kanat ölçüsü 900x2200 / Max. vent dimension 900x2200
TS EN 1935



15.02.14

GIESSE KAPI MENTEŞESİ
GIESSE HINGE FOR DOORS

Renk / Colour : Siyah-Beyaz-Eloksal
Black-White-Anodized

100 kg için 2 adet, 120 kg için 3 adet kullanılmalıdır. / Should be used 2 for 100 kg, 3 for 120 kg.
EN 1935

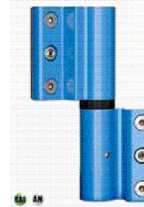

15.02.21

RESCARA KAPI MENTEŞESİ
RESCARA HINGE FOR DOORS

Renk / Colour : Siyah-Beyaz-Gri-Pres-Eloksal
Black-White-Grey-Press-Anodized

160 kg için 2 adet kullanılmalıdır. / Should be used 2 for 160 kg.
TS EN 1935

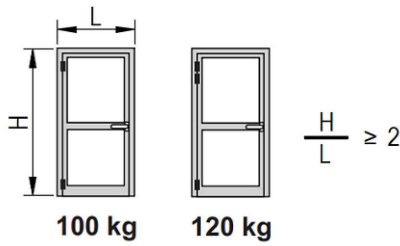

KNT. YÜKSEKLİĞİ / SASH HEIGHT KNT. GENİŞLİĞİ / SASH WIDTH	KANAT AĞIRLIĞI SASH WEIGHT
$\frac{H}{L} = 1.9$	Max (- 10%)
$\frac{H}{L} = 1.8$	Max (- 20%)
= ...	Max (- ...%)
$\frac{H}{L} \leq 1$	UYGULANAMAZ NA

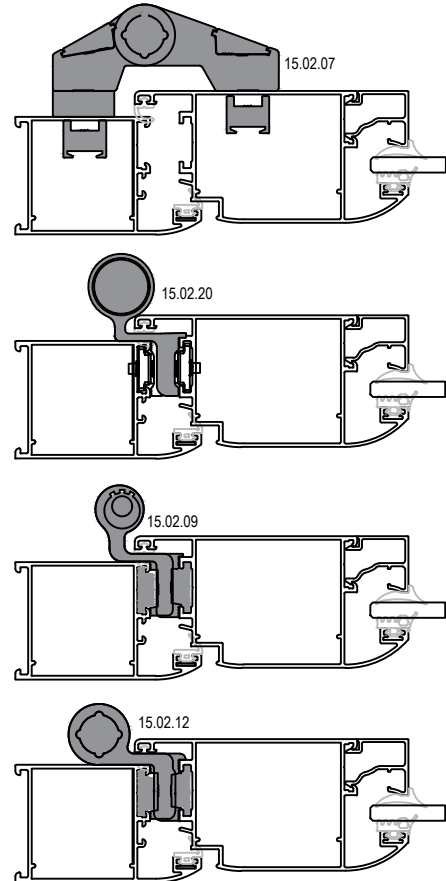

Ölçek/Scale: 1/2

ÇİFT EKSEN MEKANİZMALARI / TILT & TURN MECHANISMS

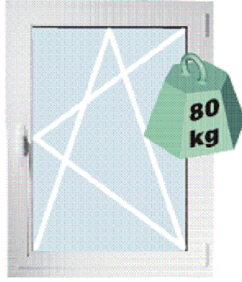

GIESSE FUTURA ÇİFT AÇILIM SETİ 80 kg
GIESSE FUTURA TILT & TURN MECHANISM 80 kg

Renk / Colour : Siyah-Beyaz-Gri
Black-White-Grey

ADET NUMBER	07.06.001 MEKANİZMA MECHANISM	07.06.002 MENTEŞE SETİ HINGE KIT	07.06.003 TİP1 MAKAS TYPE1 ARM	07.06.004 TİP2 MAKAS TYPE2 ARM	07.06.005 KOL HANDLE	07.06.006 İLAVE KİLİTLEME ADDITIONAL LOCKING	07.06.007 İLAVE MAKAS ADDITIONAL ARM
L: 410-569mm H: 600-1200mm	1	1	1	---	1	---	---
L: 410-569mm H: 1201-2500mm	1	1	1	---	1	1	---
L: 570-1000mm H: 600-1200mm	1	1	---	1	1	---	---
L: 570-1000mm H: 1201-2500mm	1	1	---	1	1	1	---
L: 1001-1700mm H: 600-1200mm	1	1	---	1	1	1	1
L: 1001-1700mm H: 1201-2500mm	1	1	---	1	1	2	1

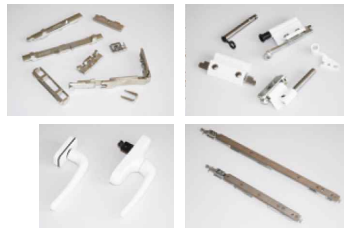

GIESSE FUTURA ÇİFT AÇILIM SETİ 130 kg
GIESSE FUTURA TILT & TURN MECHANISM 130 kg

Renk / Colour : Siyah-Beyaz-Gri
Black-White-Silver

ADET NUMBER	07.06.001 MEKANİZMA MECHANISM	07.06.016 MENTEŞE SETİ HINGE KIT	07.06.013 TİP1 MAKAS TYPE1 ARM	07.06.014 TİP2 MAKAS TYPE2 ARM	07.06.005 KOL HANDLE	07.06.006 İLAVE KİLİTLEME ADDITIONAL LOCKING	07.06.007 İLAVE MAKAS ADDITIONAL ARM
L: 410-700mm H: 600-1200mm	1	1	1	---	1	---	---
L: 410-700mm H: 1201-3000mm	1	1	1	---	1	1	---
L: 701-1000mm H: 600-1200mm	1	1	---	1	1	---	---
L: 701-1000mm H: 1201-3000mm	1	1	---	1	1	1	---
L: 1001-1800mm H: 600-1200mm	1	1	---	1	1	1	1
L: 1001-1800mm H: 1201-3000mm	1	1	---	1	1	2	1

ÇİFT EKSEN MEKANİZMALARI / TILT & TURN MECHANISMS

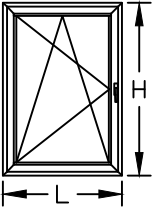
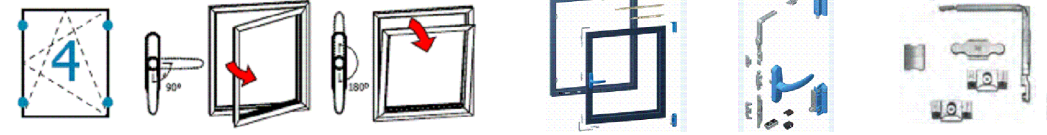
	<p>RESCARA ÇİFT AÇILIM SETİ 130 kg RESCARA TILT & TURN MECHANISM 130 kg Renk / Colour : Siyah-Beyaz-Gri Black-White-Grey</p>					
						
KANAT GENİŞLİĞİ SASH WIDTH L (mt)	KANAT YÜKSEKLİĞİ SASH HEIGHT H (mt)	KANAT AĞIRLIĞI SASH WEIGHT KG	MEKANİZMA MECHANISM	MAKAS ARM	İLAVE KİLİTLEME ADDITIONAL LOCKING	İLAVE MAKAS ADDITIONAL ARM
563-1000 mm	600-1200 mm	130 kg	07.06.79	07.06.80	—	—
563-1000 mm	1200-2500 mm	130 kg	07.06.79	07.06.80	07.06.76	—
1000-1700 mm	600-1200 mm	130 kg	07.06.79	07.06.80	07.06.76	07.06.77
1000-1700 mm	1200-2500 mm	130 kg	07.06.79	07.06.80	07.06.76 (2 ADET)	07.06.77

ÇİFT EKSEN MEKANİZMALARI / TILT & TURN MECHANISMS

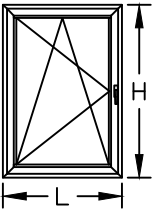
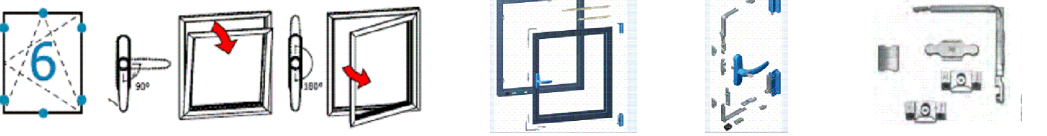
	<p>RESCARA AKILLI ÇİFT AÇILIM SETİ 130 kg / KOL ANAHTARLIDIR. RESCARA TBT TILT & TURN MECHANISM 130 kg / HANDLE WITH KEYLOCK Renk / Colour : Siyah-Beyaz-Gri Black-White-Grey</p>					
						
KANAT GENİŞLİĞİ SASH WIDTH L (mt)	KANAT YÜKSEKLİĞİ SASH HEIGHT H (mt)	KANAT AĞIRLIĞI SASH WEIGHT KG	MEKANİZMA MECHANISM	MAKAS ARM	İLAVE KİLİTLEME ADDITIONAL LOCKING	İLAVE MAKAS ADDITIONAL ARM
563-1000 mm	600-1200 mm	130 kg	07.06.74 (TBT)	07.06.75 (TBT)	—	—
563-1000 mm	1200-2500 mm	130 kg	07.06.74 (TBT)	07.06.75 (TBT)	07.06.76	—
1000-1700 mm	600-1200 mm	130 kg	07.06.74 (TBT)	07.06.75 (TBT)	—	07.06.77
1000-1700 mm	1200-2500 mm	130 kg	07.06.74 (TBT)	07.06.75 (TBT)	07.06.76	07.06.77

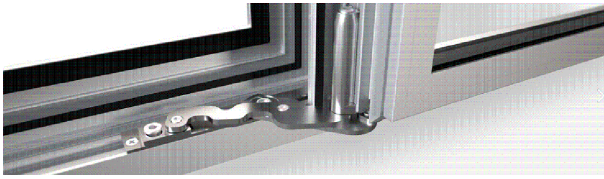

GIESSE GİZLİ MENTEŞE ÇİFT AÇILIM SETİ 100 kg
GIESSE HIDDEN HINGE TILT & TURN MECHANISM 100 kg

Renk / Colour : Siyah-Beyaz-Gri
Black-White-Grey

	ADDET NUMBER	07.06.011 TİP2 MAKAS (SAĞ) TYPE2 ARM	07.06.012 TİP2 MAKAS (SOL) TYPE2 ARM	07.06.005 KOL HANDLE	07.06.001 MEKANİZMA MECHANISM	07.06.010 İLAVE KİLİTLEME ADDITIONAL LOCKING	07.06.007 İLAVE MAKAS ADDITIONAL ARM
SAĞ RIGHT	L: 600-1000mm H: 600-1200mm	1	---	1	1	---	---
	L: 600-1000mm H: 1201-2500mm	1	---	1	1	1	---
	L: 1001-1500mm H: 600-1200mm	1	---	1	1	1	1
	L: 1001-1500mm H: 1201-2500mm	1	---	1	1	2	1
SOL LEFT	L: 600-1000mm H: 600-1200mm	---	1	1	1	---	---
	L: 600-1000mm H: 1201-2500mm	---	1	1	1	1	---
	L: 1001-1500mm H: 600-1200mm	---	1	1	1	1	1
	L: 1001-1500mm H: 1201-2500mm	---	1	1	1	2	1

PVC KANAL İÇİN ÇİFT AÇILIM SETLERİ (SAĞ) / TILT AND TURN OPENING SETS FOR PVC CHANNEL (RIGHT)

SAĞ / RIGHT			KANAT GENİŞLİĞİ / VENT WIDTH					
AÇIKLAMA DESCRIPTION	KANAT YÜKSEKLİĞİ VENT HEIGHT	KOD CODE	400-500 mm	501-750 mm	751-1000 mm	1001-1200 mm	1201-1450 mm	**1451-1600 mm
KANAT MAKAS SASH STAYS	480-2450 mm	07.30.004.	1					
		07.30.005.		1				
		07.30.006.			1			
		07.30.007.				1		
		07.30.008.					1	1
KASA MAKAS FRAME STAYS	480-2450 mm	07.30.033.	1					
		07.30.034.		1				
		07.30.035.			1	1		
		07.30.036.					1	1
ARKA KİLİTLEME LOCKING POINT HINGE SIDE	480-950 mm	07.30.016.				1		
		07.30.017.					1	
		07.30.018.						1
	951-1450 mm	07.30.016.	1	1	1	2	1	1
		07.30.017.					1	
		07.30.018.						1
	1451-1700 mm	07.30.016.				1		
		07.30.017.	1	1	1	1	2	1
		07.30.018.						1
	1701-1950 mm	07.30.016.				1		
		07.30.017.					1	
		07.30.018.	1	1	1	1	1	2
	1951-2450 mm	07.30.016.			1	1		
		07.30.017.					1	
		07.30.018.						1
07.30.019.		1	1	1	1	1	1	
İSPANYOLET ESPAGNOLETTE	480-590 mm	07.30.022.	1	1	1	1	1	1
	591-750 mm	07.30.023.	1	1	1	1	1	1
	751-1200 mm	07.30.024.	1	1	1	1	1	1
	1201-1450 mm	07.30.025.	1	1	1	1	1	1
	1451-1700 mm	07.30.028.	1	1	1	1	1	1
	1701-1950 mm	07.30.026.	1	1	1	1	1	1
	1951-2450 mm	07.30.027.	1	1	1	1	1	1
KİLİT KARŞILIK LOCKING PLATE	480-750 mm	07.27.011.	1	1	2	3	3	5
	751-950 mm	07.27.011.	2	2	3	4	4	6
	951-1450 mm	07.27.011.	3	3	4	6	6	8
	1451-1700 mm	07.27.011.	4	4	5	7	8	10
	1701-2450 mm	07.27.011.	5	5	6	8	8	10

AÇIKLAMA / DESCRIPTION	KOD / CODE	ADET / QUANTITY
KASA ALT MENTEŞE / FRAME BOTTOM HINGE	07.27.001.	1
KASA ÜST / ORTA MENTEŞE / FRAME TOP / MIDDLE HINGE	07.27.006.	1
MENTEŞE PİMİ / HINGE PIN	07.27.007.	1
KÖŞE ELEMANI 1 GÜVENLİKLİ PİM / CORNER PIECE	07.30.001.	1
İSPANYOLET ALT PARÇA / ESPAGNOLETTE BOTTOM PIECE	07.30.002.	1
PİVOT KARŞILIK / PIVOT LOCKING PLATE	07.30.003.	1
KANAT BANT MENTEŞE FRENLİ 9/20 ALU16 (SAĞ) VENT BOTTOM HINGE WITH BREAK 9/20 ALU16 (RIGHT)	07.27.002.	1
KANAT ALT MENTEŞE KAPAĞI SAĞ VENT BOTTOM HINGE CAP RIGHT	07.27.003.	1
KANAT BANT MENTEŞE KAPAĞI SAĞ VENT HINGE CAP RIGHT	07.27.004.	1

* SİPARİŞTE YUKARIDAKİ TABLODA BULUNAN ÜRÜNLERE SAĞA AÇILIM TEMEL SET İÇİNDEKİ PARÇALAR DAHİL EDİLMELİDİR.

THE PIECES IN THE RIGHT OPENING BASIC SET MUST BE ADDED THE PRODUCTS IN THE TABLE ABOVE WHEN ORDERING.

*KOL SETE DAHİL DEĞİLDİR.KOL SEÇENEKLERİ; 07.05.41 - 07.05.42

HANDLE IS NOT INCLUDED IN THE SET.HANDLE OPTIONS; 07.05.41 - 07.05.42

**1451-1600MM GENİŞLİĞİNDE EK OLARAK 07.30.009 MAKASI EKLENMELİDİR.

ADDITIONALLY 1451-1600 MM LENGTH 07.30.009. MUST BE ADDED.

PVC KANAL İÇİN ÇİFT AÇILIM SETLERİ (SOL) / TILT AND TURN OPENING SETS FOR PVC CHANNEL (LEFT)

SOL / LEFT			KANAT GENİŞLİĞİ / VENT WIDTH					
AÇIKLAMA DESCRIPTION	KANAT YÜKSEKLİĞİ VENT HEIGHT	KOD CODE	400-500 mm	501-750 mm	751-1000 mm	1001-1200 mm	1201-1450 mm	**1451-1600 mm
KANAT MAKAS SASH STAYS	480-2450 mm	07.30.004.	1					
		07.30.005.		1				
		07.30.006.			1			
		07.30.007.				1		
		07.30.008.					1	1
KASA MAKAS FRAME STAYS	480-2450 mm	07.30.029.	1					
		07.30.030.		1				
		07.30.031.			1	1		
		07.30.032.					1	1
ARKA KİLİTLEME LOCKING POINT HINGE SIDE	480-950 mm	07.30.016.				1		
		07.30.017.					1	
		07.30.018.						1
	951-1450 mm	07.30.016.	1	1	1	2	1	1
		07.30.017.					1	
		07.30.018.						1
	1451-1700 mm	07.30.016.				1		
		07.30.017.	1	1	1	1	2	1
		07.30.018.						1
	1701-1950 mm	07.30.016.				1		
		07.30.017.					1	
		07.30.018.	1	1	1	1	1	2
	1951-2450 mm	07.30.016.			1	1		
		07.30.017.					1	
		07.30.018.						1
07.30.019.		1	1	1	1	1	1	
İSPANYOLET ESPAGNOLETTE	480-590 mm	07.30.022.	1	1	1	1	1	1
	591-750 mm	07.30.023.	1	1	1	1	1	1
	751-1200 mm	07.30.024.	1	1	1	1	1	1
	1201-1450 mm	07.30.025.	1	1	1	1	1	1
	1451-1700 mm	07.30.028.	1	1	1	1	1	1
	1701-1950 mm	07.30.026.	1	1	1	1	1	1
	1951-2450 mm	07.30.027.	1	1	1	1	1	1
KİLİT KARŞILIK LOCKING PLATE	480-750 mm	07.27.011.	1	1	2	3	3	5
	751-950 mm	07.27.011.	2	2	3	4	4	6
	951-1450 mm	07.27.011.	3	3	4	6	6	8
	1451-1700 mm	07.27.011.	4	4	5	7	8	10
	1701-2450 mm	07.27.011.	5	5	6	8	8	10

AÇIKLAMA / DESCRIPTION	KOD / CODE	ADET / QUANTITY
KASA ALT MENTEŞE / FRAME BOTTOM HINGE	07.27.001.	1
KASA ÜST / ORTA MENTEŞE FRAME TOP / MIDDLE HINGE	07.27.006.	1
MENTEŞE PİMİ / HINGE PIN	07.27.007.	1
KÖŞE ELEMANI 1 GÜVENLİKLİ PİM / CORNER PIECE	07.30.001.	1
İSPANYOLET ALT PARÇA / ESPAGNOLETTE BOTTOM PIECE	07.30.002.	1
PİVOT KARŞILIK / PIVOT LOCKING PLATE	07.30.003.	1
KANAT BANT MENTEŞE FRENLİ 9/20 ALU16 (SOL) VENT BOTTOM HINGE WITH BREAK 9/20 ALU16 (LEFT)	07.27.013.	1
KANAT ALT MENTEŞE KAPAĞI SOL VENT BOTTOM HINGE CAP LEFT	07.27.014.	1
KANAT BANT MENTEŞE KAPAĞI SOL VENT HINGE CAP LEFT	07.27.015.	1

* SİPARİŞTE YUKARIDAKİ TABLODA BULUNAN ÜRÜNLERE SOLA AÇILIM TEMEL SET İÇİNDEKİ PARÇALAR DAHİL EDİLMELİDİR.

THE PIECES IN THE LEFT OPENING BASIC SET MUST BE ADDED THE PRODUCTS IN THE TABLE ABOVE WHEN ORDERING.

*KOL SETE DAHİL DEĞİLDİR.KOL SEÇENEKLERİ;
07.05.41 - 07.05.42

HANDLE IS NOT INCLUDED IN THE SET.HANDLE OPTIONS;
07.05.41 - 07.05.42

**1451-1600MM GENİŞLİĞİNDE EK OLARAK 07.30.009 MAKASI EKLENMELİDİR.
ADDITIONALLY 1451-1600 MM LENGTH 07.30.009. MUST BE ADDED.

PVC KANAL İÇİN TEK AÇILIM SETLERİ (SAĞ / SOL) / SINGLE OPENING SETS FOR PVC CHANNEL (RIGHT / LEFT)

AÇIKLAMA DESCRIPTION	KANAT YÜKSEKLİĞİ SASH HEIGHT H (mm)	KOD CODE	SAĞ RIGHT	SOL LEFT
GU KASA ALT MENTEŞE GU BOTTOM HINGE FRAME	501-2200 mm	07.27.001	1	1
GU KASA BANT MENTEŞE FRENLI-SAĞ GU REBATE CORNER WITH BRAKE-RIGHT		07.27.002	1	--
GU KASA ALT MENTEŞE KAPAĞI-SAĞ GU BOTTOM HINGE CAP SASH-RIGHT		07.27.003	1	--
GU KANAT BANT MENTEŞE FRENLI-SOL GU REBATE CORNER HINGE WITH BRAKE-LEFT		07.27.013	--	1
GU KANAT ALT MENTEŞE KAPAĞI-SOL GU BOTTOM HINGE CAP SASH-LEFT		07.27.014	--	1
GU KASA ÜST/ORTA MENTEŞE-PİMSİZ GU FRAME TOP/MIDDLE HINGE-WITHOUT PIN		07.27.006	1	1
GU MENTEŞE PİMİ GU PIN FOR HINGE		07.27.007	1	1
GU UNIJET D KANAT ÜST MENTEŞE GU UNIJET D-TOP HINGE 9MM		07.27.005	1	1
GU KANAT ORTA MENTEŞE 12/20 GU MIDDLE HINGE SASH 12/20		07.27.008	1	1
GU KASA BANT MENTEŞE KAPAK TK.SAĞ GU REBATE CORNER HINGE CAP-RIGHT		07.27.004	1	--
GU KANAT BANT MENTEŞE KAPAK TK. SOL GU REBATE CORNER HINGE CAP-LEFT		07.27.015	--	1
GU ORTA MENTEŞE KAPAK TAKIMI GU MIDDLE HINGE CAP		07.27.009	1	1
GU KİLİT KARŞILIK GU LOCKING PLATE		07.27.011	2	2
GU İSPANYOLET GU ESPAGNOLETTE	501-600 mm	07.27.045	1	1
	601-800 mm	07.27.018	1	1
	801-900 mm	07.27.020	1	1
	901-1000 mm	07.27.021	1	1
	1001-1100 mm	07.27.016	1	1
	1101-1200 mm	07.27.010	1	1
	1201-1300 mm	07.27.022	1	1
	1301-1400 mm	07.27.023	1	1
	1401-1600 mm	07.27.024	1	1
	1601-1800 mm	07.27.024	1	1
	1801-2000 mm	07.27.025	1	1
2001-2200 mm	07.27.026	1	1	

*KOL SETE DAHİL DEĞİLDİR.KOL SEÇENEKLERİ; 07.05.41 - 07.05.42

HANDLE IS NOT INCLUDED IN THE SET.HANDLE OPTIONS; 07.05.41 - 07.05.42

*PVC KANALLI TEK AÇILIM SETİ İÇİN KANAT GENİŞLİĞİ L<1000MM OLMALIDIR.

DAHA BÜYÜK ÖLÇÜLER İÇİN TEKNİK OFİS İLE İRTİBATA GEÇİLEBİLİR.

PERIMETRIC GROOVE (16MM) SIDE HUNG OPENING KIT FOR L<1000MM. FOR L>1000MM PLEASE CONTACT TECHNICAL OFFICE.

PVC KANALLI PASİF KANAT AKSESUAR SEÇİM TABLOSU / PVC CHANNEL SECONDARY SASH LOCKING KIT TABLE

AÇIKLAMA DESCRIPTION	KOD CODE	KANAT YÜKSEKLİĞİ / SASH HEIGHT H (mt)			
		781-1450 mm		1451-2450 mm	
		SAĞ RIGHT	SOL LEFT	SAĞ RIGHT	SOL LEFT
GU KASA ALT MENTEŞE GU BOTTOM HINGE FRAME	07.27.001	1	1	1	1
GU KASA BANT MENTEŞE FRENLI-SAĞ GU REBATE CORNER WITH BRAKE-RIGHT	07.27.002	1	--	1	--
GU KASA BANT MENTEŞE KAPAK TK.SAĞ GU REBATE CORNER HINGE CAP-RIGHT	07.27.004	1	--	1	--
GU KANAT BANT MENTEŞE FRENLI-SOL GU REBATE CORNER HINGE WITH BRAKE-LEFT	07.27.013	--	1	--	1
GU KANAT BANT MENTEŞE KAPAK TK. SOL GU REBATE CORNER HINGE CAP-LEFT	07.27.015	--	1	--	1
GU KASA ÜST/ORTA MENTEŞE-PIMSİZ GU FRAME TOP/MIDDLE HINGE-WITHOUT PIN	07.27.006	1	1	1	1
GU MENTEŞE PİMİ GU PIN FOR HINGE	07.27.007	1	1	1	1
GU UNIJET D KANAT ÜST MENTEŞE GU UNIJET D-TOP HINGE 9MM	07.27.005	1	1	1	1
GU GİZLİ ORTA MENTEŞE-KANAT PARÇ. GU CONCEALED SASH SUPPORT	07.27.046	1	1	2	2
GU PLASTİK GİZLİ BASKI-KASA PARÇ. GU CONCEALED FRAME SUPPORT	07.27.047	1	1	2	2
GU ZH PASİF KANAT FİŞEK TAKIMI GU ZH SECOND SASH BOLT	07.27.038	1	1	1	1
GU FİŞEK SÜRGÜ KARŞILIK, AYARSIZ GU LOCKING PLATE FOR BOLT	07.27.039	2	2	2	2

AÇIKLAMA DESCRIPTION	KANAT YÜKSEKLİĞİ SASH HEIGHT H (mt)	KOD CODE	SAĞ RIGHT	SOL LEFT
GU İSPANYOLET GU ESPAGNOLETTE	781-950 mm	07.27.036	1	1
	951-1450 mm	07.27.019	1	1
	1451-1950 mm	07.27.035	1	1
	1951-2450 mm	07.27.047	1	1

AÇIKLAMA DESCRIPTION	KOD CODE	KANAT GENİŞLİĞİ / VENT WIDTH			
		300-750mm	751-950mm	951-1200mm	1201-1600mm
GU KİLİT KARŞILIK GU LOCKING PLATE	07.27.011	1	1	1	1
GU PASİF KANAT KÖŞE DÖNÜŞ KISA 215MM GU SECONDARY SASH CORNER DRIVE SHORT 215MM	07.27.059	1			
GU PASİF KANAT KÖŞE DÖNÜŞ UZUN 530MM GU SECONDARY SASH CORNER DRIVE LONG 530MM	07.27.060		1		
GU PASİF KANAT KÖŞE DÖNÜŞ UZUN 740MM GU SECONDARY SASH CORNER DRIVE LONG 740MM	07.27.061			1	
GU PASİF KANAT KÖŞE DÖNÜŞ UZUN 1050MM GU SECONDARY SASH CORNER DRIVE LONG 1050MM	07.27.062				1

PENCERE KOLLARI / WINDOW HANDLES

<p>07.05.25 GIESSE İSPANYOLET KOL (ÇİFT DİLLİ) GIESSE HANDLE FOR WINDOWS (DOUBLE RAIL) Renk / Colour : Siyah-Beyaz-Gri Black-White-Grey</p> <p>UNI CEI EN ISO / IEC 17050</p>	<p>07.05.33 GIESSE ANAHTARLI İSPANYOLET KOL (ÇİFT DİLLİ) GIESSE KEY HANDLE FOR WINDOWS (DOUBLE RAIL) Renk / Colour : Siyah-Beyaz-Gri Black-White-Grey</p>
<p>07.25.01 GIESSE TIJ BAĞLANTI PARÇASI GIESSE CONNECTION ROD Renk / Colour : Siyah / Black Malzeme / Material : Polyamid / Polyamide</p> <p>07.05.25 , 07.05.33 ve 07.05.34 Kol için / For Handle 07.05.25 , 07.05.33 and 07.05.34</p>	<p>07.05.34 GIESSE SÖKÜLEBİLİR KOL GÖVDESİ (ÇİFT DİLLİ) GIESSE REMOVABLE HANDLE BODY (DOUBLE RAIL) Renk / Colour : Siyah-Beyaz-Gri Black-White-Grey</p>
<p>07.05.29 RESCARA GLOBAL ANAHTARLI PENCERE KOLU (TEK DİLLİ) RESCARA GLOBAL KEY HANDLE FOR WINDOWS (SINGLE RAIL) Renk / Colour : Siyah-Beyaz-Gri Black-White-Grey</p> <p>EN 1670</p>	<p>07.05.35 GIESSE SÖKÜLEBİLİR KOL GIESSE REMOVABLE HANDLE Renk / Colour : Siyah Black</p>
<p>07.13.07 RESCARA KOL BAĞLANTI PARÇASI RESCARA CONNECTION PART FOR HANDLE Malzeme / Material : Zamak / Zamak</p> <p>07.05.28, 07.05.29 Kol için / For Handle 07.05.28, 07.05.29</p>	<p>07.05.30 RESCARA GLOBAL SÖKÜLEBİLİR KOL GÖVDESİ (ÇİFT DİLLİ) RESCARA GLOBAL REMOVABLE HANDLE BODY (DOUBLE RAIL) Renk / Colour : Siyah-Beyaz-Gri Black-White-Grey</p> <p>EN 1670</p>
<p>07.05.28 RESCARA GLOBAL PENCERE KOLU (TEK DİLLİ) RESCARA GLOBAL HANDLE FOR WINDOWS (SINGLE RAIL) Renk / Colour : Siyah-Beyaz-Gri Black-White-Grey</p> <p>EN 1670</p>	<p>07.05.31 RESCARA SÖKÜLEBİLİR KOL RESCARA REMOVABLE HANDLE Renk / Colour : Siyah / Black</p> <p>EN 1670</p>
<p>07.05.32 RESCARA GLOBAL PENCERE KOLU (ÇİFT DİLLİ) RESCARA GLOBAL HANDLE FOR WINDOWS (DOUBLE RAIL) Renk / Colour : Siyah-Beyaz-Gri Black-White-Grey</p> <p>EN 1670, 13126-8</p>	<p>07.13.08 RESCARA KOL BAĞLANTI PARÇASI RESCARA CONNECTION PART FOR HANDLE Renk / Colour : Siyah / Black Malzeme / Material : PVC</p> <p>07.05.30, 07.05.32 Kol için / For Handle 07.05.30, 07.05.32</p>

HOLD LINE PENCERE KOLLARI / HOLDLINE WINDOW HANDLES

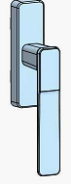

07.05.84.

HOLD LINE ÇİFT MAÇALI KOL
HOLD LINE FORK HANDLE

Renk / Colour : Boyalı-Siyah-Ham
Colour-Black-Raw



07.05.83.

HOLD LINE ÇİFT MAÇALI KİLİTLİ KOL
HOLD LINE FORK HANDLE WITH KEY

Renk / Colour : Boyalı-Siyah-Ham
Colour-Black-Raw

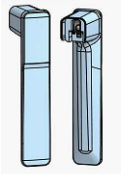

07.05.81.

HOLD LINE ÇİFT MAÇALI SÖKÜLEBİLİR KOL SAPI
HOLD LINE FORK DETACHABLE HANDLE ARM

Renk / Colour : Boyalı-Siyah-Ham
Colour-Black-Raw

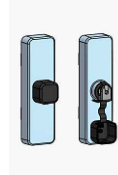

07.05.80.

HOLD LINE ÇİFT MAÇALI SÖKÜLEBİLİR KOL
GÖVDESİ TEK EKSEN
HOLD LINE FORK DETACHABLE HANDLE ARM
BODY SINGLECASEMENT

Renk / Colour : Boyalı-Siyah-Ham
Colour-Black-Raw



07.25.16.

KARE MİLLİ GEARBOX
SPINDLE GEARBOX

Renk / Colour : Boyalı-Siyah-Ham
Colour-Black-Raw



07.05.87.

HOLD LINE KARE MİLLİ SEKUSTİK KİLİTLİ KOL
HOLD LINE SPINDLE SECUSTUC HANDLE WITH KEY

Renk / Colour : Boyalı-Siyah-Ham
Colour-Black-Raw

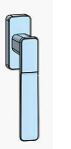

07.05.85.

HOLD LINE KARE MİLLİ SEKUSTİK KOL
HOLD LINE SPINDLE SECUSTUC HANDLE

Renk / Colour : Boyalı-Siyah-Ham
Colour-Black-Raw

PVC KANAL İÇİN PENCERE AÇILIM SETLERİ / WINDOW OPENING SETS FOR PVC CHANNEL



07.05.41

RESCARA AKUSTİK PENCERE KOLU
RESCARA ACOUSTIC HANDLE

Renk / Colour : Siyah-Beyaz-Gri
Black-White-Grey







07.05.42

RESCARA AKUSTİK PENCERE KOLU
RESCARA ACOUSTIC HANDLE

Renk / Colour : Siyah-Beyaz-Gri
Black-White-Grey

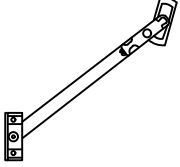
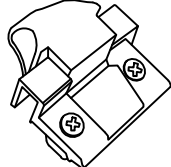

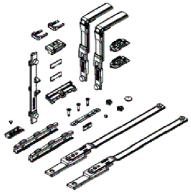

İSPANYOLET KİLİTLEME PARÇALARI / LOCKING KITS

 <p>07.13.03 PİM LOCK PIN Malzeme / Material : Zamak / Zamak</p>	 <p>07.13.06 GIESSE PİM GIESSE ADJUSTABLE LOCKING PAWL Malzeme / Material : Zamak / Zamak</p>
 <p>07.09.07 GIESSE AYARLI PİM KARŞILIĞI GIESSE ADJUSTABLE SINGLE STRIKER Malzeme / Material : Zamak / Zamak</p>	 <p>07.09.08 GIESSE ARKA KİLİTLEME GIESSE BURGLAR BOLT Malzeme / Material : Zamak / Zamak</p>
 <p>18.06.01 GIESSE KARŞILIK GIESSE STRIKER Malzeme / Material : Paslanmaz çelik ve zamak Stainless steel and zamak</p>	 <p>07.09.11 RESCARA SABİT KARŞILIK RESCARA FIXED STRIKER Malzeme / Material : Zamak / Zamak</p>
 <p>18.07.01 GIESSE SÜRGÜ SETİ GIESSE BOLT FOR LEAF Malzeme / Material : Zamak ve polyamid Zamak and polyamide Pasif kanat için / For secondary sash</p>	 <p>07.09.12 RESCARA AYARLI KARŞILIK RESCARA ADJUSTABLE STRIKER Malzeme / Material : Zamak / Zamak</p>
 <p>07.21.03 RESCARA KÖŞE DÖNME RESCARA CORNER DRIVE Malzeme / Material : Zamak / Zamak</p>	 <p>07.21.02 GIESSE KÖŞE DÖNME GIESSE CORNER DRIVE Malzeme / Material : Zamak / Zamak</p>
 <p>07.09.13 RESCARA ARKA KİLİTLEME RESCARA BURGLAR BOLT Malzeme / Material : Zamak / Zamak</p>	 <p>07.06.78 RESCARA MICROVENTİLASYON RESCARA MICROVENTILATION Malzeme / Material : Zamak / Zamak</p>

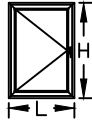
 <p>07.07.02 VASİSTAS MAKAS ARM FOR BOTTOM-HUNG WINDOWS</p> <p>Renk / Colour : Siyah-Beyaz-Gri Black-White-Grey</p>	 <p>07.08.01 RESCARA VASİSTAS MANDAL RESCARA DEVICE FOR CLOSING BOTTOM-HUNG WINDOWS</p> <p>Renk / Colour : Siyah-Beyaz-Gri Black-White-Grey</p>
 <p>07.07.08 SINIRLAYICI MAKAS LIMITER</p> <p>Malzeme / Material : Gümüş- Paslanmaz Çelik Silver - Stainless Steel</p>	 <p>07.07.09 GIESSE VASİSTAS MAKAS GIESSE ARM FOR BOTTOM-HUNG WINDOWS</p> <p>Renk / Colour : Siyah-Beyaz-Gri Black-White-Grey</p>
 <p>07.07.11 GIESSE VASİSTAS PENCERE SETİ GIESSE BOTTOM HUNG WINDOW SET</p> <p>Kol ve menteşe sete dahil değildir. Handle and hinge is not included in the set</p>	 <p>11.02.34 RESCARA KANAT DESTEK TAKOZU RESCARA VENT SUPPORT PIECE</p> <p>Malzeme / Material : PVC Renk / Colour : Siyah/Black</p>







ÇİFT DİLLİ KOL VE KİLİTLEME SETİ SEÇİM TABLOSU
DOUBLE RAILED HANDLE AND LOCKING KIT TABLE







			TEMEL SET MAIN SET	İLAVE ÜRÜNLER ADDITIONAL PRODUCTS	
KOD CODE	AÇIKLAMA DESCRIPTION	ÜRÜN RESMİ PRODUCT IMAGE	H<1200mm L<1000mm	1200mm < H < 2700 mm	1000mm < L < 1400 mm
07.05.25	GIESSE ÇİFT DİLLİ KOL GIESSE DOUBLE RAIL HANDLE		1		
07.25.01	GIESSE KOL BAĞLANTISI GIESSE ROD CONNECTION PIECES		1		
07.13.06	GIESSE AYARLI PİM GIESSE ADJUSTABLE LOCKING PAWL		2	2	2
07.09.11	RESCARA SABİT KARŞILIK RESCARA FIXED STRIKER		2	2	2
07.09.07	GIESSE AYARLI PİM KARŞILIĞI GIESSE ADJUSTABLE SINGLE STRIKER				2
07.21.02	GIESSE KÖŞE DÖNME GIESSE/RESCARA CORNER DRIVE				2
11.02.34	RESCARA KANAT DESTEK TAKOZU RESCARA VENT SUPPORT PIECE		1		

***Giesse kol ve kilitleme aksesuarları 25 I 07 tij profili ile kullanılmalıdır.

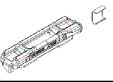
Giesse handle and locking accessories should be used with 25 I 07 rod profile

TEK DİLLİ KOL VE KİLİTLEME SETİ SEÇİM TABLOSU SINGLE RAILED HANDLE AND LOCKING KIT TABLE					
			TEMEL SET MAIN SET	İLAVE ÜRÜNLER ADDITIONAL PRODUCTS	
KOD CODE	AÇIKLAMA DESCRIPTION	ÜRÜN RESMİ PRODUCT IMAGE	H<1200mm L<1000mm	1200mm < H < 2700 mm	1000mm < L < 1400 mm
07.05.28 07.05.29	RESCARA TEK DİLLİ KOL RESCARA SINGLE RAIL HANDLE		1		
07.13.07	RESCARA KOL BAĞLANTI PARÇASI RESCARA CONNECTION PART FOR HANDLE		1		
07.13.06	GIESSE AYARLI PİM GIESSE ADJUSTABLE LOCKING PAWL		2	2	2
07.09.11	RESCARA SABİT KARŞILIK RESCARA FIXED STRIKER		2	2	2
07.09.12	RESCARA AYARLI KARŞILIK RESCARA ADJUSTABLE STRIKER				2
07.21.03	RESCARA KÖŞE DÖNME RESCARA CORNER DRIVE				2
11.02.34	RESCARA KANAT DESTEK TAKOZU RESCARA VENT SUPPORT PIECE		1		

ÇİFT/TEK AÇILIM PASİF KANAT AKSESUAR SEÇİM TABLOSU SECONDARY SASH LOCKING KIT TABLE					
			TEMEL SET MAIN SET	İLAVE ÜRÜNLER ADDITIONAL PRODUCTS	
KOD CODE	AÇIKLAMA DESCRIPTION	ÜRÜN RESMİ PRODUCT IMAGE	H<1200mm L<1000mm	1200mm < H < 2700 mm	1000mm < L < 1400 mm
18.07.01	GIESSE SÜRGÜ SETİ GIESSE BOLT FOR LEAF		1		
18.06.01	GIESSE KARŞILIK GIESSE STRIKER		2		
07.21.02	GIESSE KÖŞE DÖNME PARÇASI GIESSE CORNER DRIVE				2
07.09.07	GIESSE AYARLI PİM KARŞILIĞI GIESSE ADJUSTABLE SINGLE STRIKER				2
07.09.08	GIESSE ARKA KİLİTLEME GIESSE BURGLAR BOLT			1	

***Giesse kol ve kilitleme aksesuarları 25 I 07 tij profili ile kullanılmalıdır.
Giesse handle and locking accessories should be used with 25 I 07 rod profile

KAPI KOLLARI / DOOR HANDLES



07.14.06

GIESSE KAPI KOLU
GIESSE DOOR HANDLE

Renk / Colour : Siyah-Beyaz-Gri
Black-White-Grey



07.14.07

RESCARA GLOBAL KAPI KOLU
RESCARA GLOBAL DOOR HANDLE

Renk / Colour : Siyah-Beyaz-Gri
Black-White-Grey



07.14.08

RESCARA MULETA KAPI KOLU
RESCARA GLOBAL DOOR HANDLE

Renk / Colour : Siyah-Beyaz-Gri
Black-White-Grey

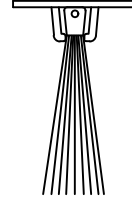

17.02.01

KAPI ALTI FIRÇASI
BRUSH FOR DOORS

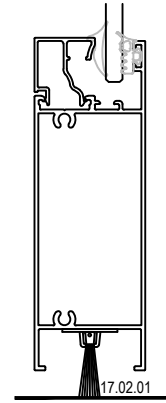

Malzeme / Material : Polipropilen / Polypropylene





17.02.01

Ölçek/Scale: x

KAPI KOLLARI / DOOR HANDLES

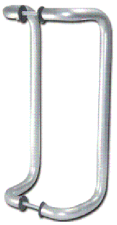
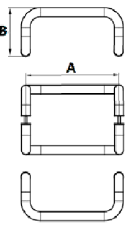

	<p>07.17.19 AKBANK KAPI KOLU DOOR HANDLE</p> <p>Renk / Colour : Siyah-Beyaz-Gri-Eloksal Black-White-Grey-Anodized</p>		<p>07.13.10 AKBANK KOL APARATI DOOR HANDLE</p> <p>Renk / Colour : Siyah-Beyaz-Gri-Eloksal Black-White-Grey-Anodized</p>
<p>Ölçüler / Dimensions: H:200 cm</p>			

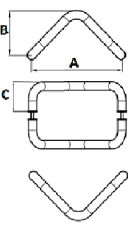
		<p>KIVRIK KOL DOOR HANDLE</p> <p>Renk / Colour : Siyah-Beyaz-Eloksal Black-White-Anodized</p>	
KOD CODE	Ø (mm)	A (mm)	B (mm)
07.17.10	25	200	130
07.17.11	25	300	130
07.17.02	25	400	130
07.17.27	25	500	160

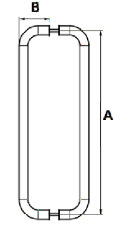
		<p>V KOL DOOR HANDLE</p> <p>Renk / Colour : Siyah-Beyaz-Eloksal Black-White-Anodized</p>		
KOD CODE	Ø (mm)	A (mm)	B (mm)	C (mm)
07.17.06	25	200	130	80
07.17.29	25	250	130	80
07.17.30	25	300	130	80
07.17.31	30	400	160	100

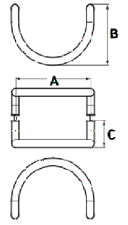

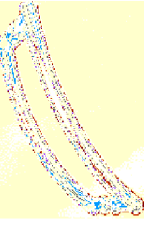

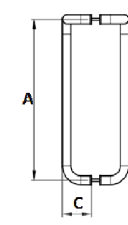

		<p>U KOL DOOR HANDLE</p> <p>Renk / Colour : Siyah-Beyaz-Eloksal Black-White-Anodized</p>	
KOD CODE	Ø (mm)	A (mm)	B (mm)
07.17.08	25	200	80
07.17.35	25	300	80
07.17.36	30	400	100

		<p>YARIM AY KOL DOOR HANDLE</p> <p>Renk / Colour : Siyah-Beyaz-Eloksal Black-White-Anodized</p>		
KOD CODE	Ø (mm)	A (mm)	B (mm)	C (mm)
07.17.32	25	200	130	80
07.17.20	25	300	130	80
07.17.33	30	350	160	100

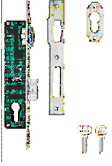
		<p>YAY KOL DOOR HANDLE</p> <p>Renk / Colour : Siyah-Beyaz-Eloksal Black-White-Anodized</p>	
KOD CODE	Ø (mm)	A (mm)	B (mm)
07.17.37	80	400	350
07.17.22	80	500	450
07.17.38	80	600	550
07.17.39	80	700	650
07.17.40	80	800	750

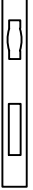
		<p>BASTON KOL DOOR HANDLE</p> <p>Renk / Colour : Siyah-Beyaz-Eloksal Black-White-Anodized</p>		
KOD CODE	Ø (mm)	A (mm)	B (mm)	C (mm)
07.17.23	25	900	180	80
07.17.34	25	1000	180	80

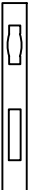
KAPI KİLİTLERİ / DOOR LOCKS

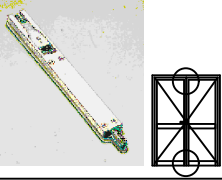
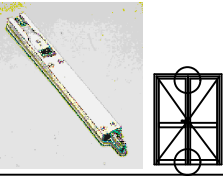
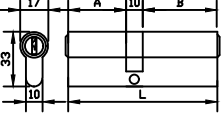
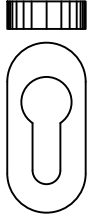
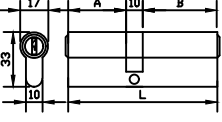
 <p>18.01.09 MAKARALI KİLİT MORTISE LOCK (WITH ROLLER)</p>	 <p>18.01.08 DİLLİ KİLİT MORTISE LOCK</p>						
 <p>18.02.24 MAKARALI KİLİT KARŞILIĞI STRIKER FOR ROLLER LOCK</p>	 <p>18.02.25 DİLLİ KİLİT KARŞILIĞI STRIKER FOR MORTISE LOCK</p>						
 <p>18.02.12 MAKARALI KİLİT KARŞILIĞI STRIKER FOR ROLLER LOCK</p>	 <p>18.02.11 DİLLİ KİLİT KARŞILIĞI STRIKER FOR MORTISE LOCK</p>						
 <p>18.03.01 KAPI SÜRGÜSÜ (UZUN) BOLT FOR DOORS (LONG)</p>	 <p>18.03.06 KAPI SÜRGÜSÜ (KISA) BOLT FOR DOORS (SHORT)</p>						
 <p>18.04.03 BAREL CYLINDER</p> <p>Malzeme / Material : Krom-Nikel / Chrome-Nickel</p> <table border="1"><thead><tr><th>A</th><th>B</th><th>L</th></tr></thead><tbody><tr><td>26</td><td>32</td><td>68</td></tr></tbody></table>	A	B	L	26	32	68	 <p>18.05.02 BAREL AYNASI CYLINDER COVER</p> <p>Renk / Colour : Siyah-Beyaz-Grey Black-White-Grey</p>
A	B	L					
26	32	68					
 <p>18.04.07 BAREL CYLINDER</p> <p>Malzeme / Material : Krom-Nikel / Chrome-Nickel</p> <table border="1"><thead><tr><th>A</th><th>B</th><th>L</th></tr></thead><tbody><tr><td>26</td><td>26</td><td>62</td></tr></tbody></table>	A	B	L	26	26	62	
A	B	L					
26	26	62					

**İÇE AÇILIM BİNİLİ DETAY İÇİN
**INWARD OPENING DOOR DETAIL

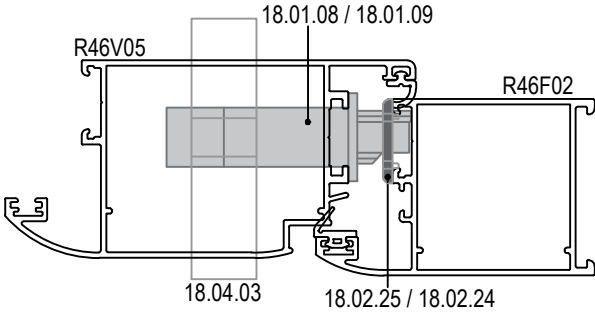

**İÇE AÇILIM BİNİLİ ORTA BİRLEŞİM DETAYI İÇİN
**INWARD OPENING DOOR DETAIL

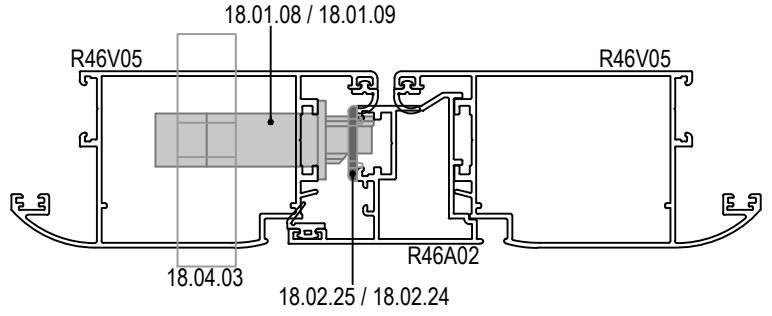

**İÇE AÇILIM HEMYÜZ ADAPTÖRLÜ (R46 A 04) DETAY İÇİN
**INWARD OPENING FLUSH DOOR ADAPTER DETAIL (R46 A 04)

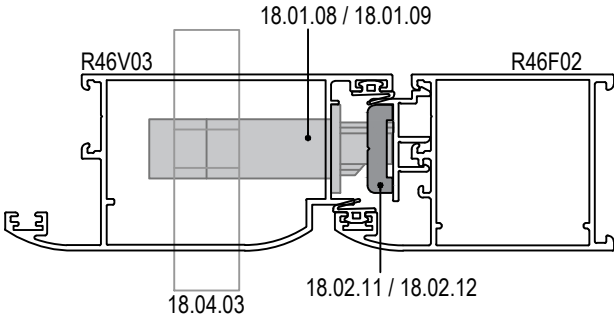

**DIŞA AÇILIM HEMYÜZ ADAPTÖRLÜ (R46 A 04) DETAY İÇİN
**OUTWARD OPENING FLUSH DOOR DETAIL (R46 A 04)

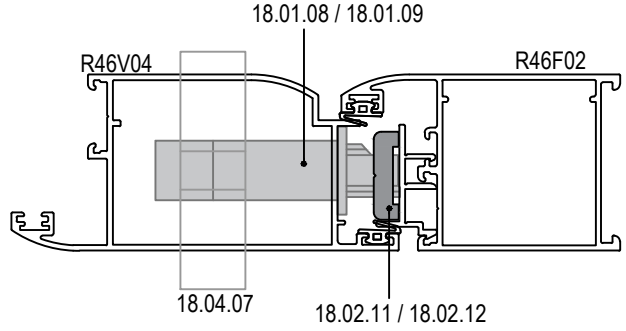

**DIŞA AÇILIM HEMYÜZ ORTA BİRLEŞİM DETAYI İÇİN (R46 A 03)
**OUTWARD OPENING FLUSH DOOR ADAPTER DETAIL (R46 A 03)

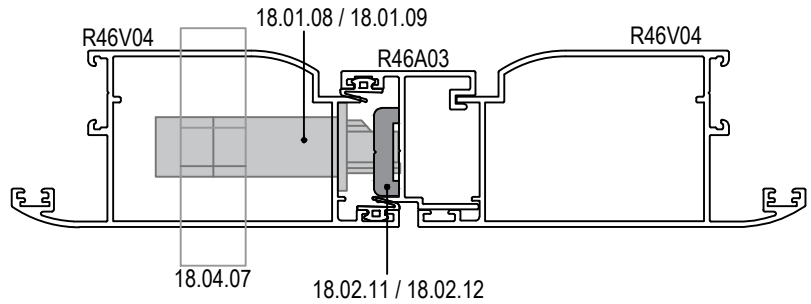

Ölçek/Scale: 1/2